

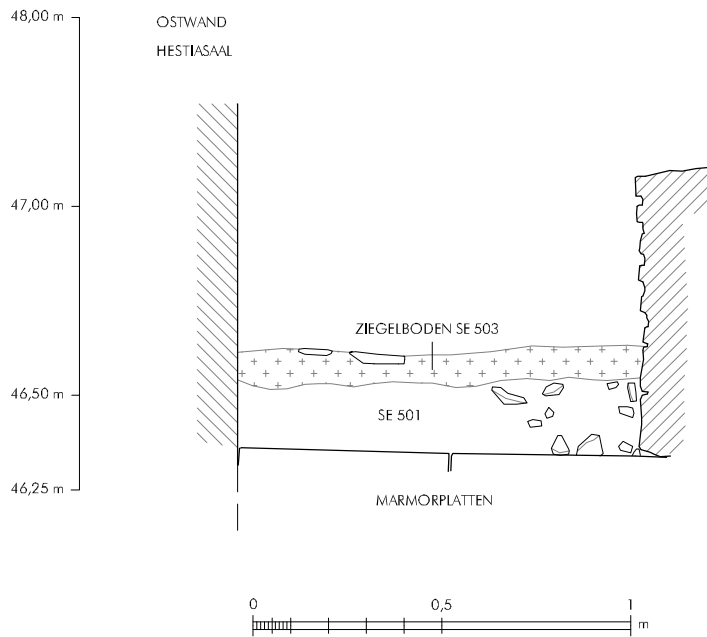

1 Schnitt 5/07. Endsituation von Süden

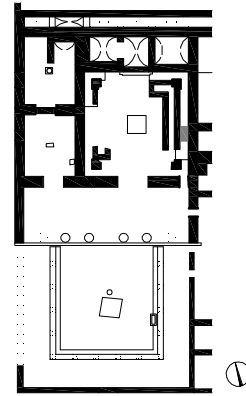

2 Schnitt 5/07. Nordprofil



PRYTANEION
Schnitt 5/07 - Südprofil
gezeichnet
B. Stark
grafische Bearbeitung
L. Zabrana

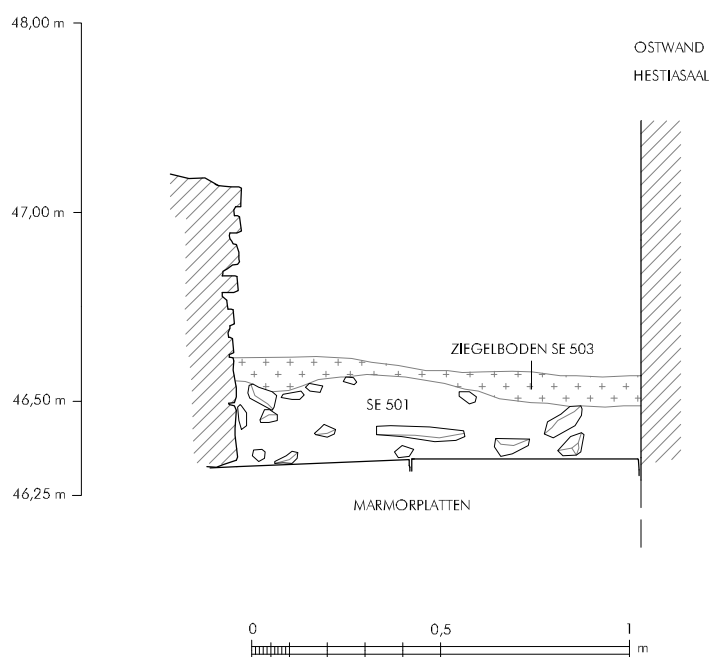

PRYTANEION
Schnitt 5/07 - Nordprofil
gezeichnet
B. Stark
grafische Bearbeitung
L. Zabrana

1 Schnitt 5/07. Süd- und Nordprofil (1:20)



1 Schnitt 1/08. Ausgangssituation von Westen



2 Schnitt 1/08. Endsituation von Westen

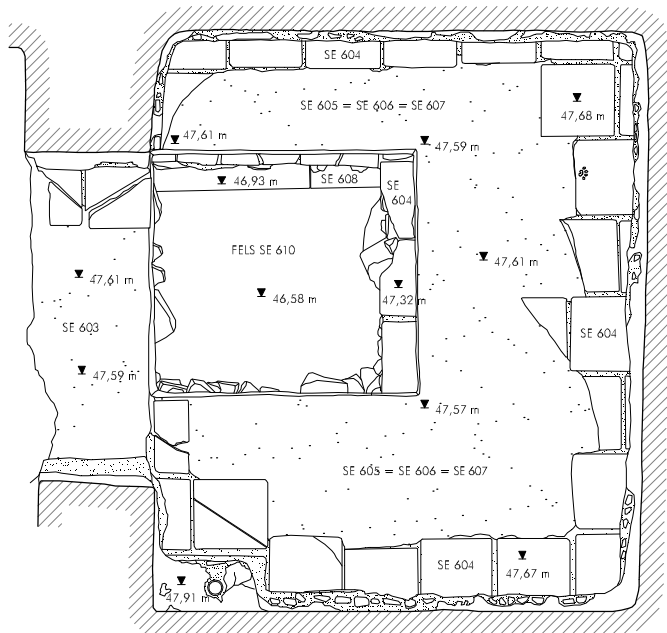
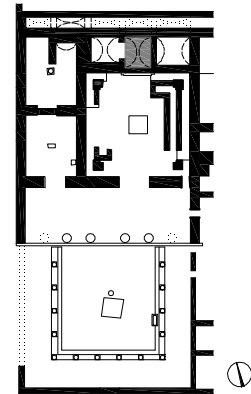

NORDWAND HESTIASAAL

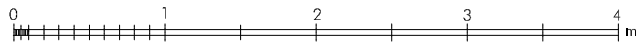

PRYTANEION
 Schnitt 1/08 - Planum Endzustand
 gezeichnet
 B. Stark
 grafische Bearbeitung
 L. Zabrena

1 Schnitt 1/08. Planum Endzustand (1:50)



1 Schnitt 1/08. Nordprofil

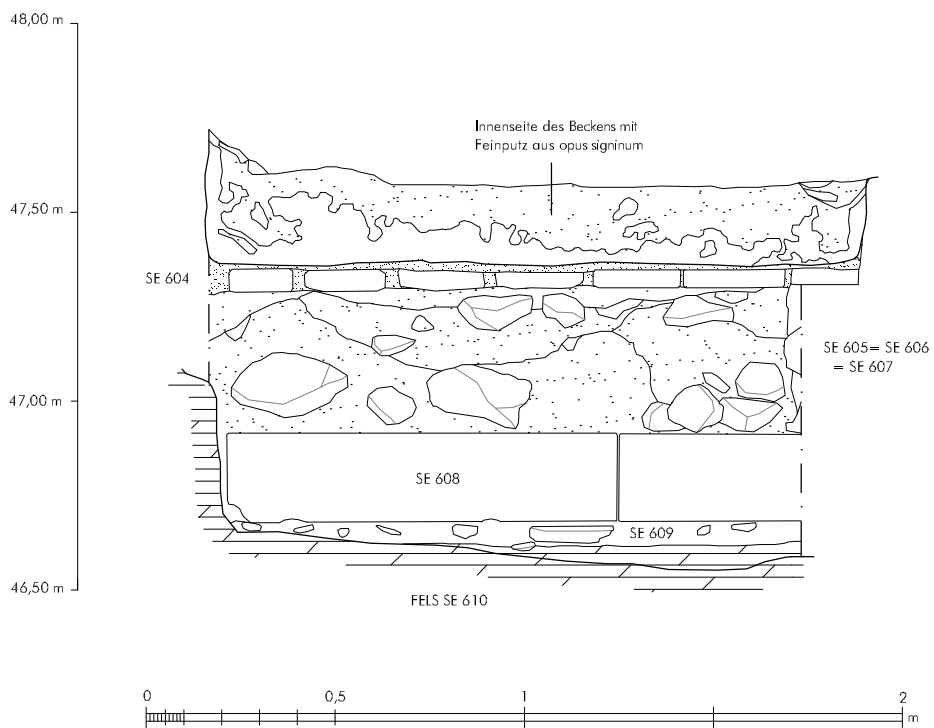
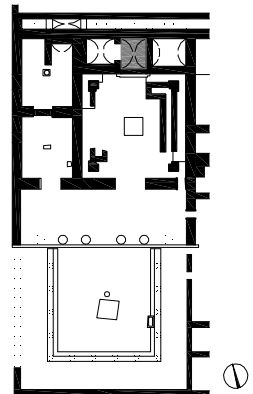

PRYTANEION
Schnitt 1/08 - Nordprofil
gezeichnet
B. Stark
grafische Bearbeitung
L. Zabrana

2 Schnitt 1/08. Nordprofil (1:20)



1 Schnitt 1/08. Ostprofil

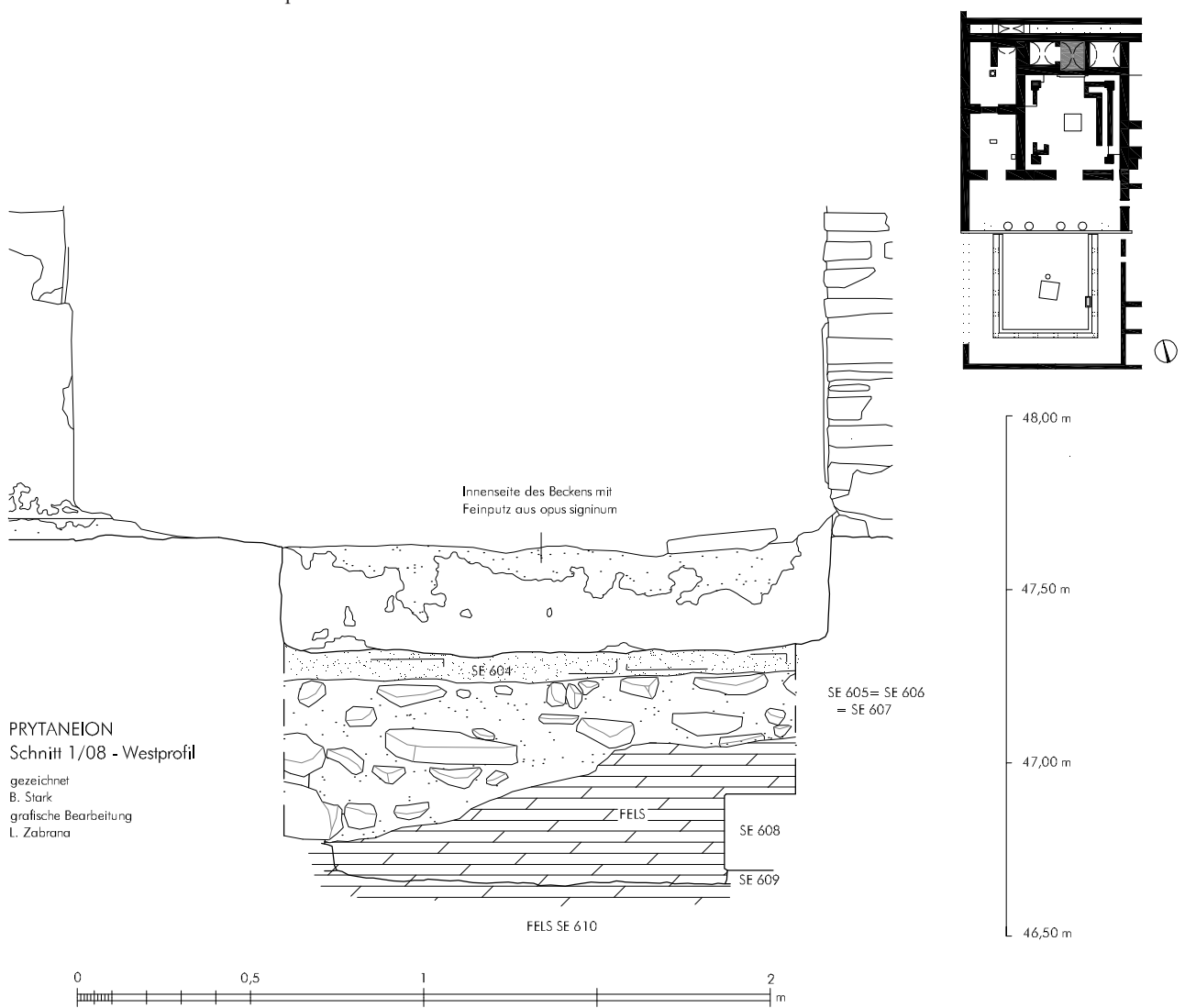

2 Schnitt 1/08. Ostprofil (1:20)



1 Schnitt 1/08. Westprofil

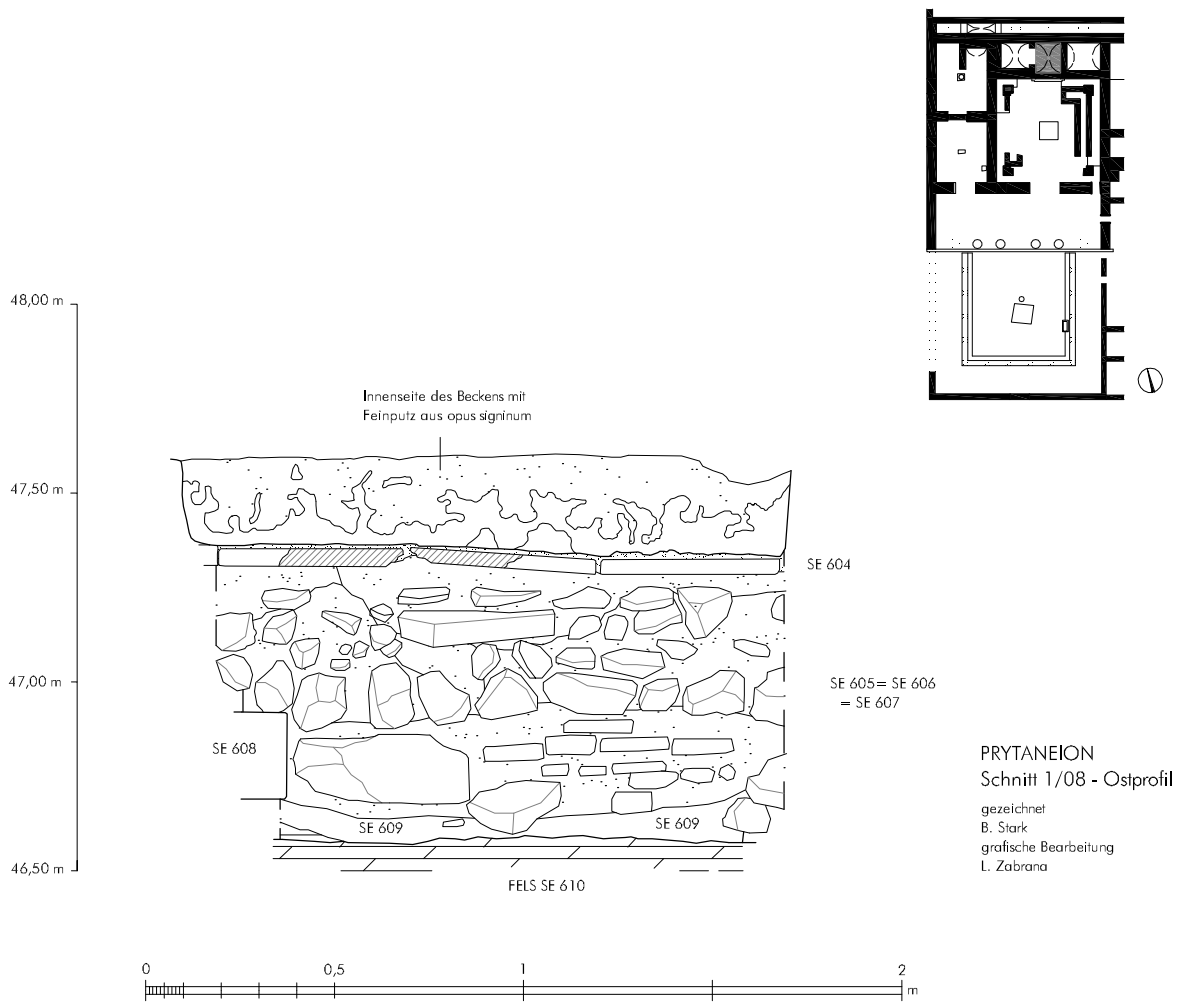

2 Schnitt 1/08. Westprofil (1:20)



1 Sekundäres Wasserreservoir in Raum 7 östlich des Prytaneions



2 Sekundäre Wasserentnahmestelle östlich von Raum 7

PRYTANEION
 BAUPHASE 1 Rekonstruktion

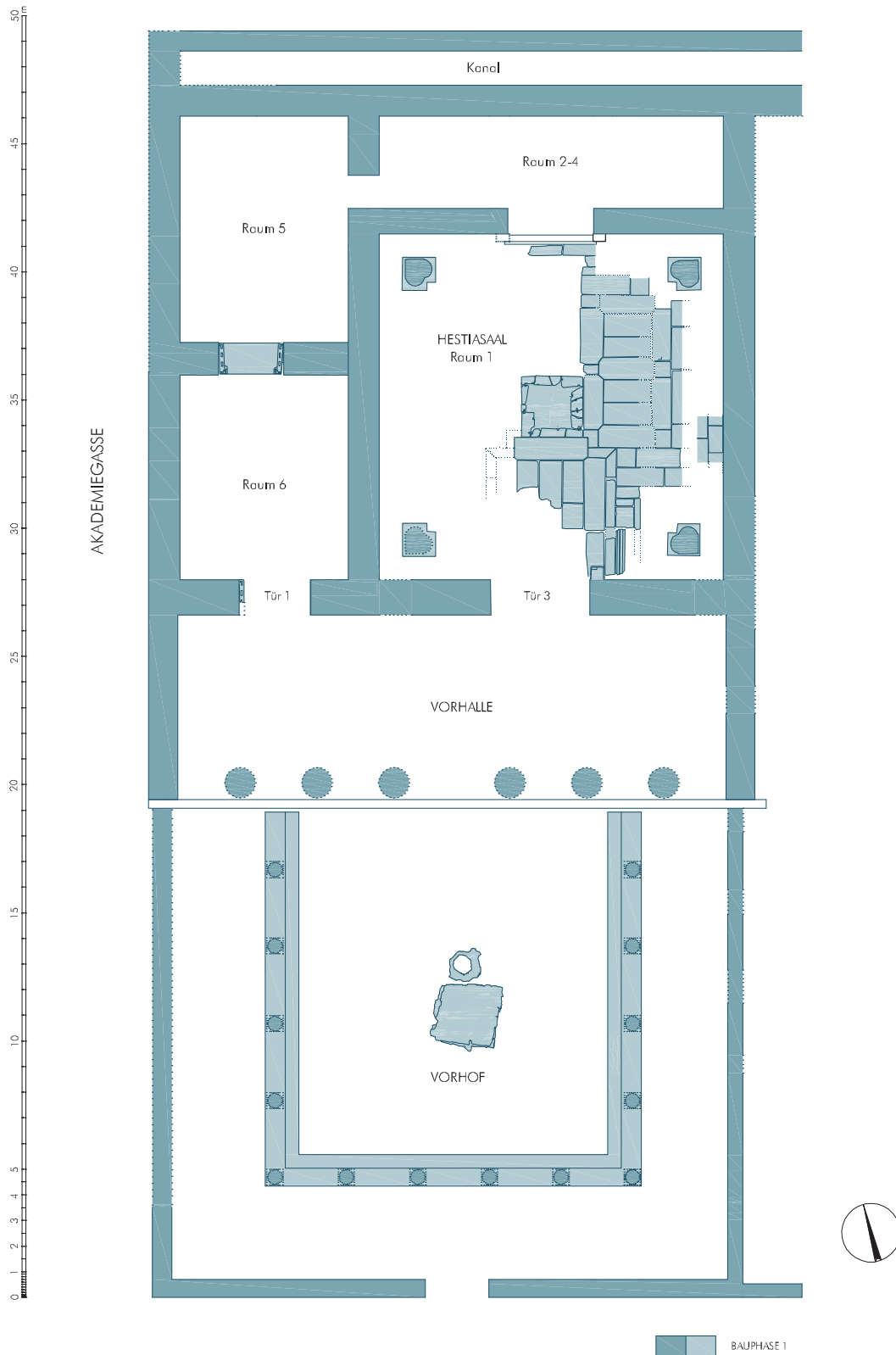

1 Prytaneion. Rekonstruierter Grundriss – Bauphase 1 (1:250). – Geschnittene Bauteile dunkel, aufsichtige Bauteile hell

PRYTANEION

BAUPHASE 2 Rekonstruktion

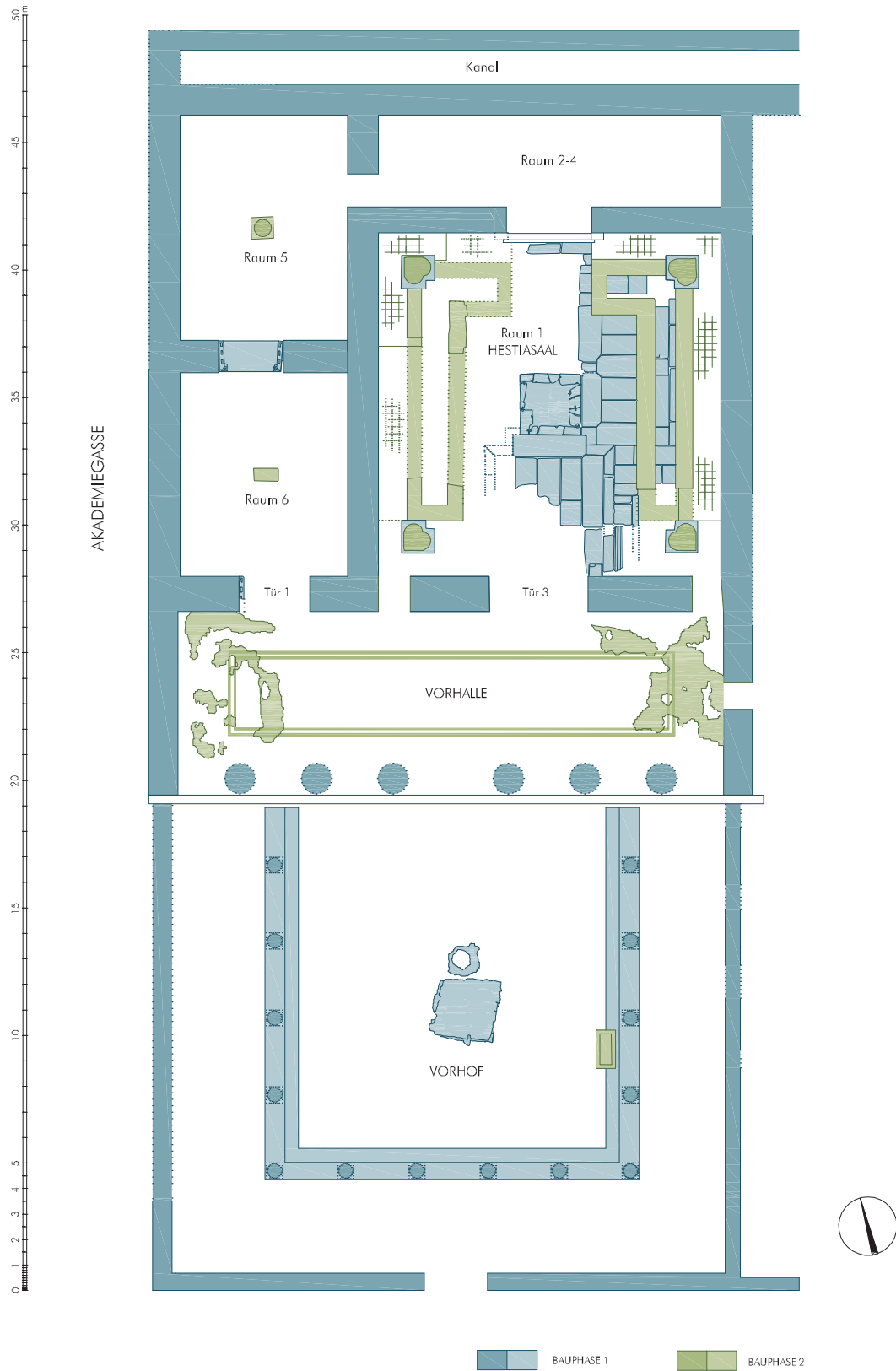

1 Prytaneion. Rekonstruierter Grundriss – Bauphase 2 (1:250). – Geschnittene Bauteile dunkel, aufsichtige Bauteile hell

PRYTANEION

BAUPHASE 3 Rekonstruktion

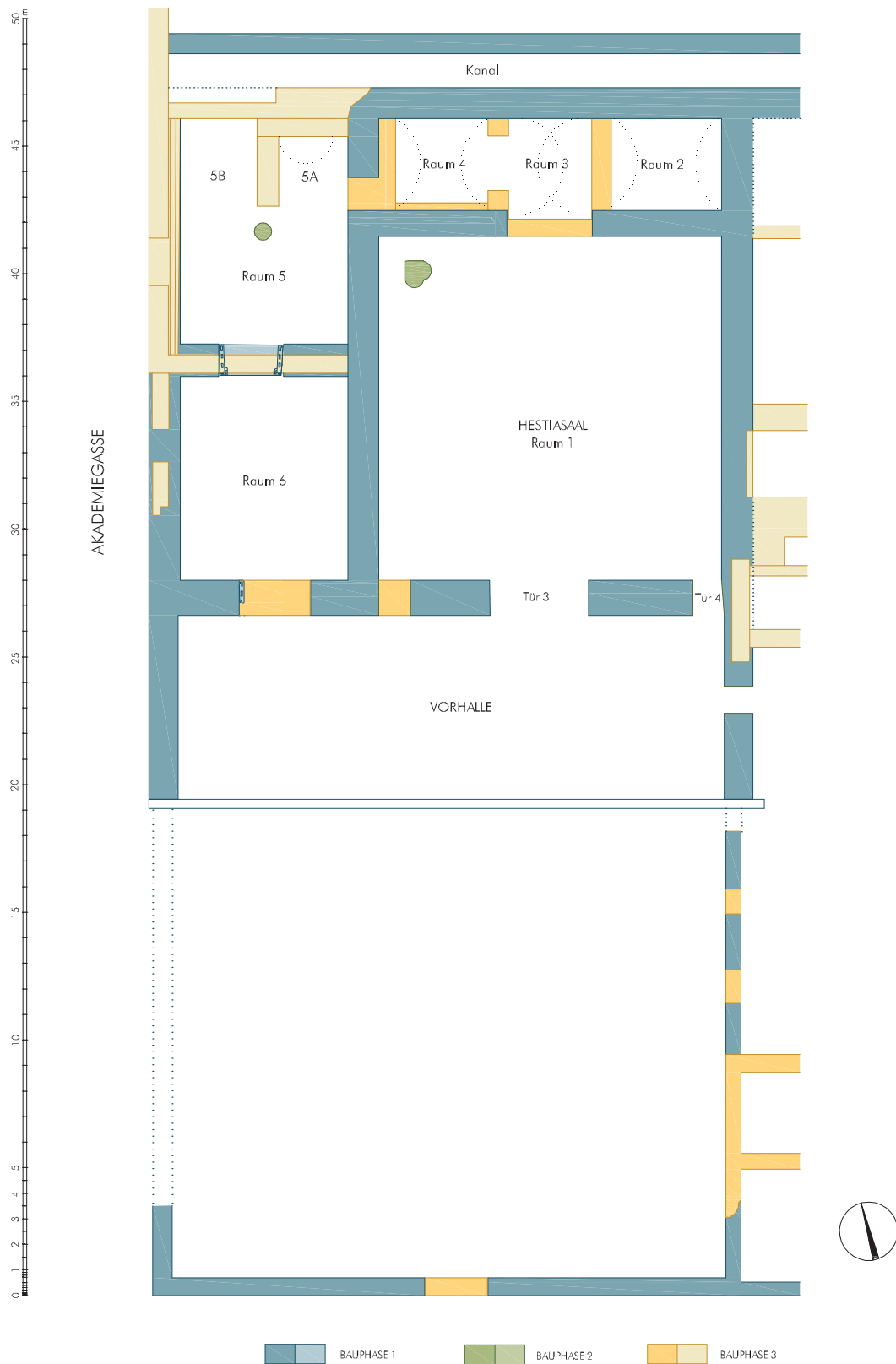

1 Prytaneion. Rekonstruierter Grundriss – Bauphase 3 (1:250). – Geschnittene Bauteile dunkel, aufsichtige Bauteile hell

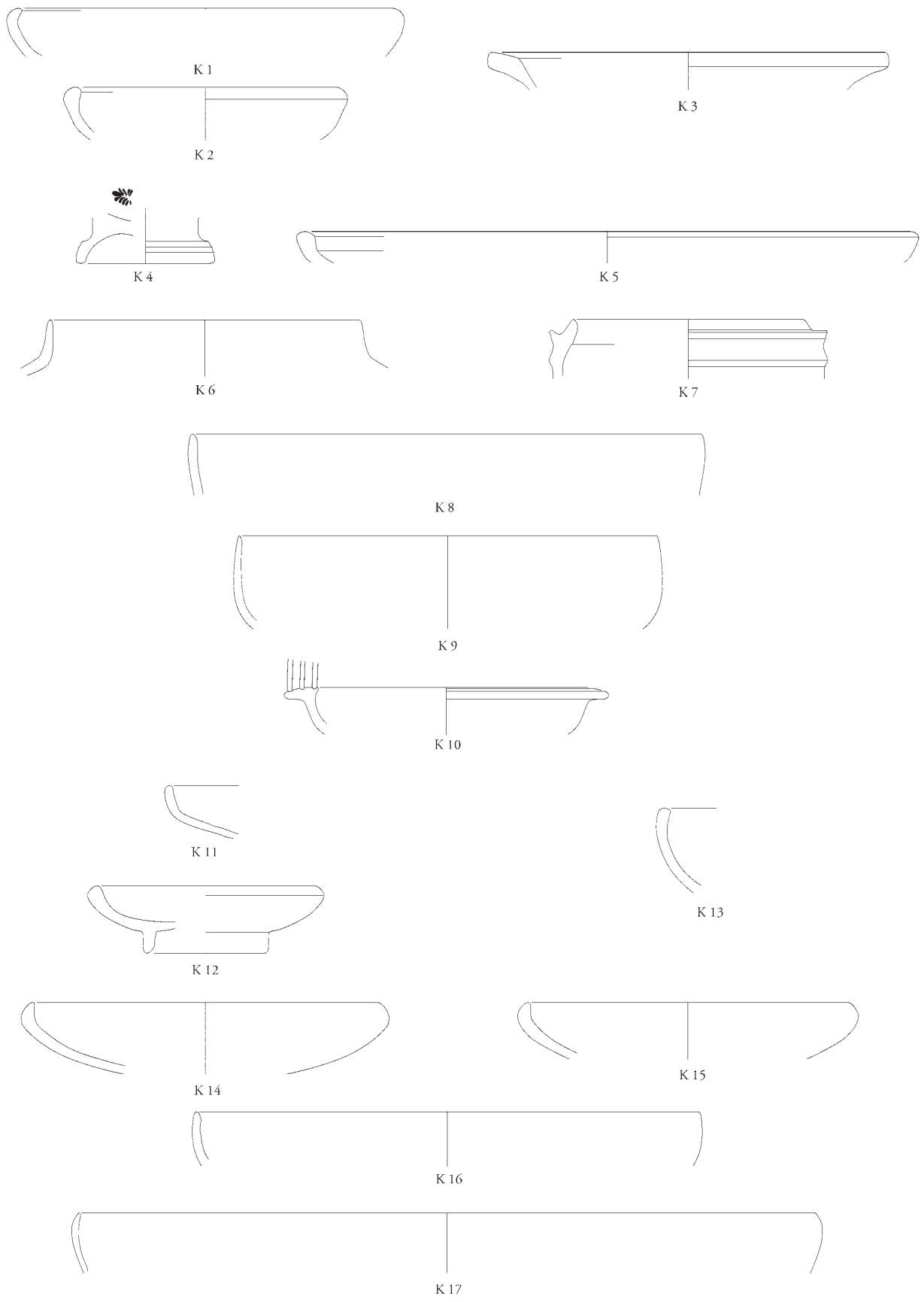

K 1-17

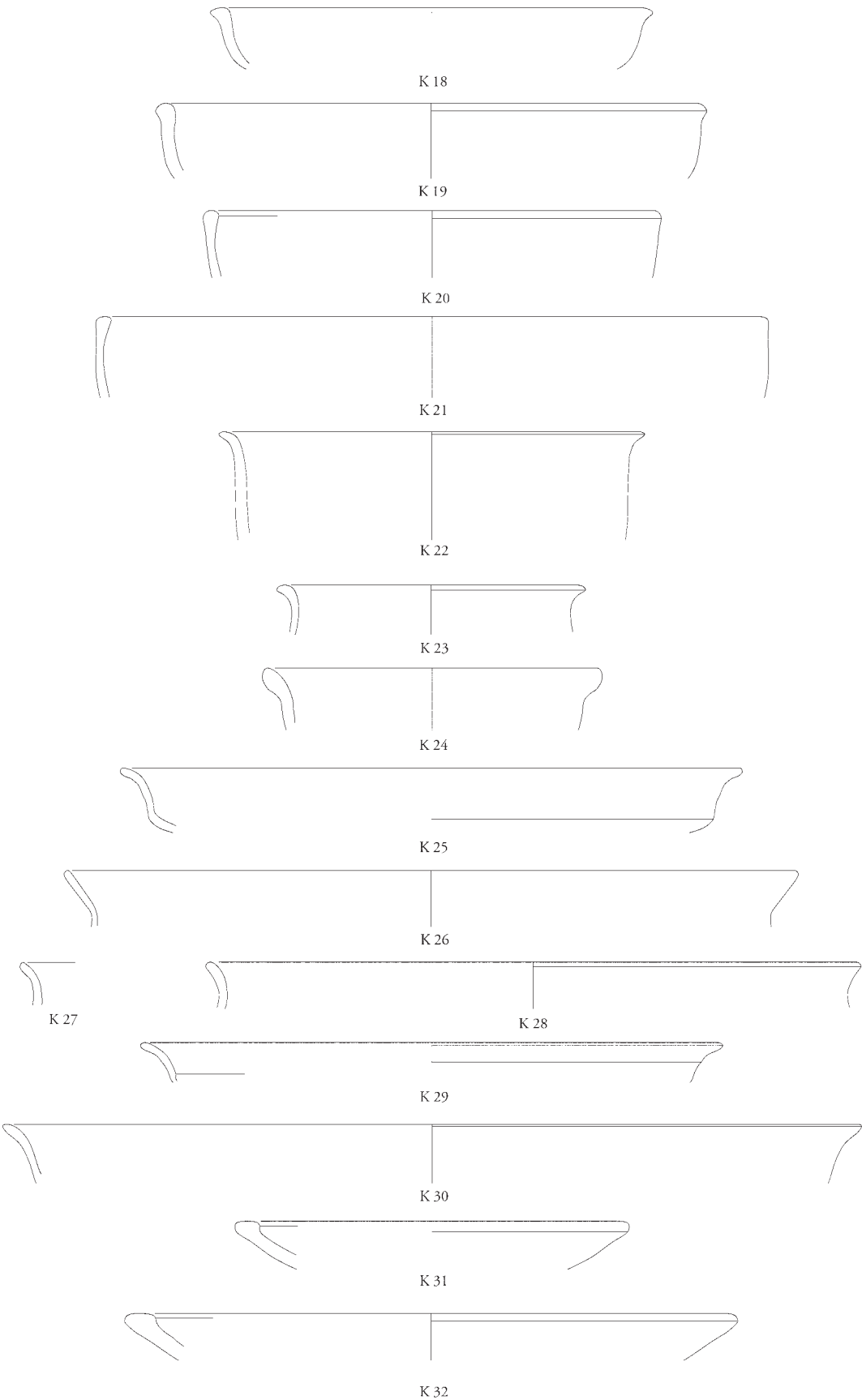

K 18-32

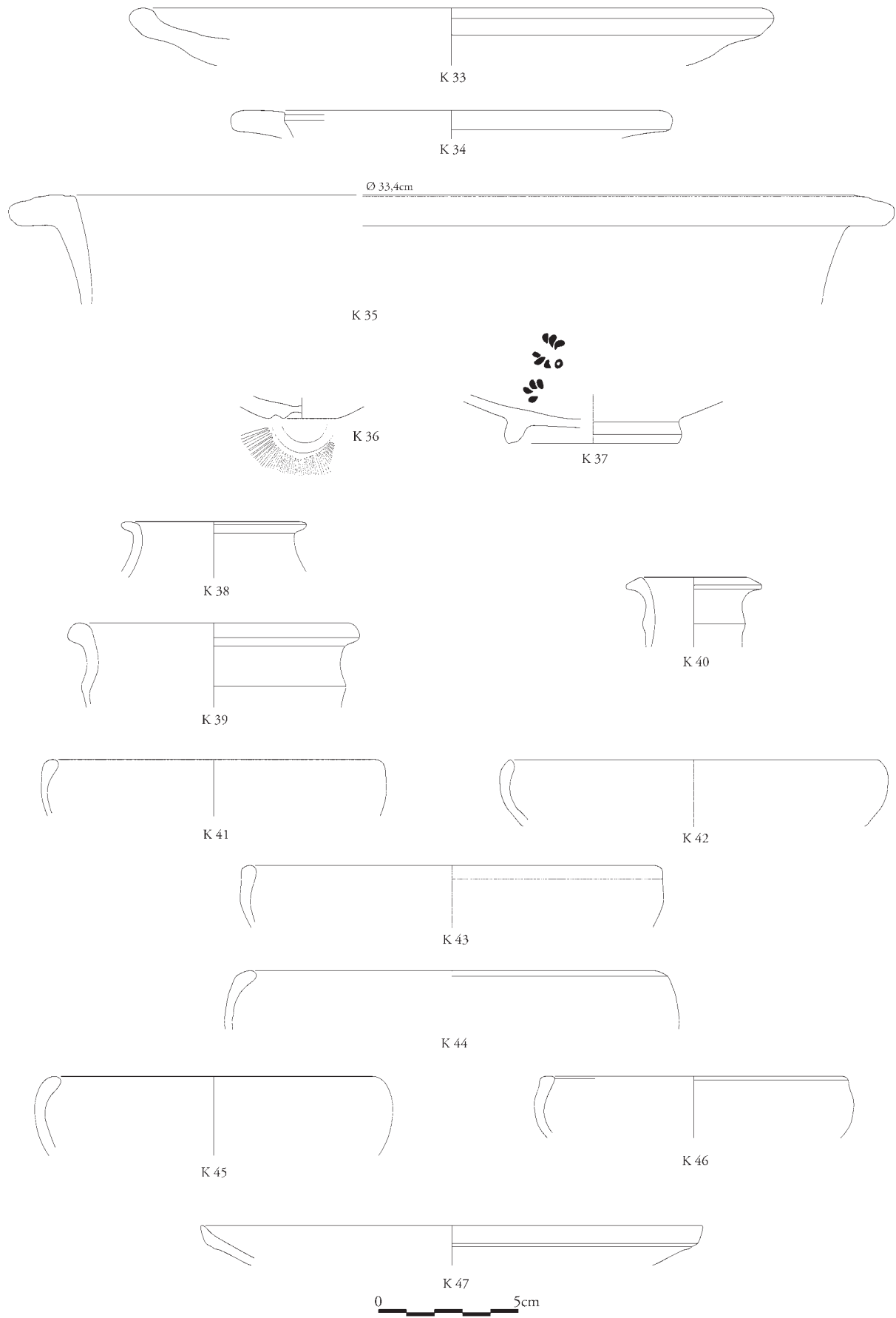

K 33-47

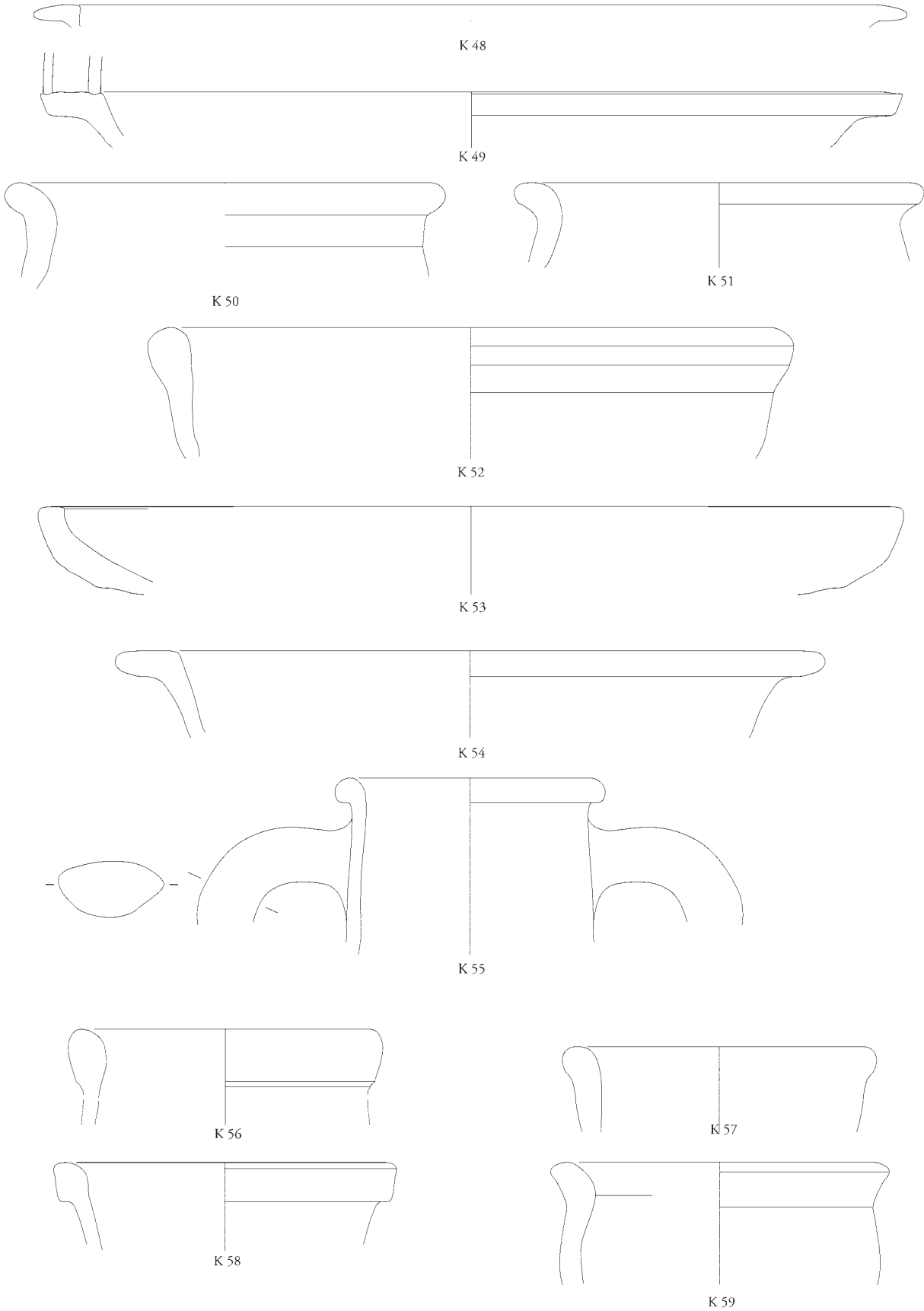

0 5cm

K 48-59

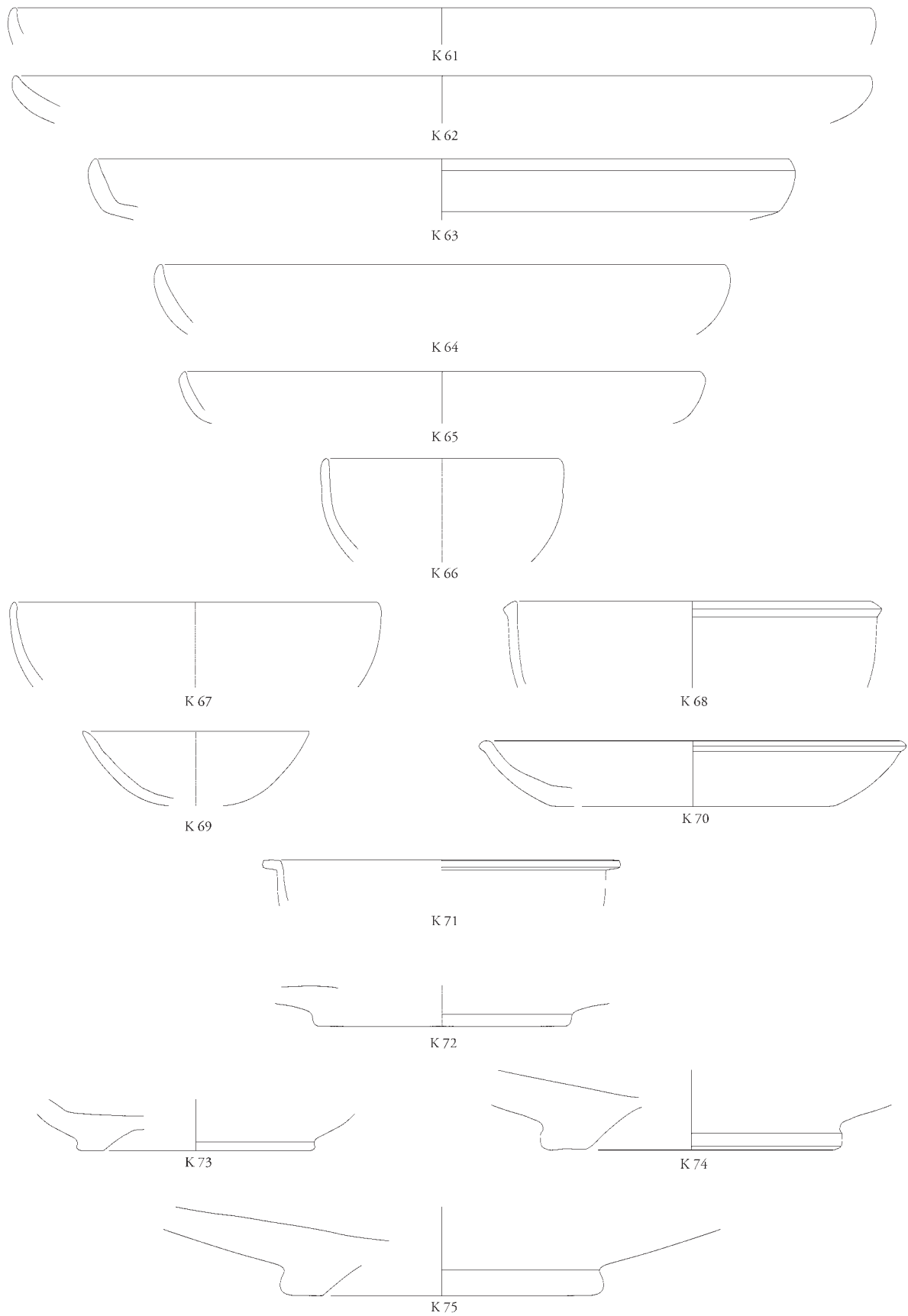

0 5cm

K 61-75

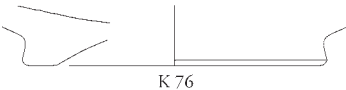

K 76

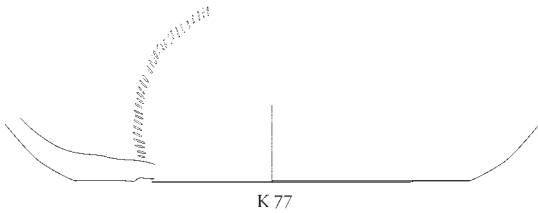

K 77

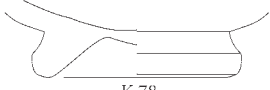

K 78



K 79



K 80



K 81

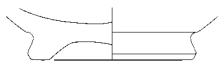

K 82

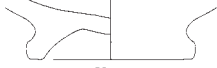

K 83



K 84

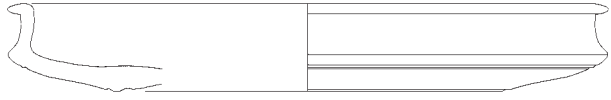

K 85



K 86

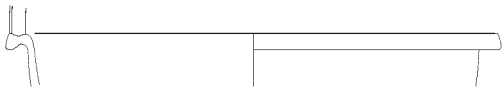

K 87



K 88

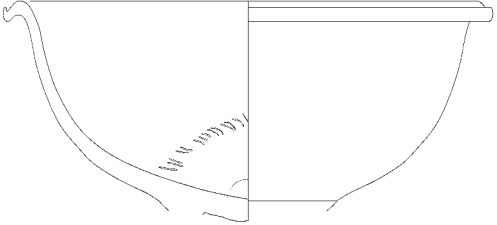

K 89



K 90

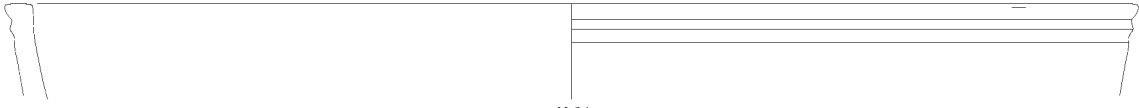

K 91

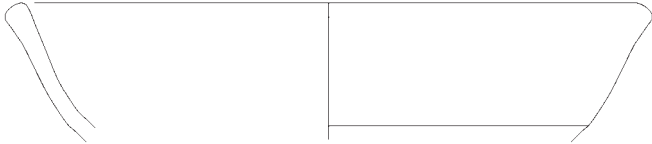

K 92



K 93



K 76-93

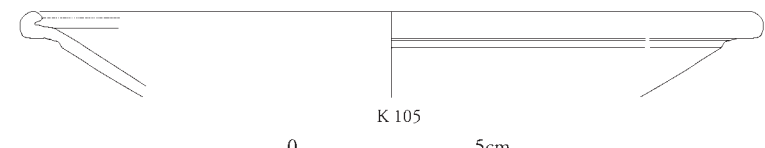
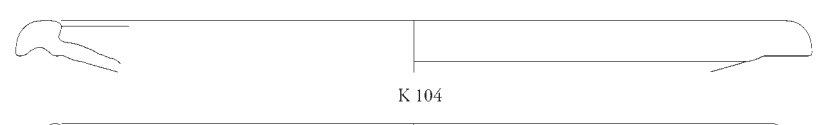
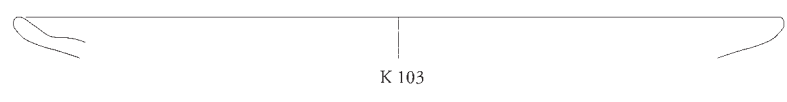
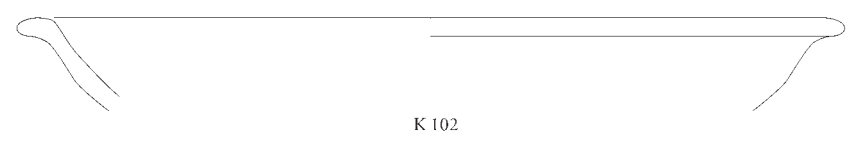
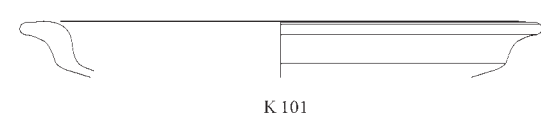
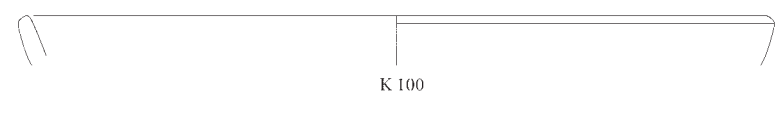
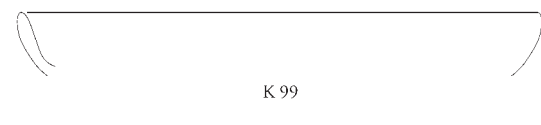
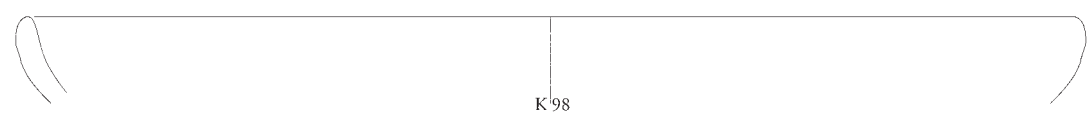
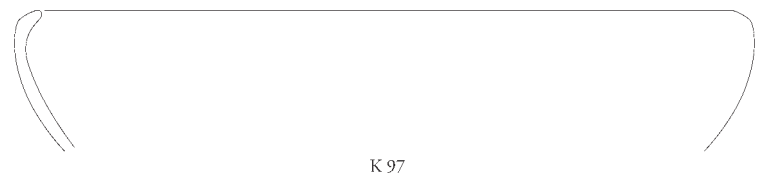
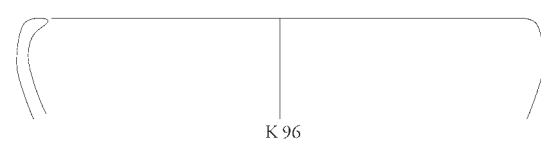
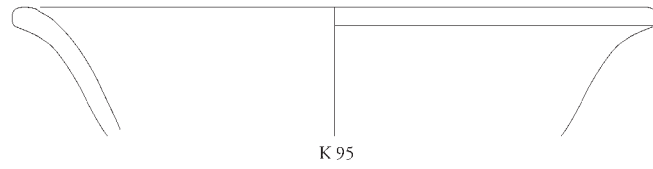
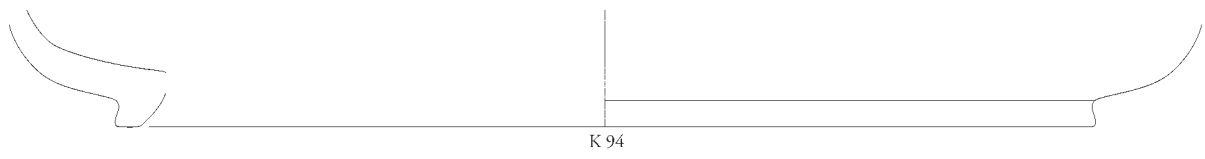

K 94-105

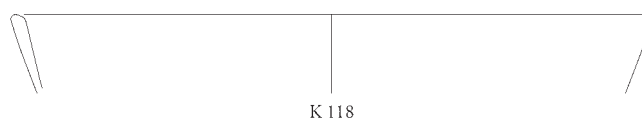
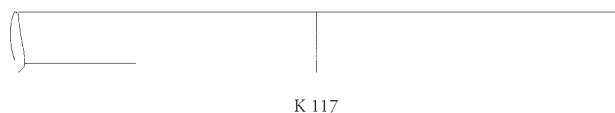
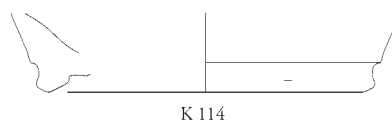
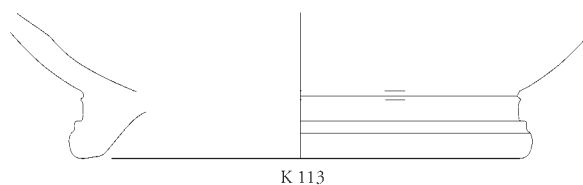
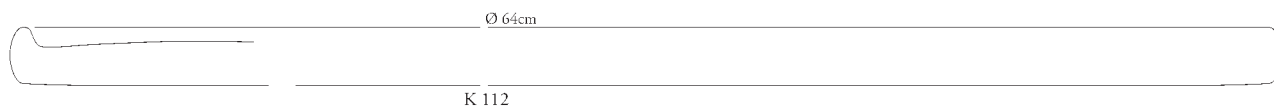
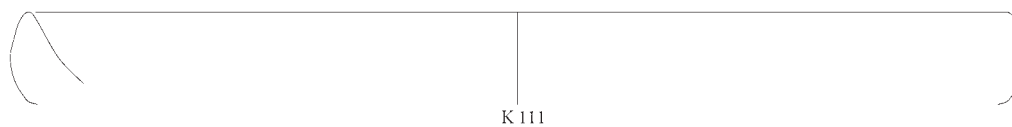
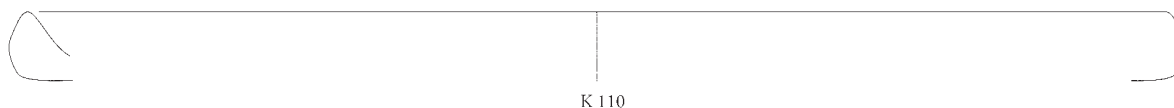
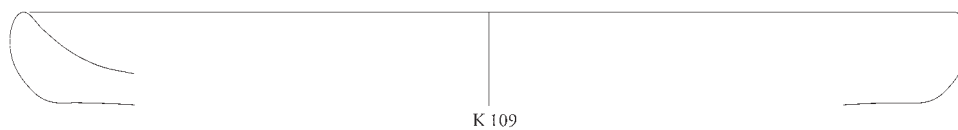
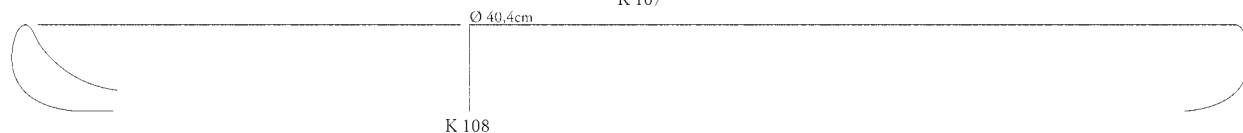
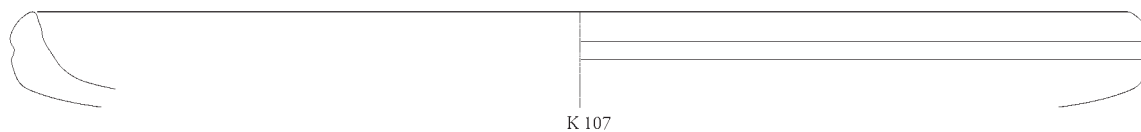

K 106-114. 117-118

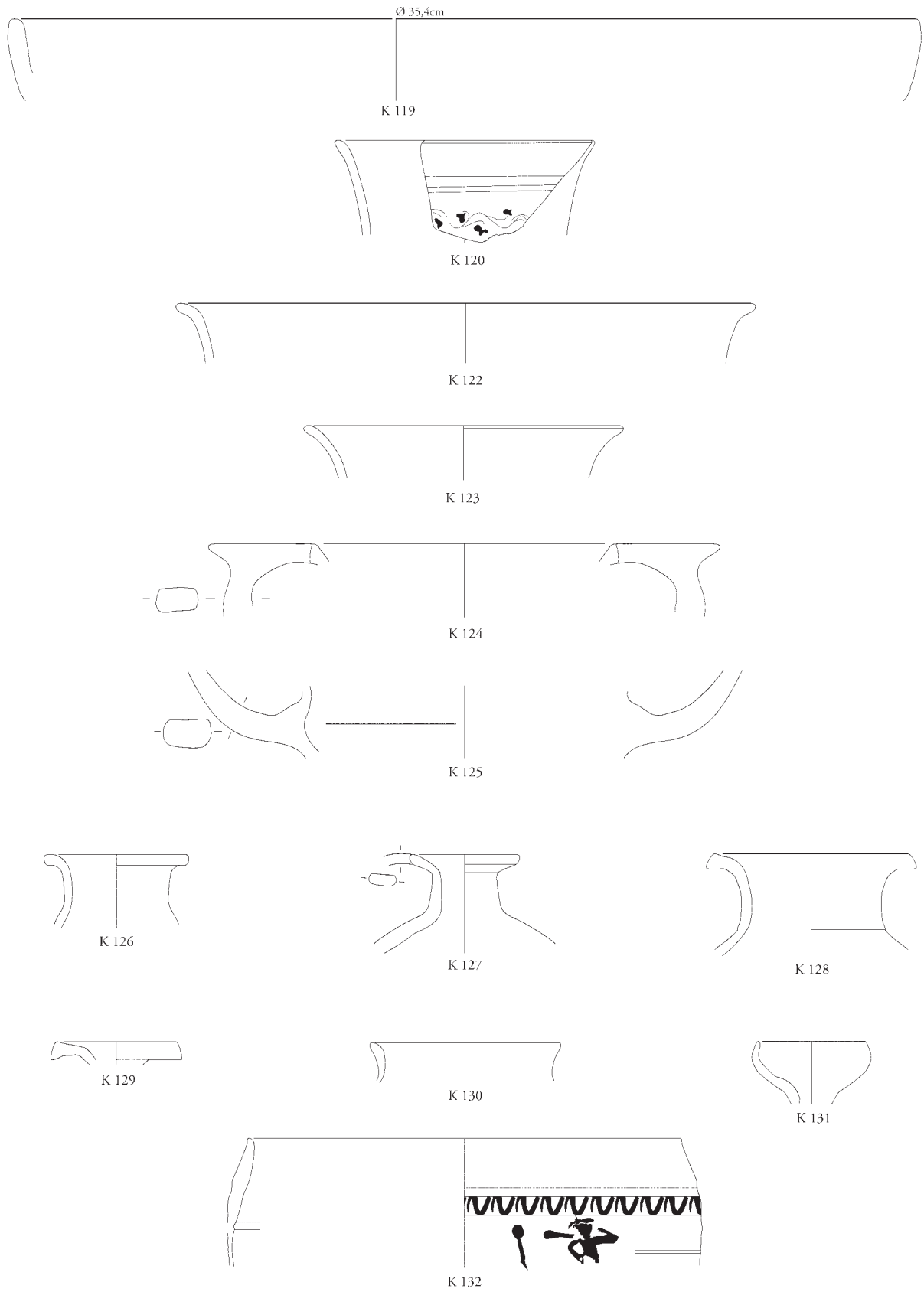



K 133



K 134



K 135

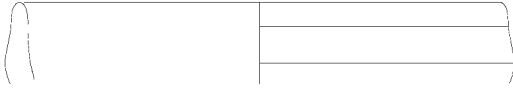

K 136

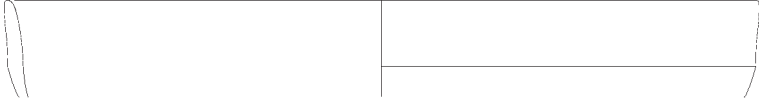

K 137



K 138

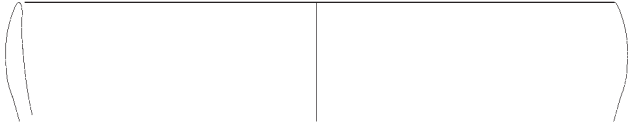

K 151



K 152



K 153



K 154



K 155



K 133-138. 151-155

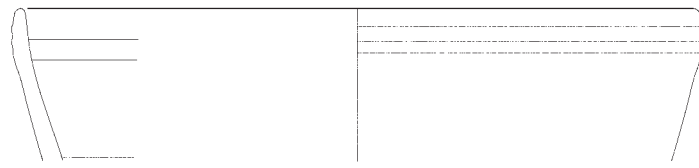

K 156

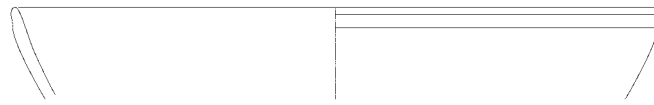

K 157



K 158

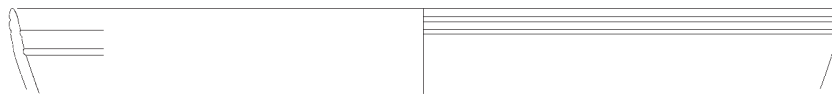

K 159

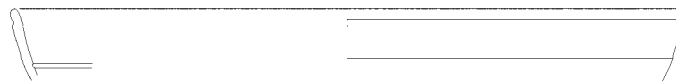

K 160

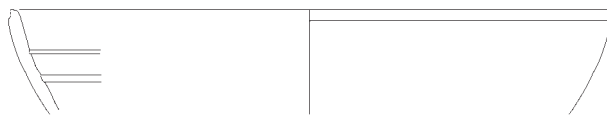

K 161



K 162

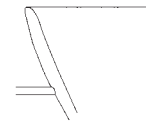

K 163

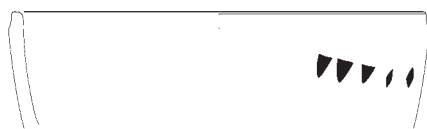

K 167

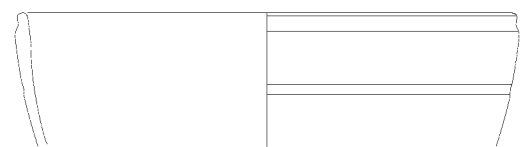

K 168

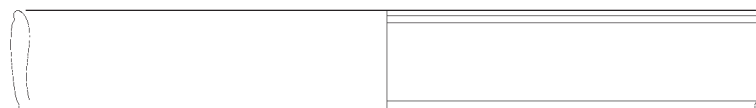

K 169

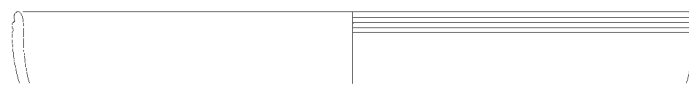

K 170





K 171



K 172



K 173

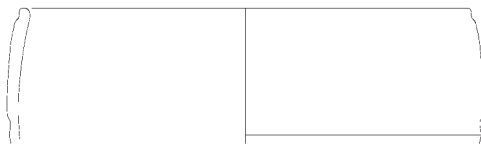

K 174



K 175



K 176



K 177



K 178

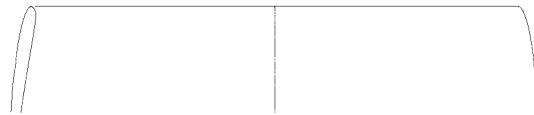

K 179

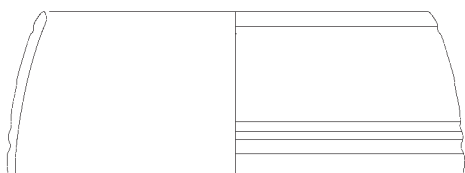

K 180



K 181

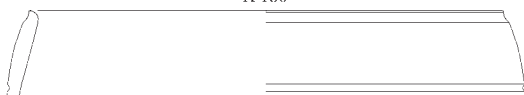

K 182



K 183



K 184



K 171-184

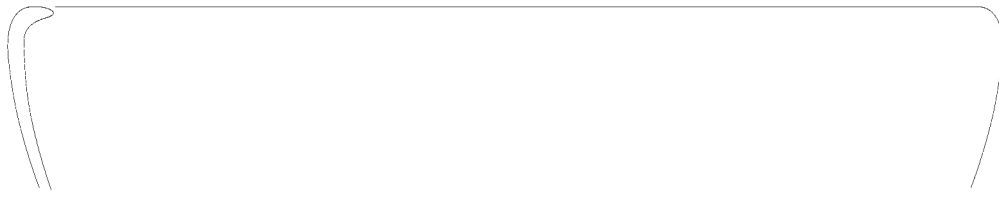

K 185



K 186



K 187



K 188



K 190

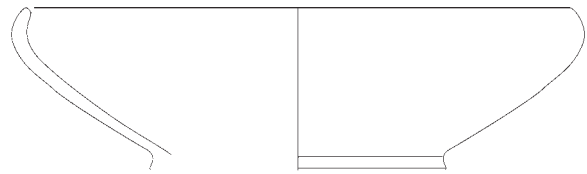

K 189



K 191

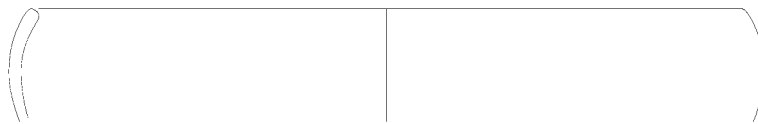

K 192



K 193



K 194



K 196

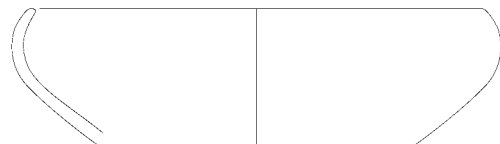

K 195



K 185-196

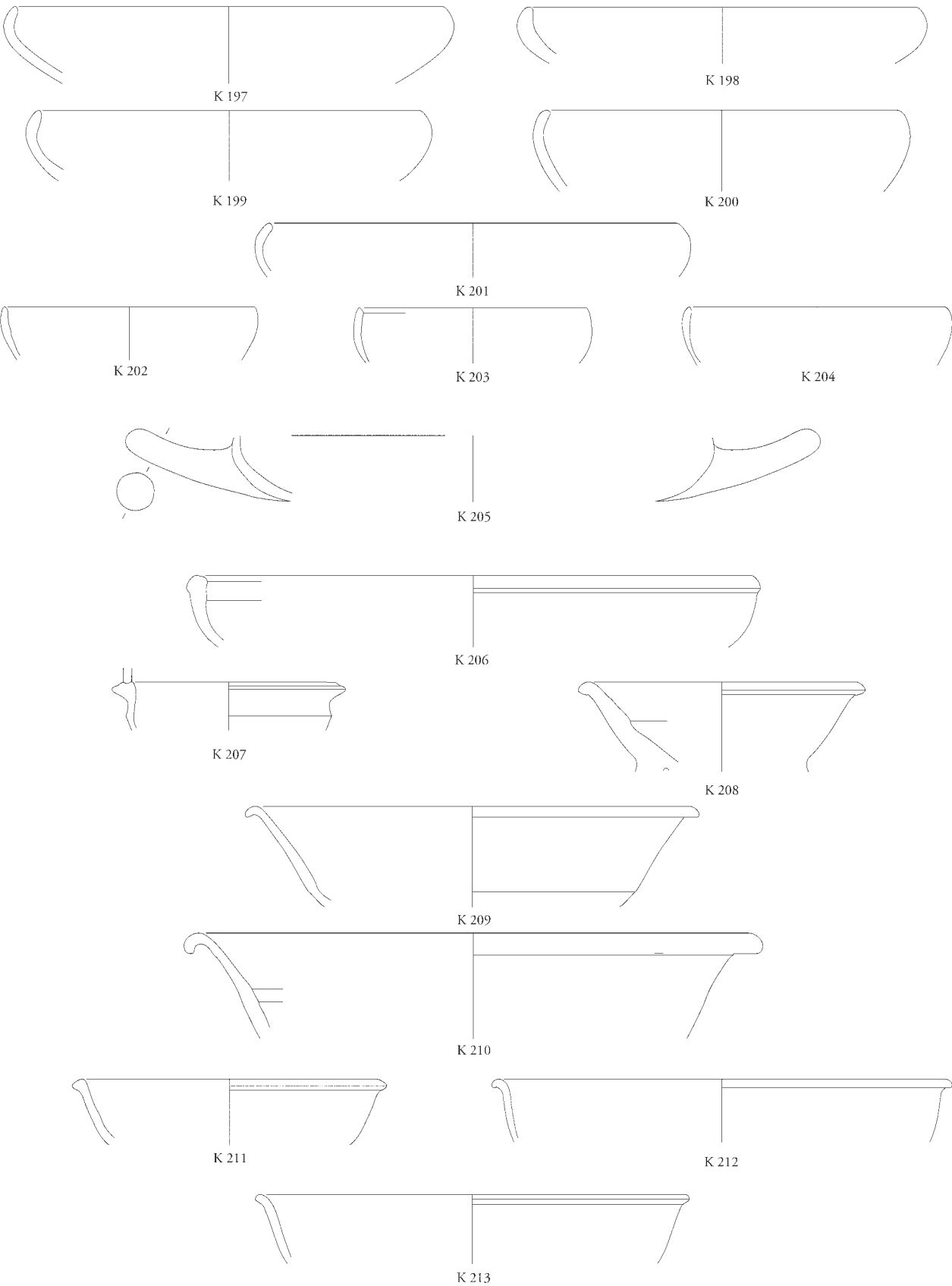

0 5cm

K 197-213

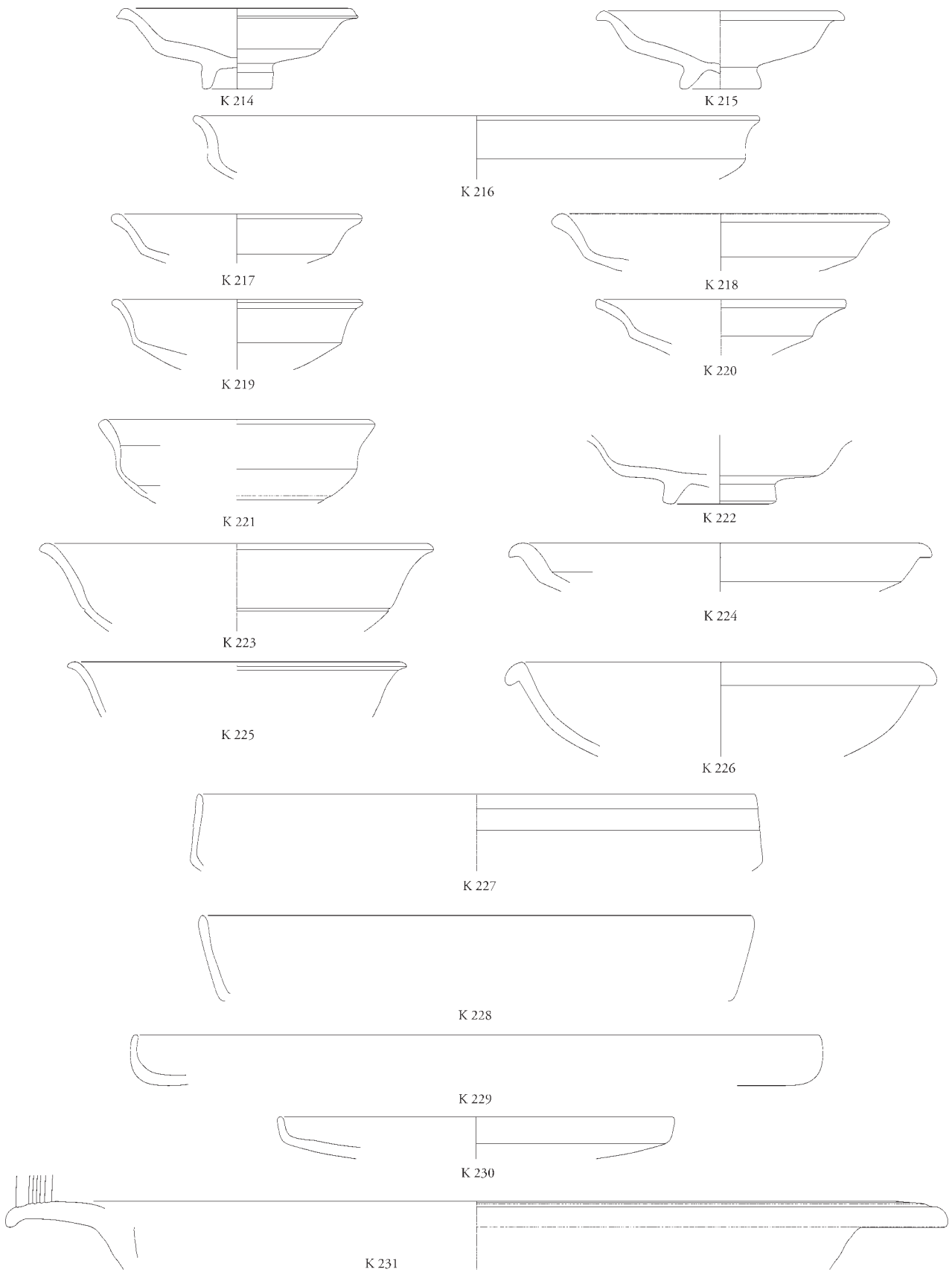

K 214-231

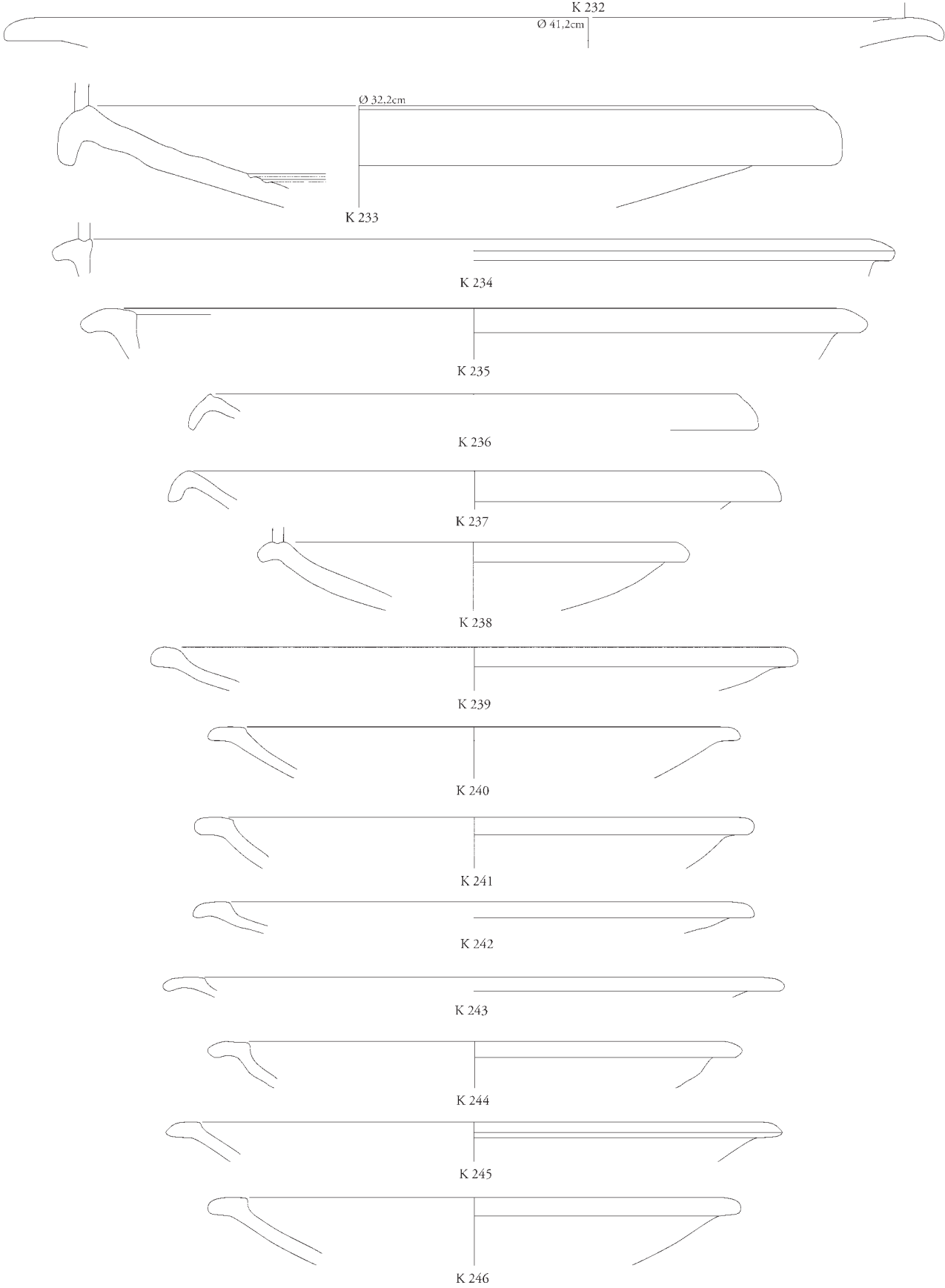

K 232-246

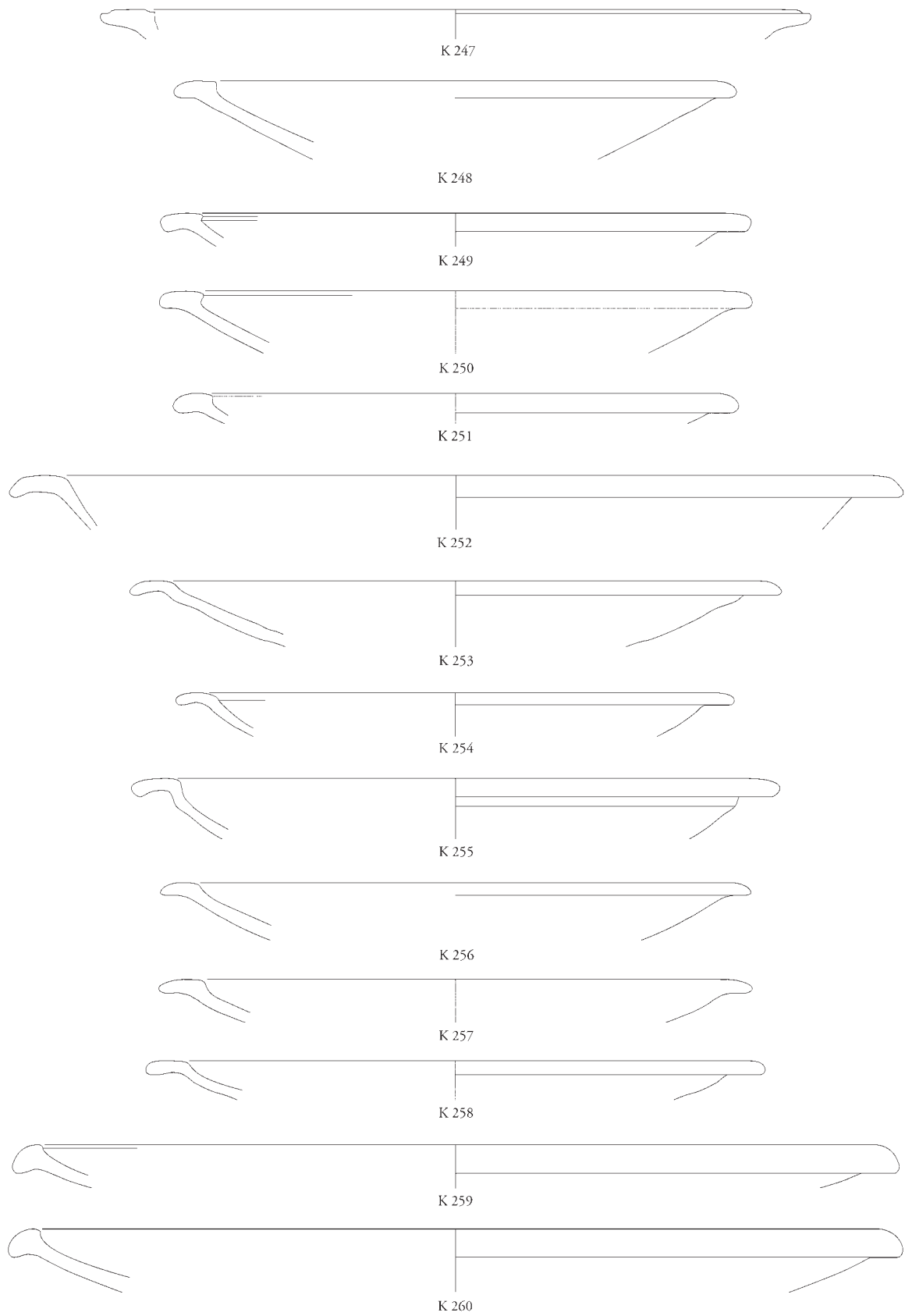

0 5cm

K 247-260

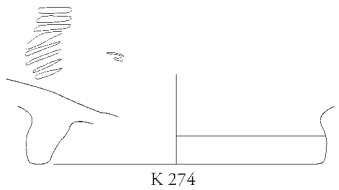
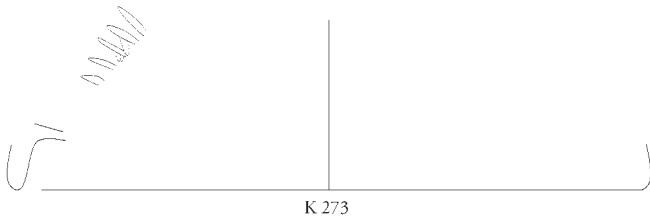
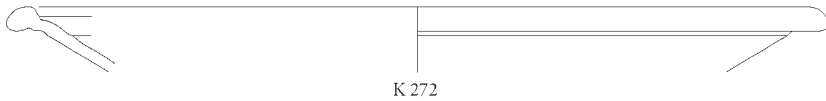
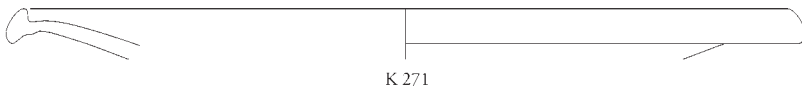
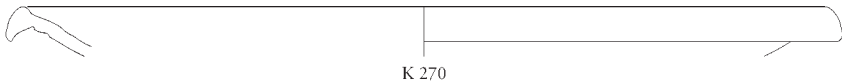
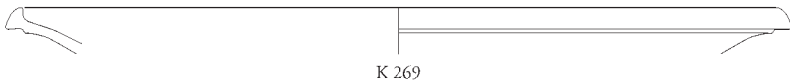
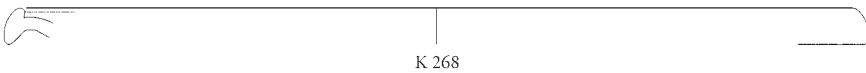
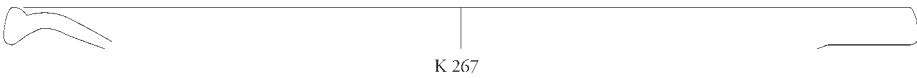
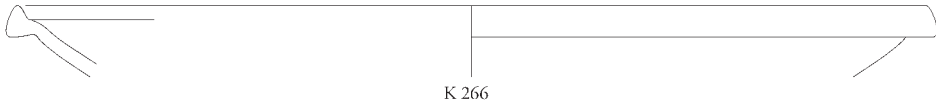
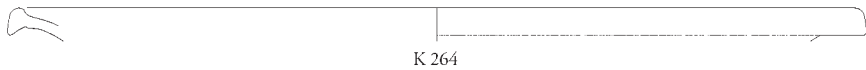
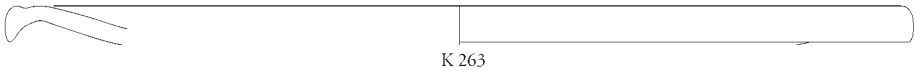
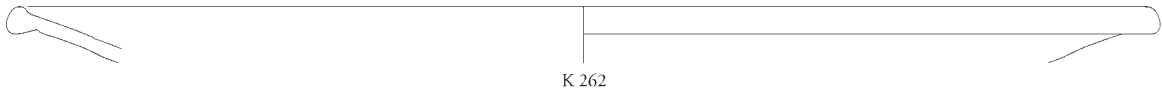
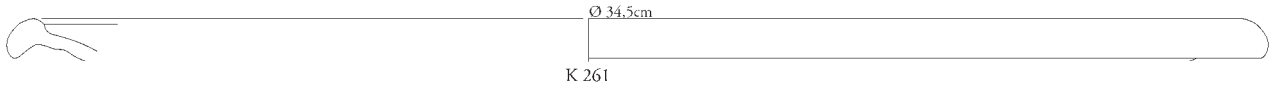

K 261-275

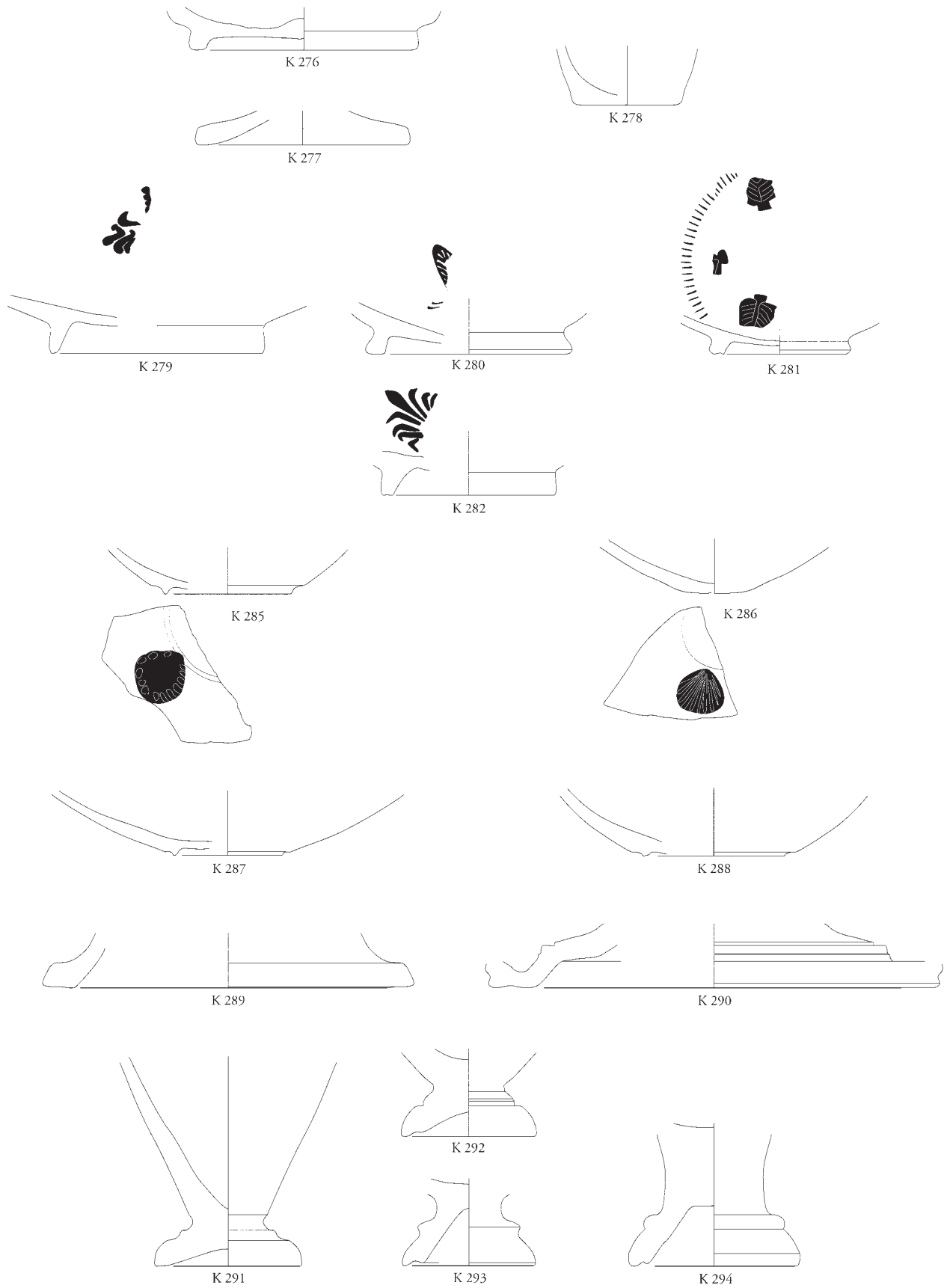

K 276–282. 285–294

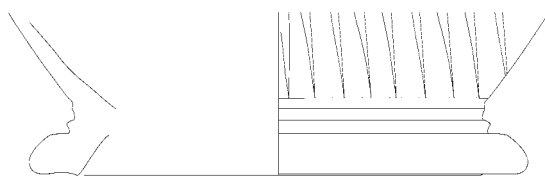

K 295

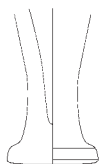

K 296

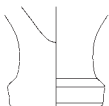

K 297



K 298

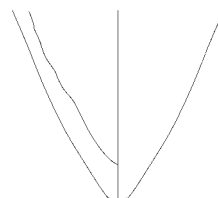

K 299

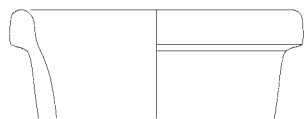

K 300

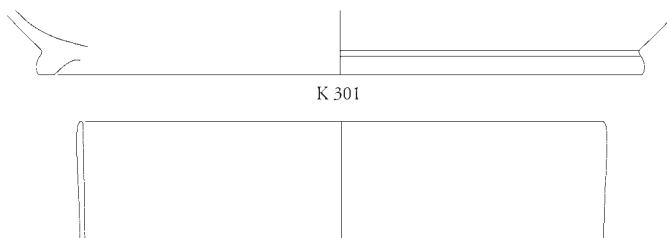

K 301



K 304



K 305



K 306



K 307



K 308



K 309



K 310



K 313

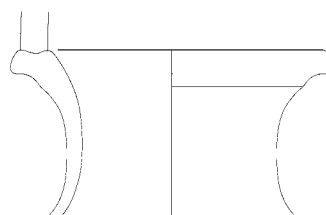

K 314



K 315

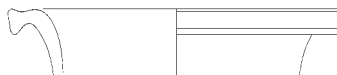

K 316

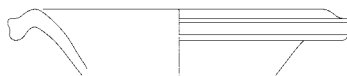

K 317

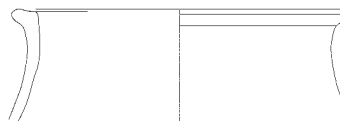

K 318



K 295-301. 304-310. 313-318

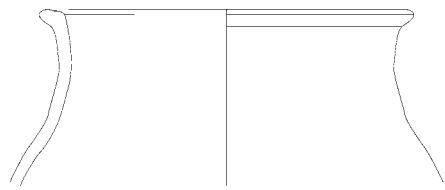

K 319

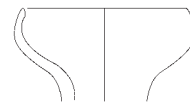

K 320

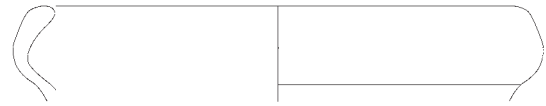

K 321

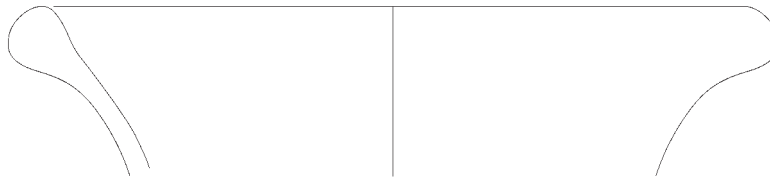

K 322

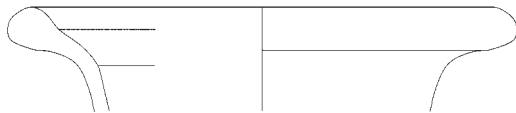

K 323



K 324



K 325

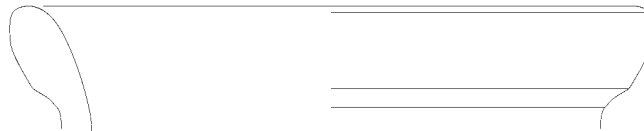

K 326



K 327

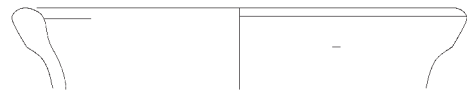

K 328



K 329

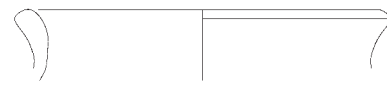

K 330



K 331

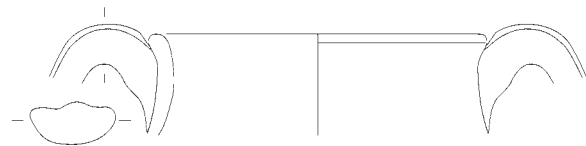

K 332



K 333

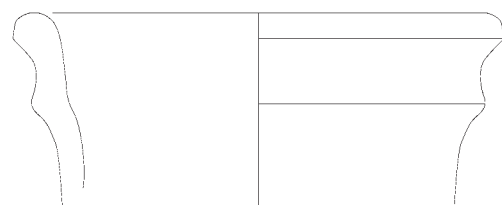

K 335



K 334



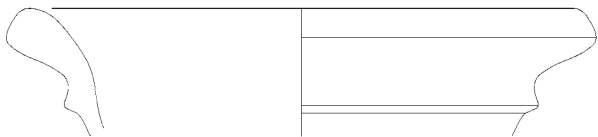

K 336

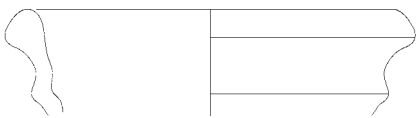

K 337

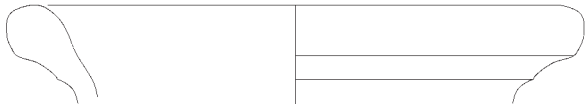

K 338

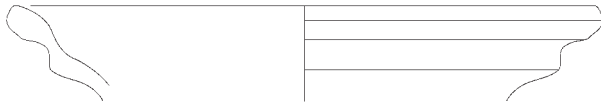

K 339



K 340

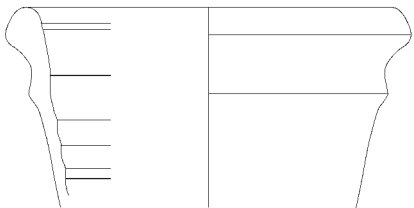

K 341

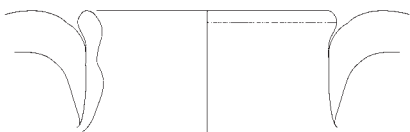

K 342

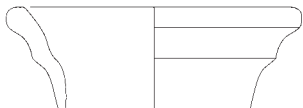

K 343



K 344

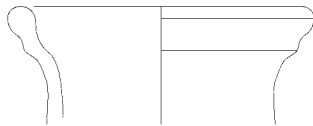

K 345

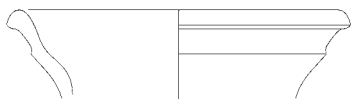

K 346

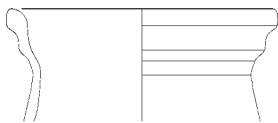

K 347

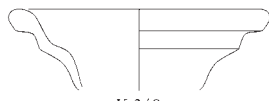

K 348



K 349

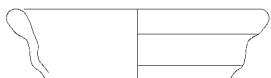

K 350



K 351

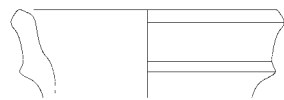

K 352

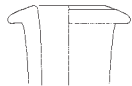

K 353



K 354

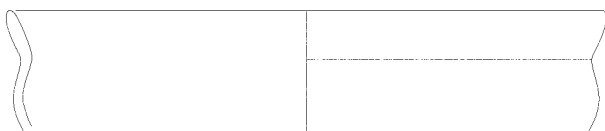

K 355

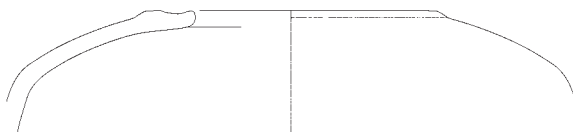

K 356



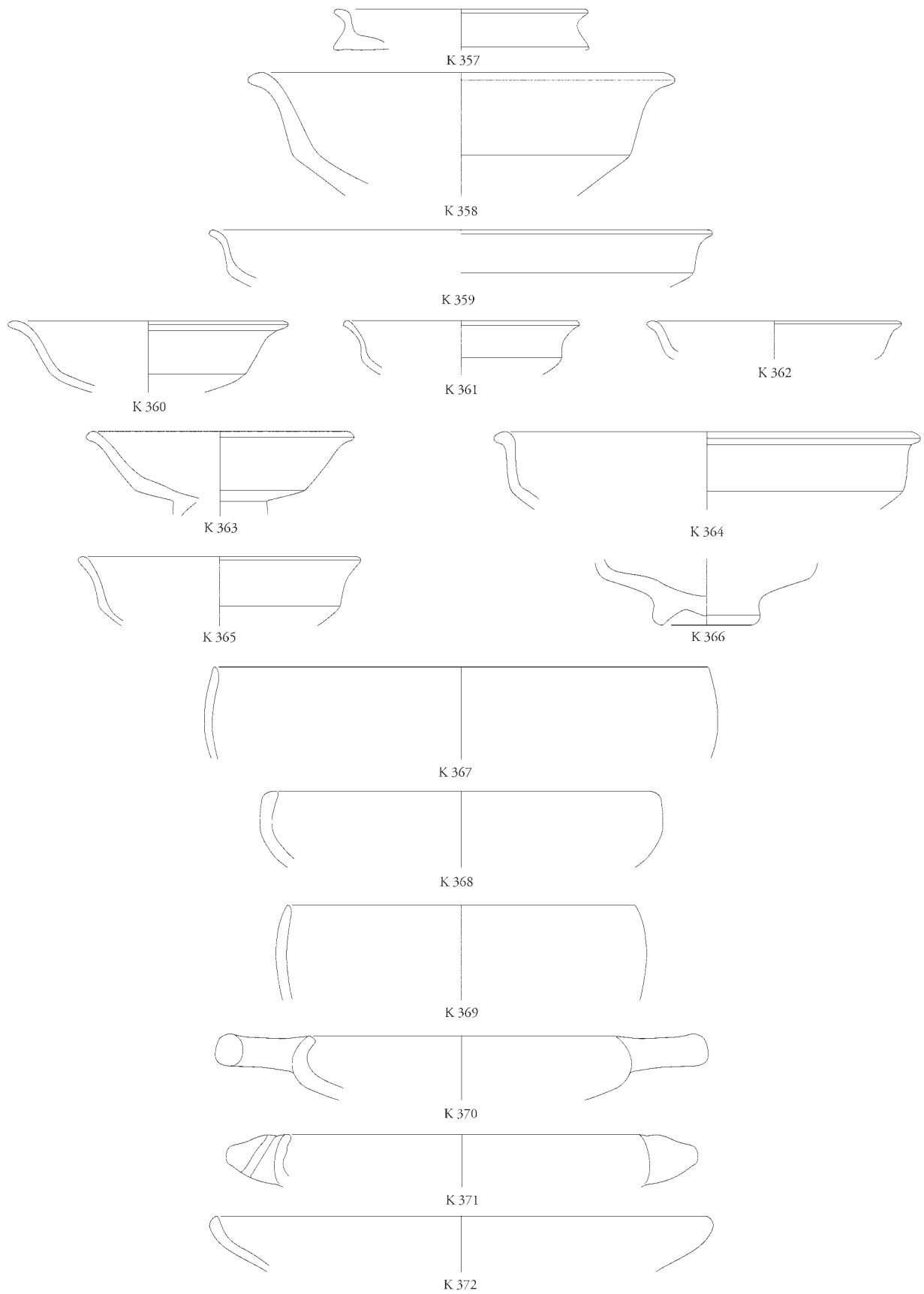

0 5cm

K 357-372

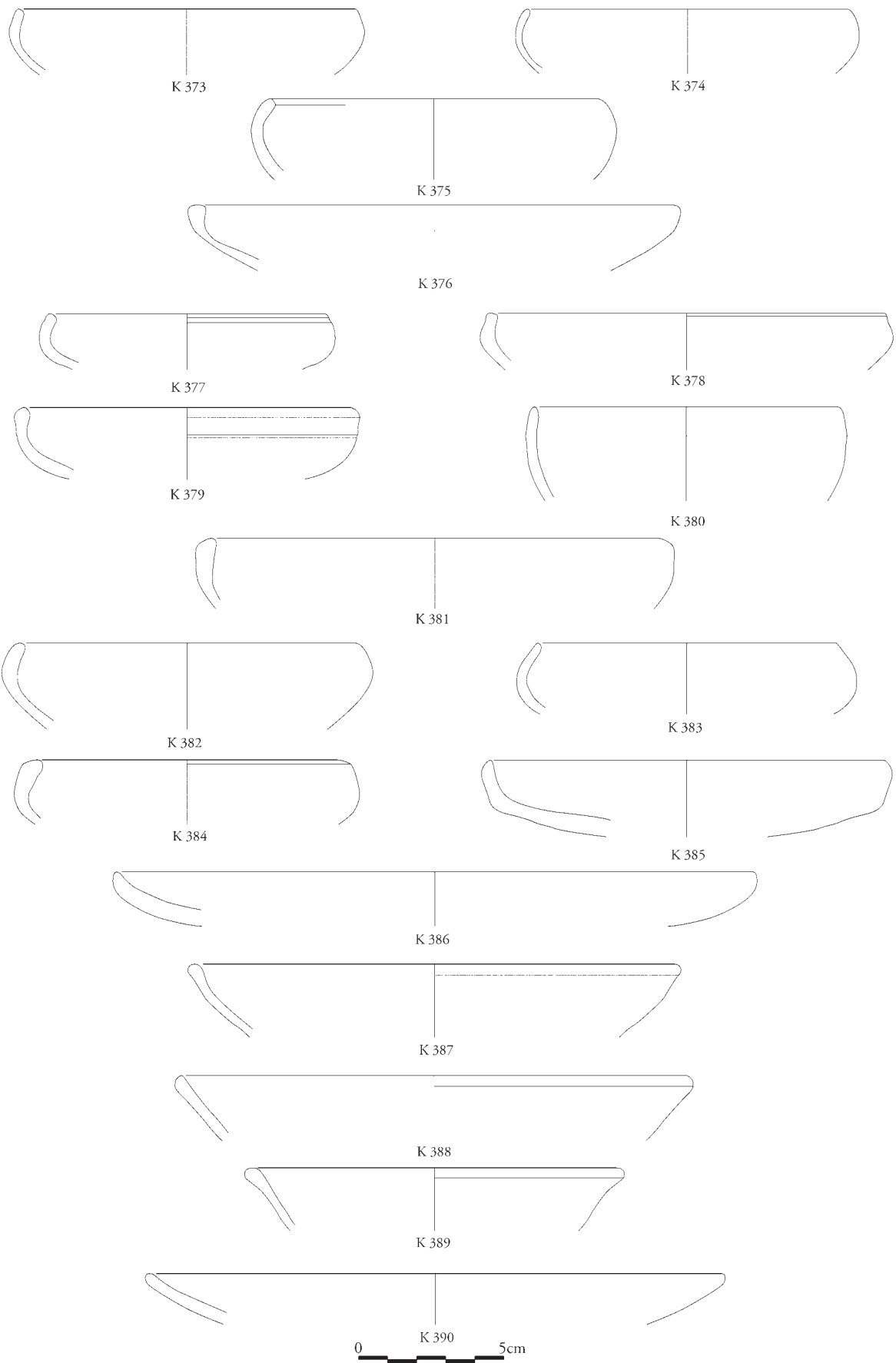

K 373–390

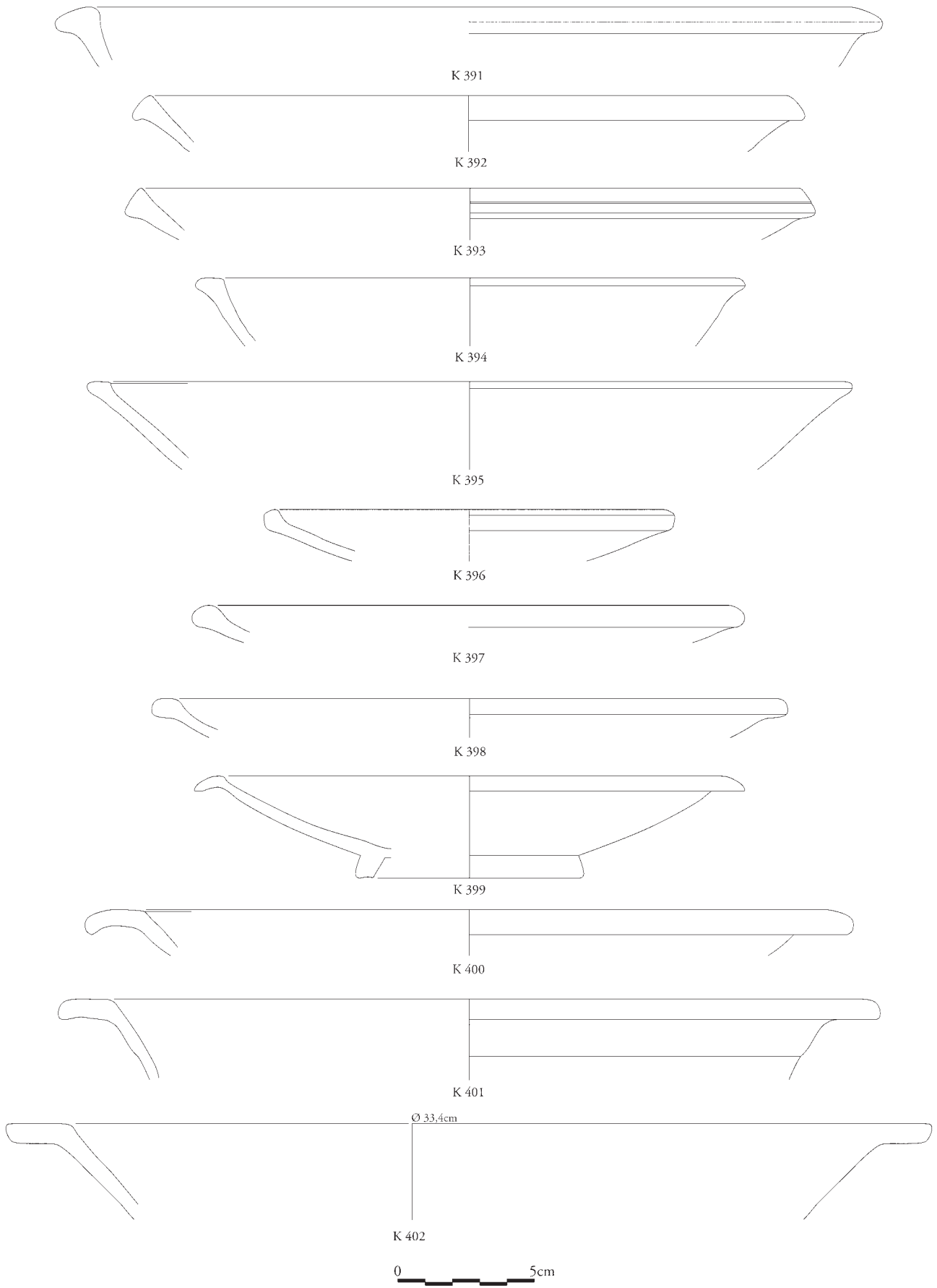

K 391-402

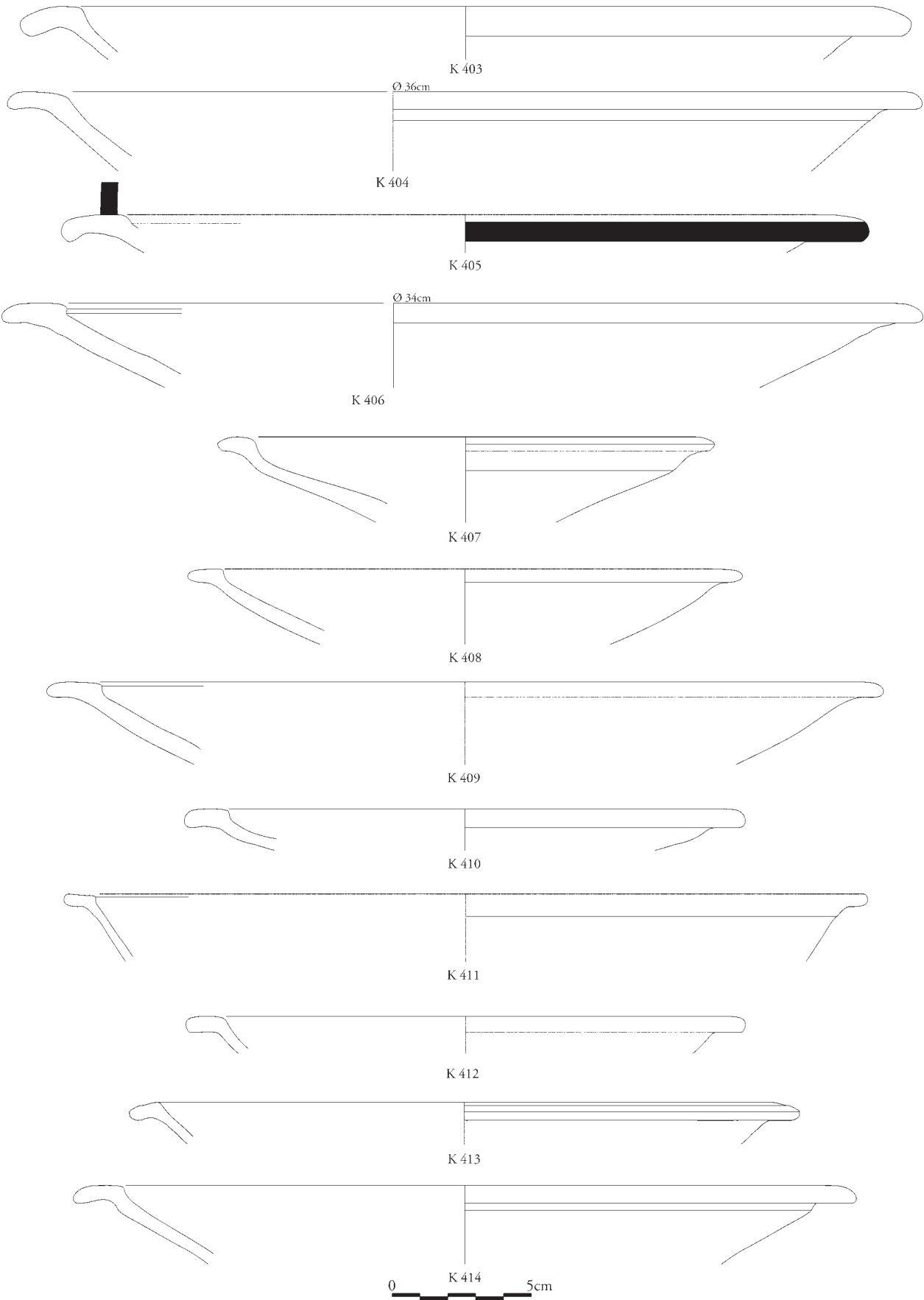

K 403-414

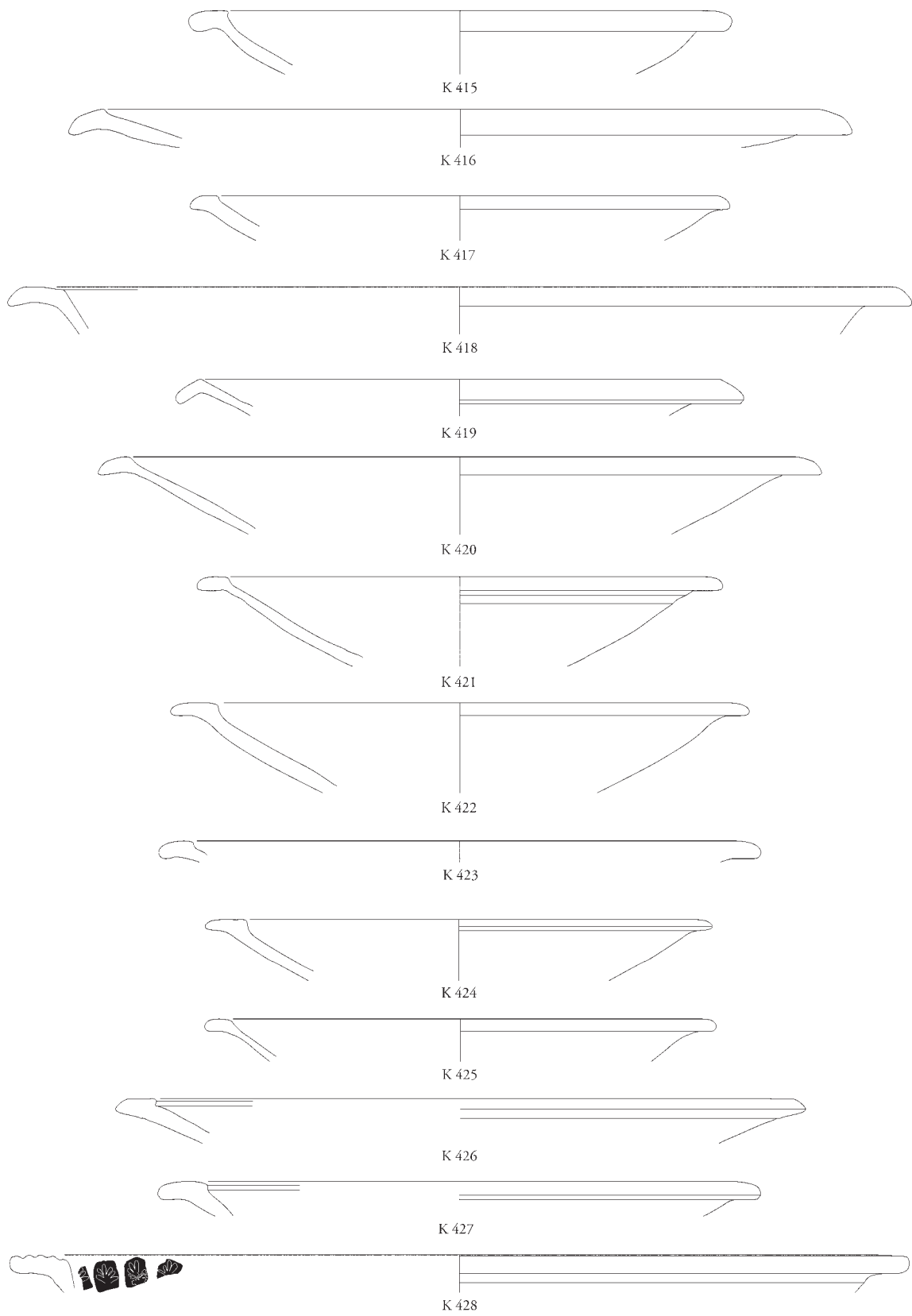

0 5cm

K 415-428

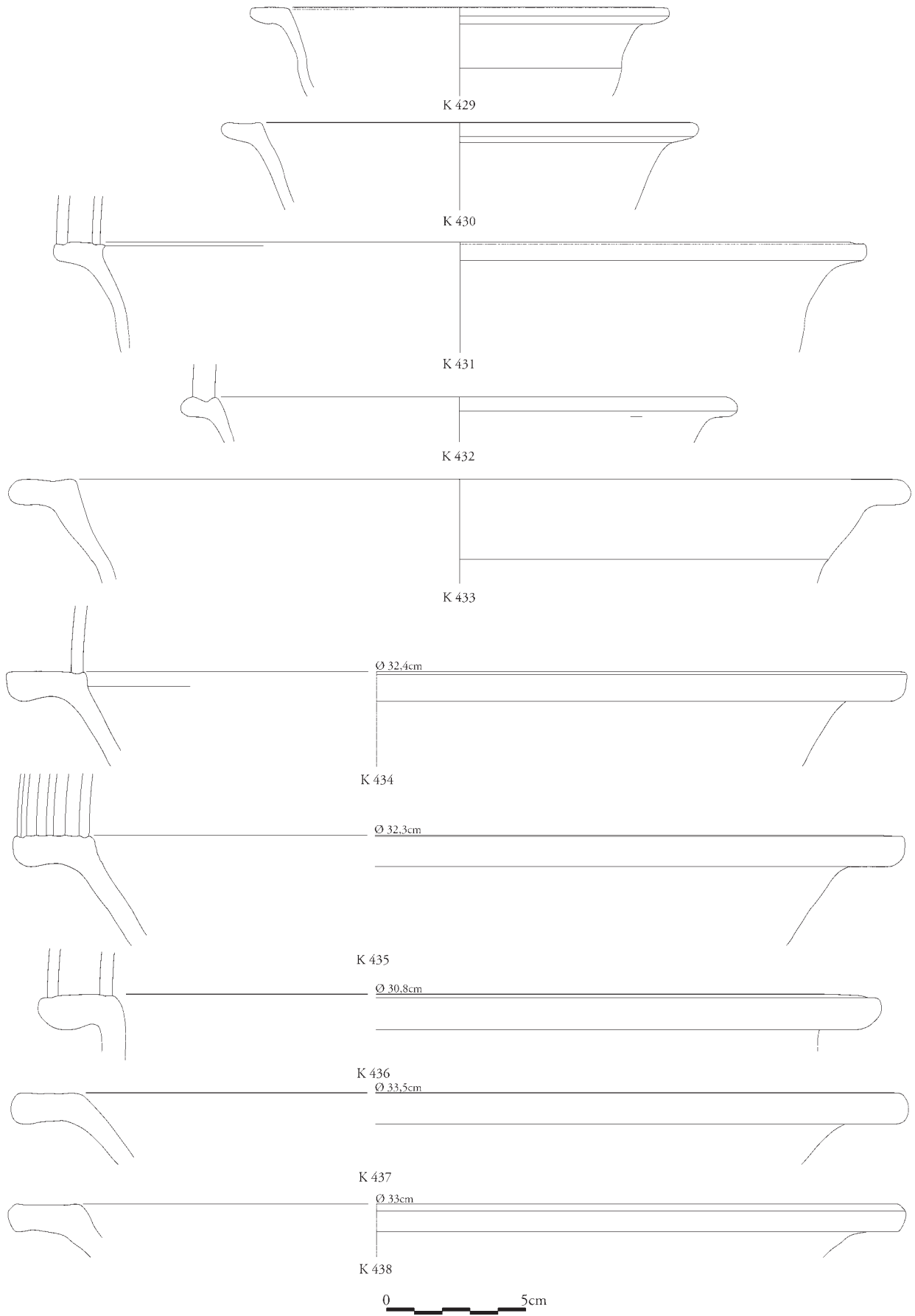

K 429–438

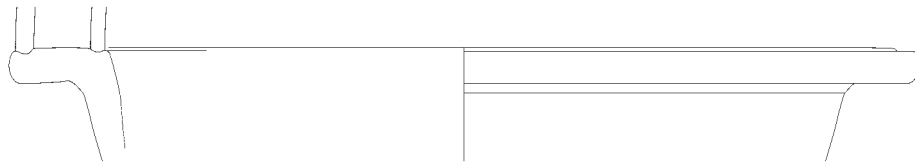

K 439

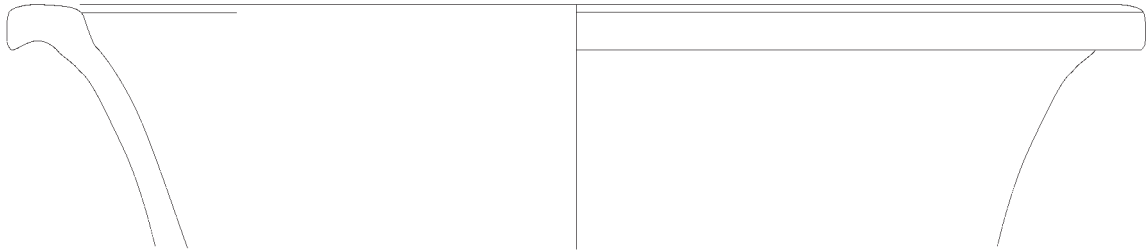

K 440

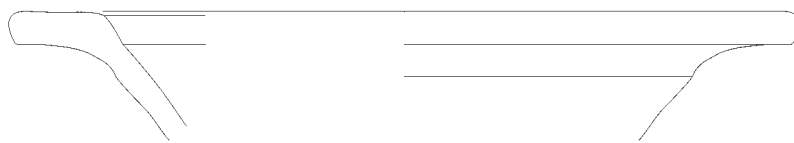

K 441



K 442

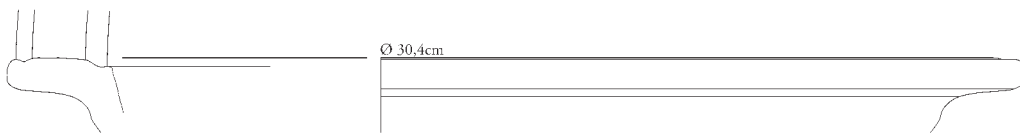

K 443

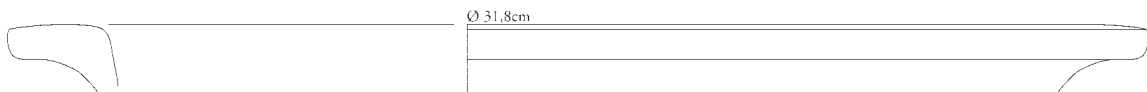

K 444

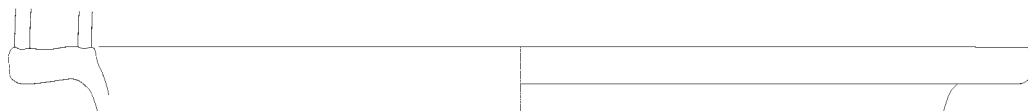

K 445

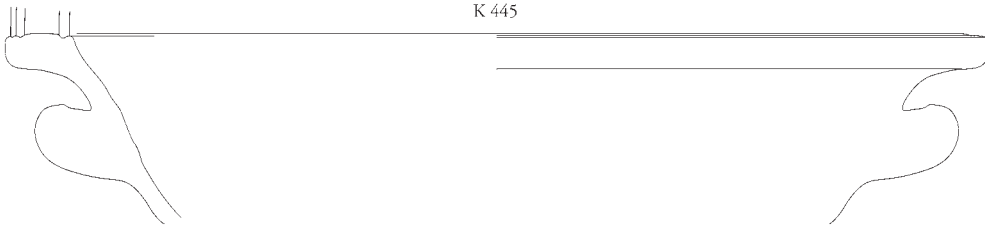

K 446



K 447

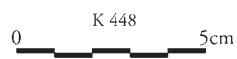
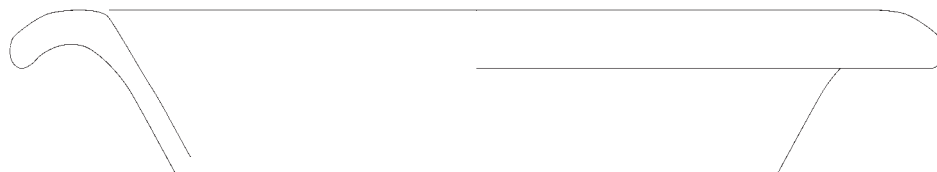

K 439-448

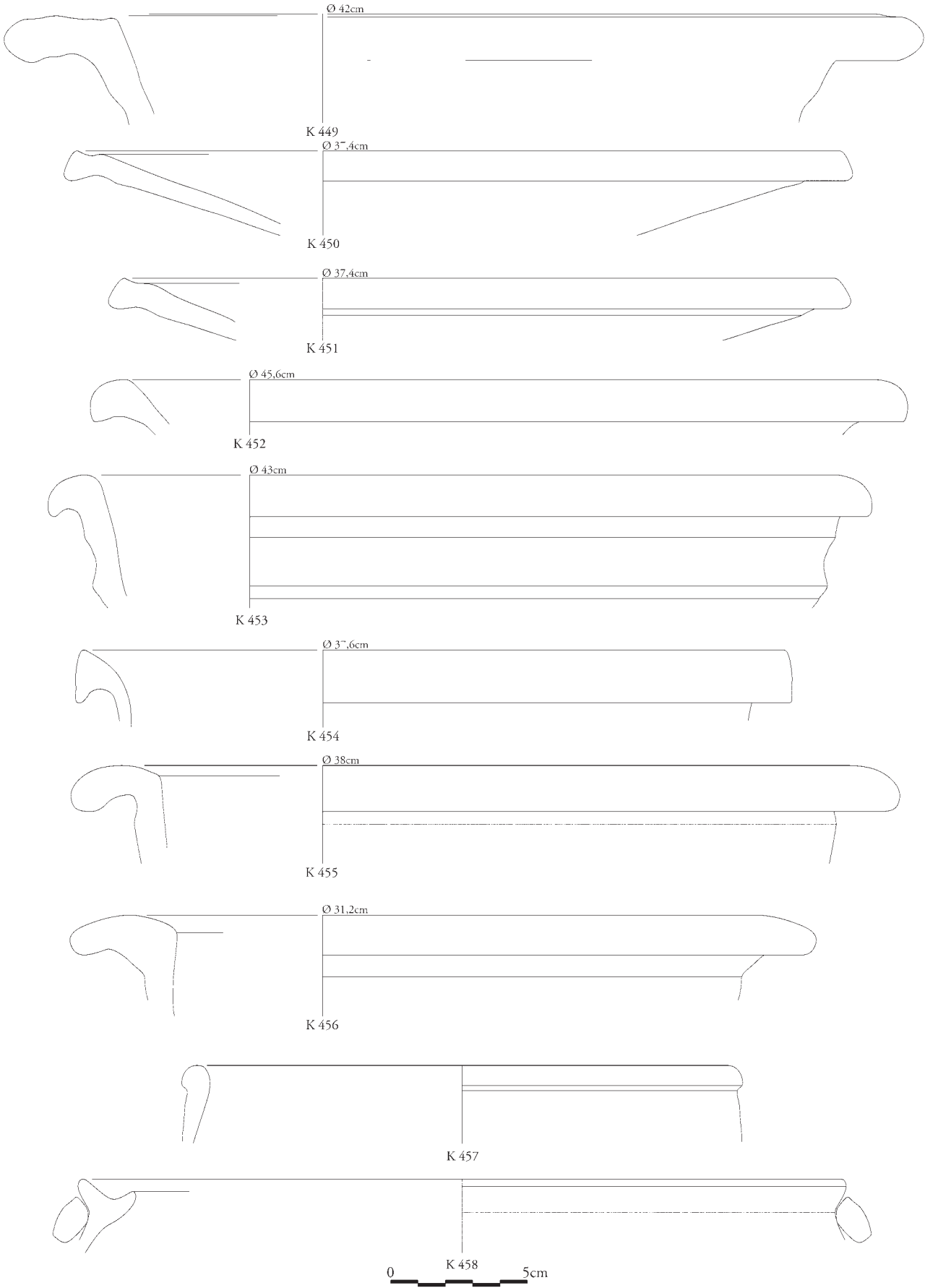

K 449-458

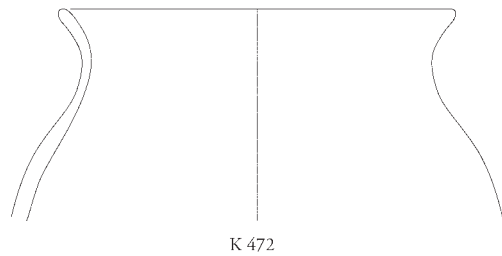
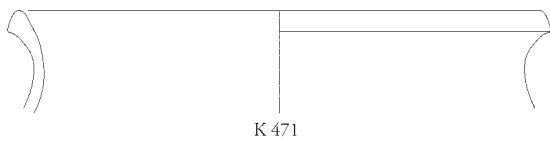
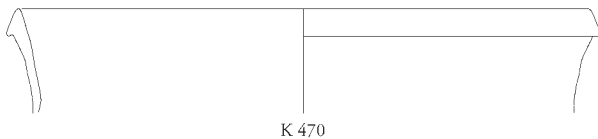
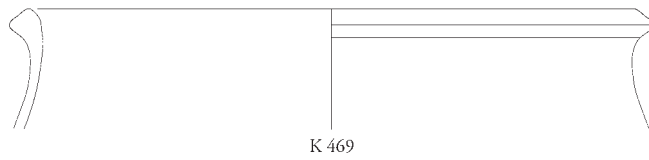
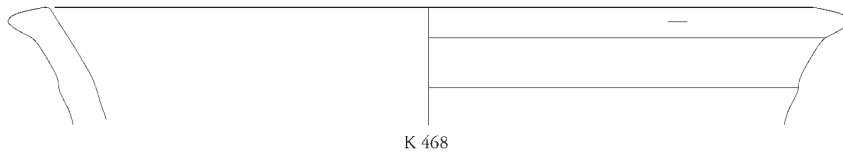
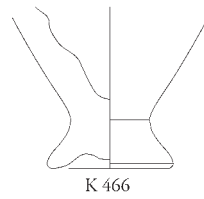
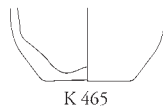
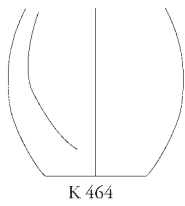
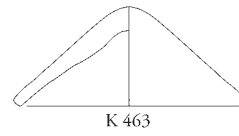
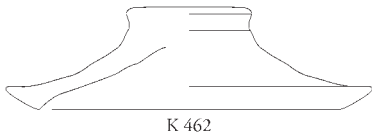
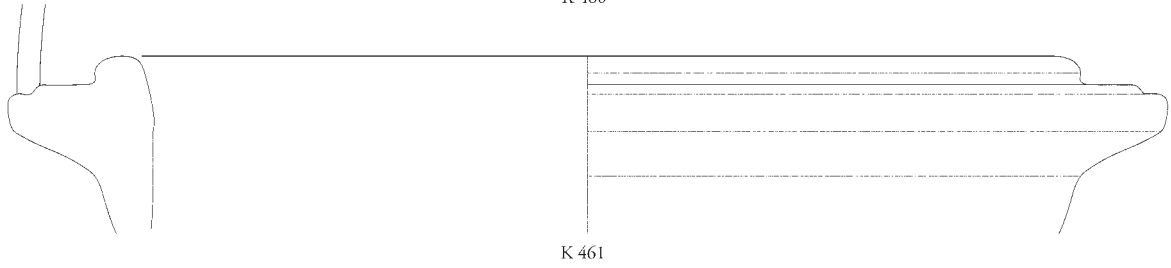
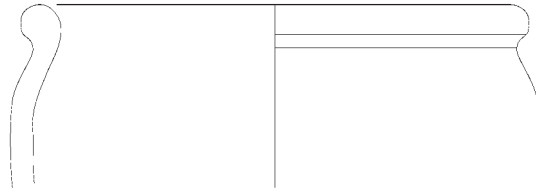
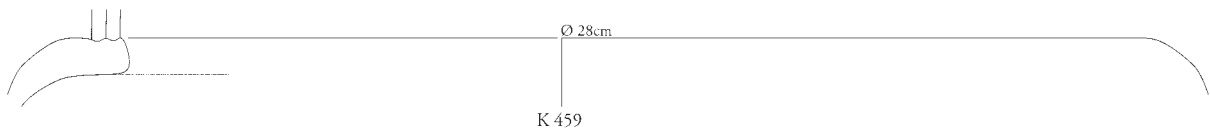

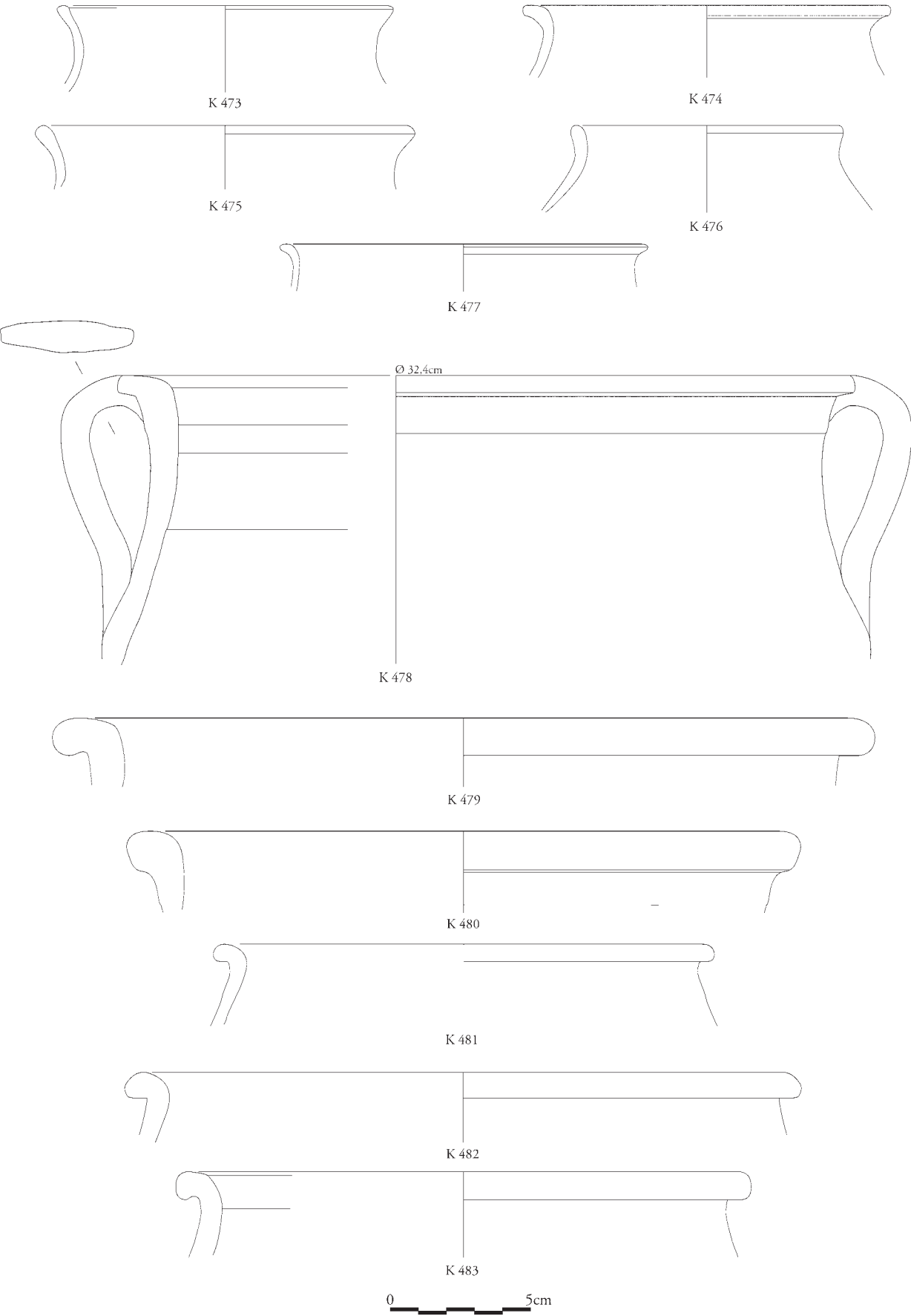

K 473-483

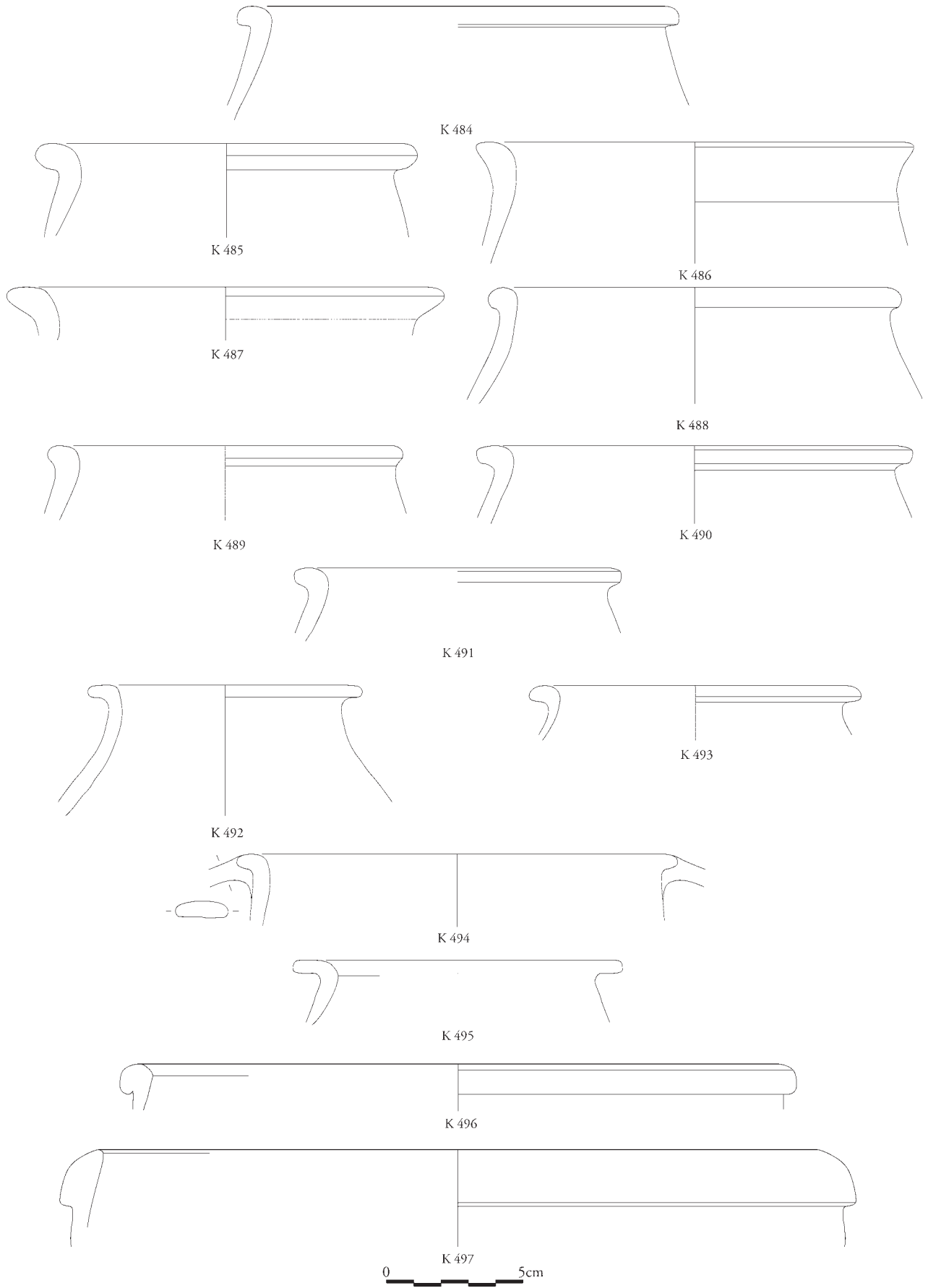

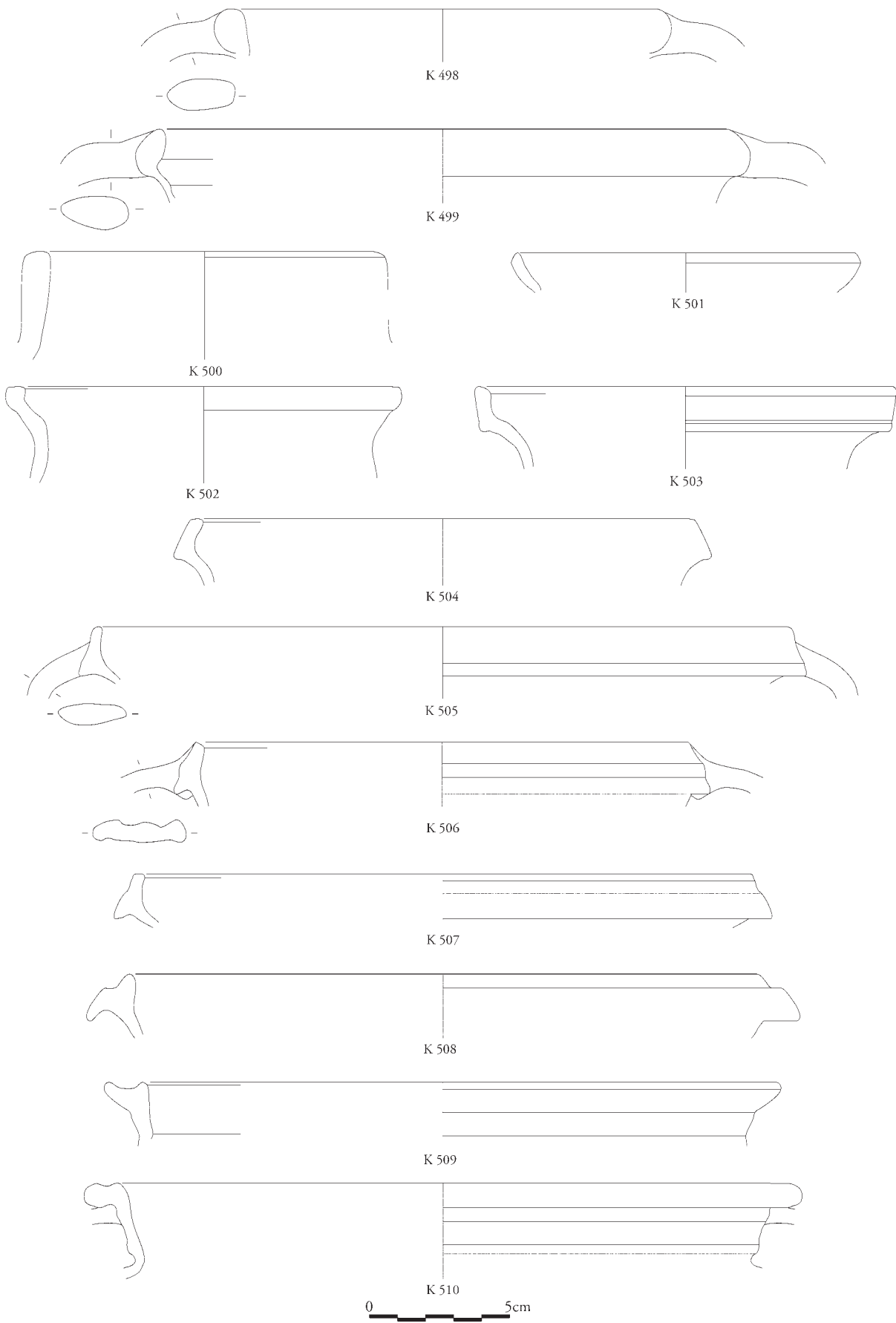

K 498-510

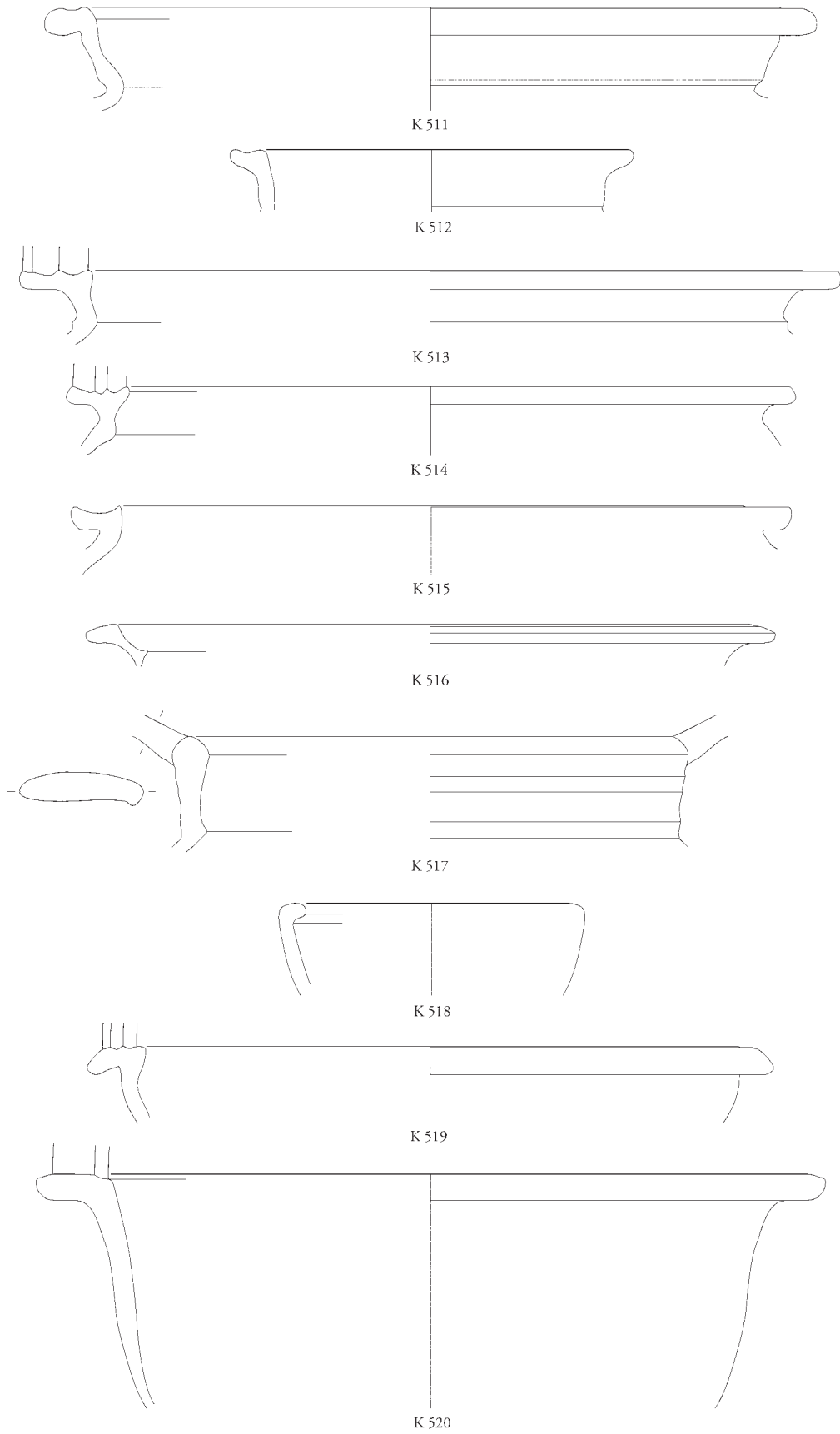

0 5cm

K 511-520

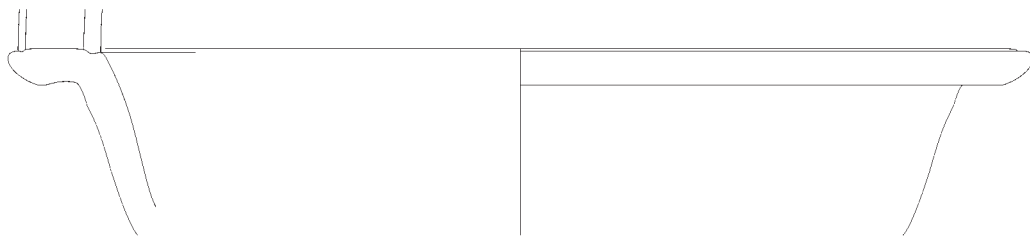

K 521

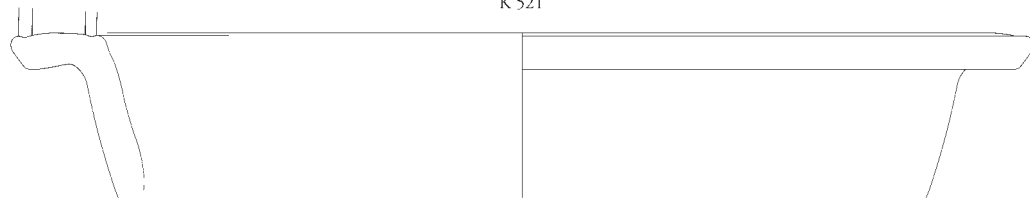

K 522



K 523



K 524

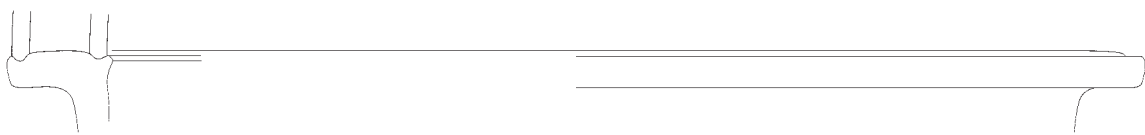

K 525

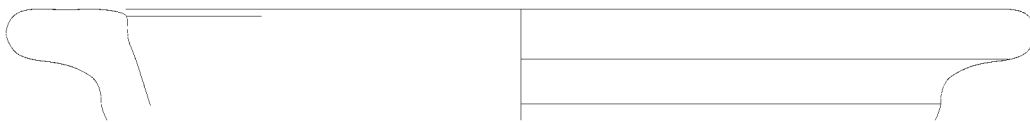

K 526

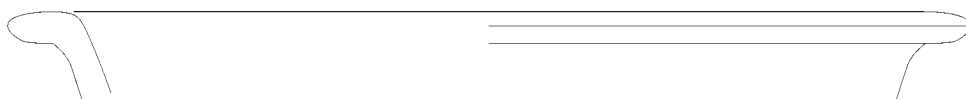

K 527

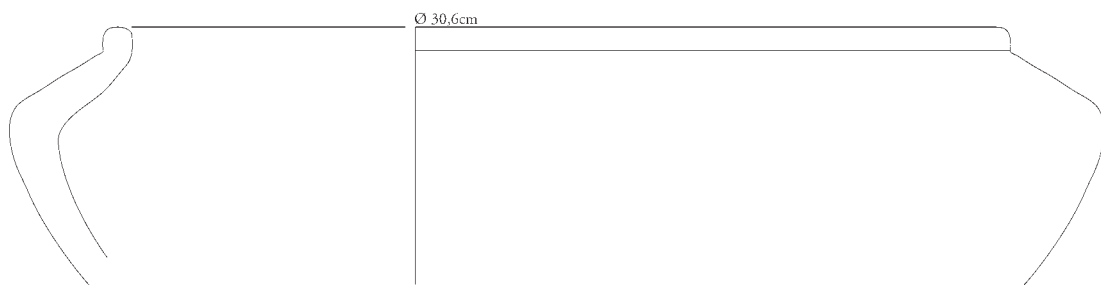

K 528



K 521-528

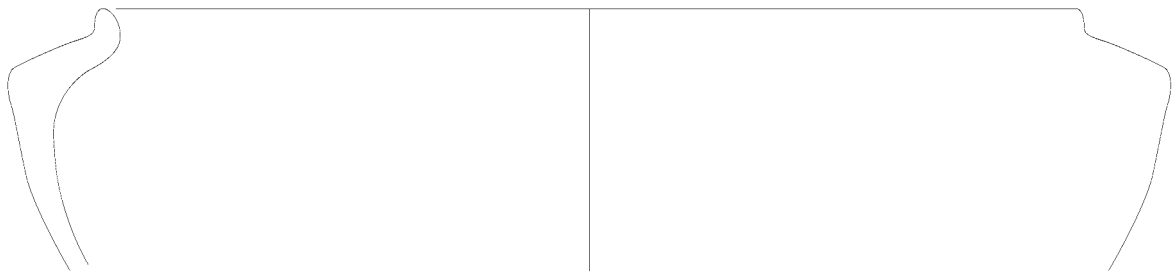

K 529

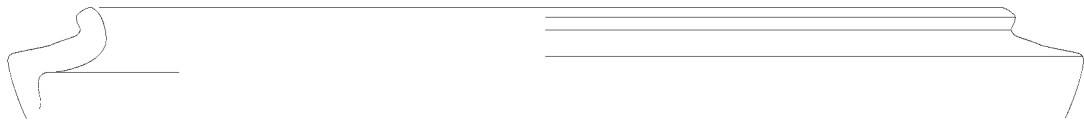

K 530

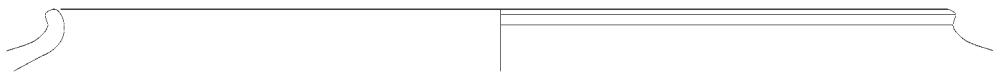

K 531



K 532

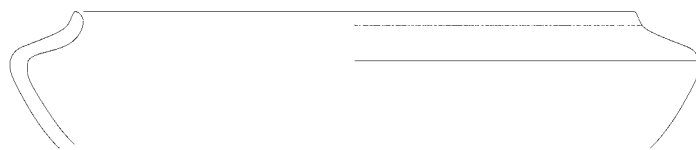

K 533

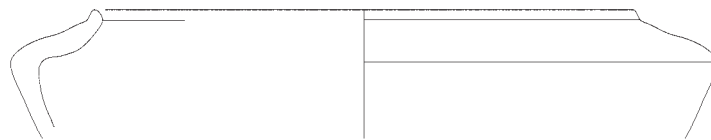

K 534



K 535

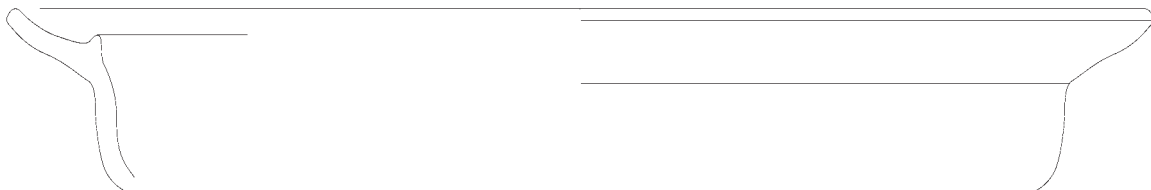

K 536



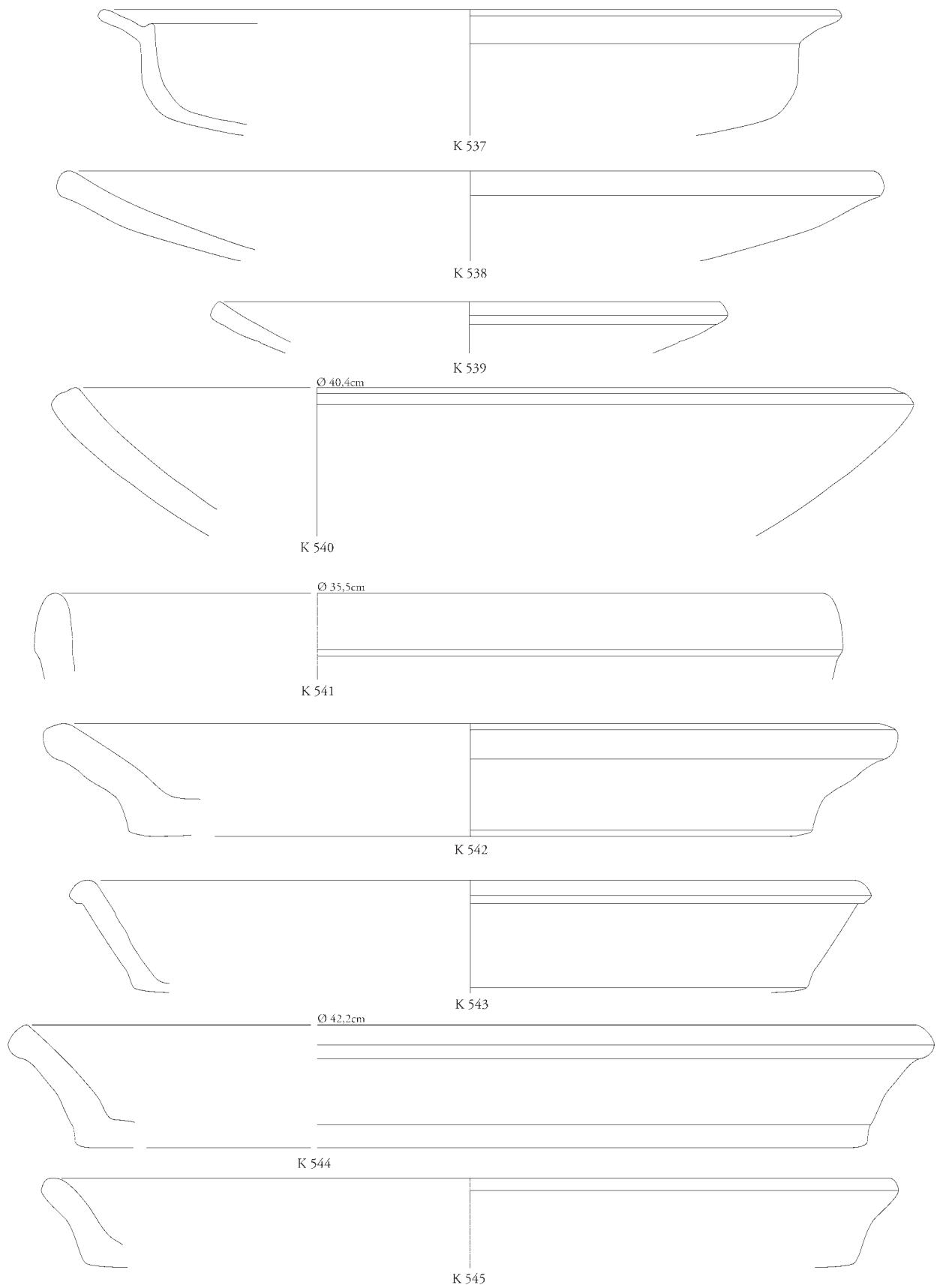

K 537-545

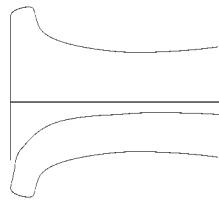

K 546

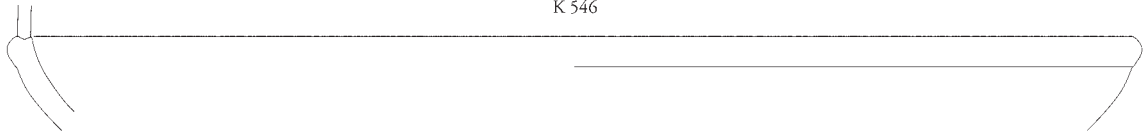

K 547

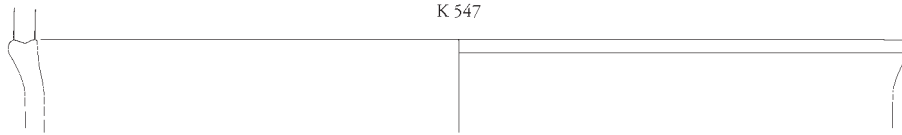

K 548



K 549



K 550

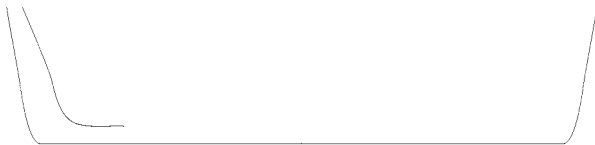

K 551

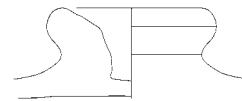

K 552

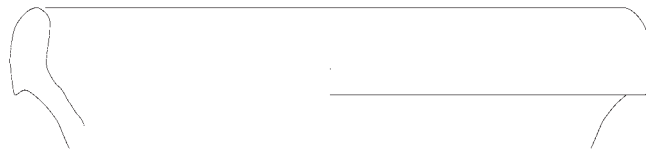

K 553

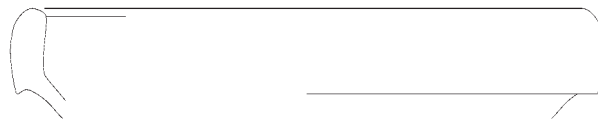

K 554



K 555

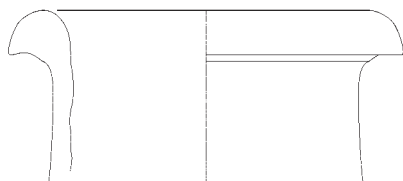

K 556

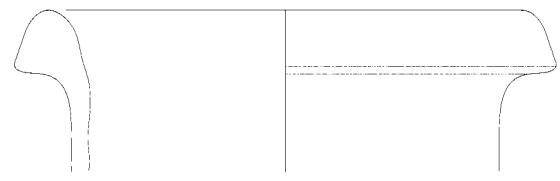

K 557



K 546-557