

## BEILAGEN

-  Firnis
-  Miltos
-  Tongrundig
- w weiße Farbe
-  rezente Ergänzung

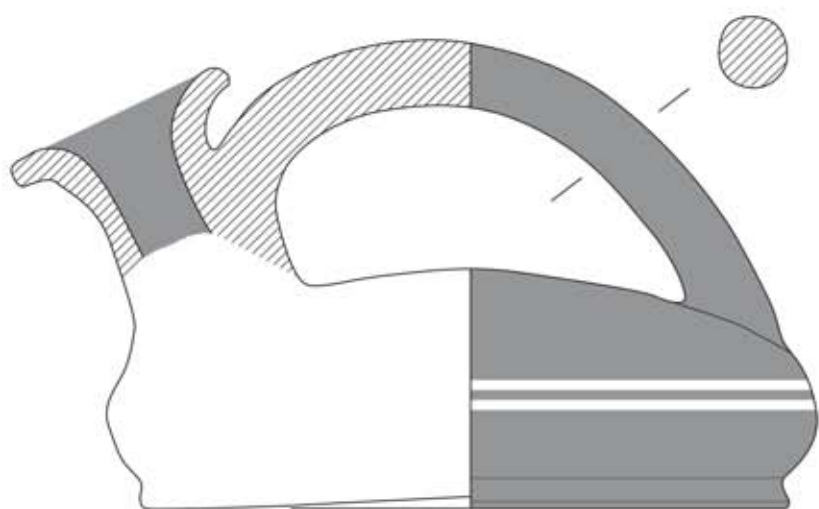

1 (IV 578)

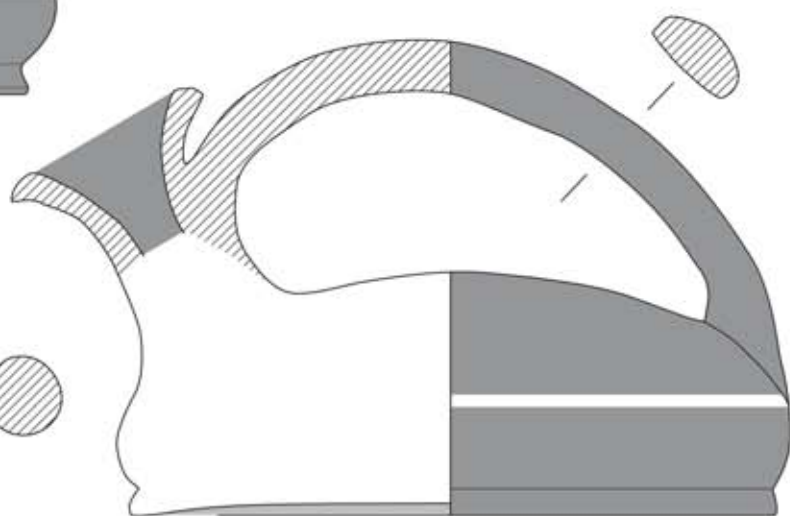

2 (IV 575)

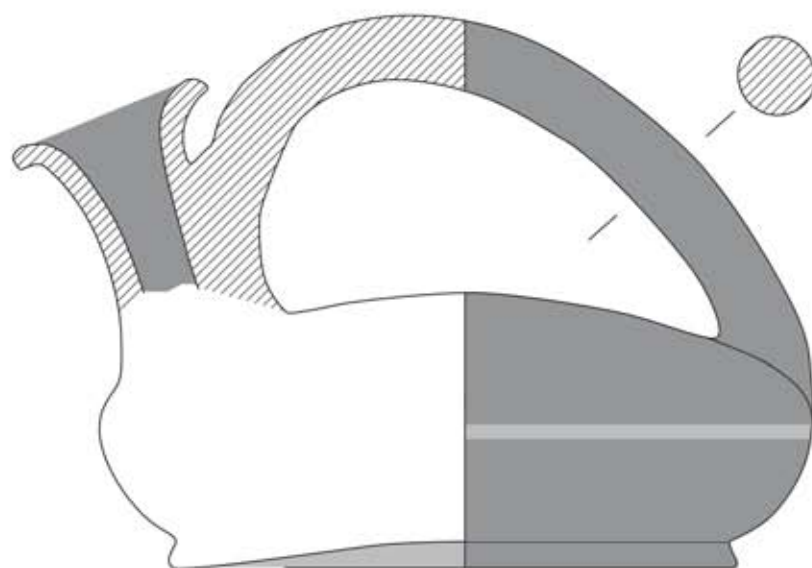

3 (IV 3774)

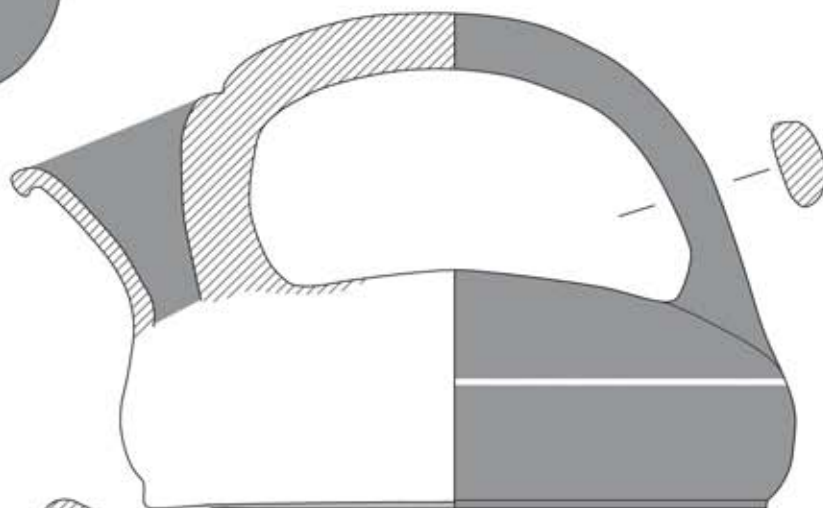

4 (IV 492)

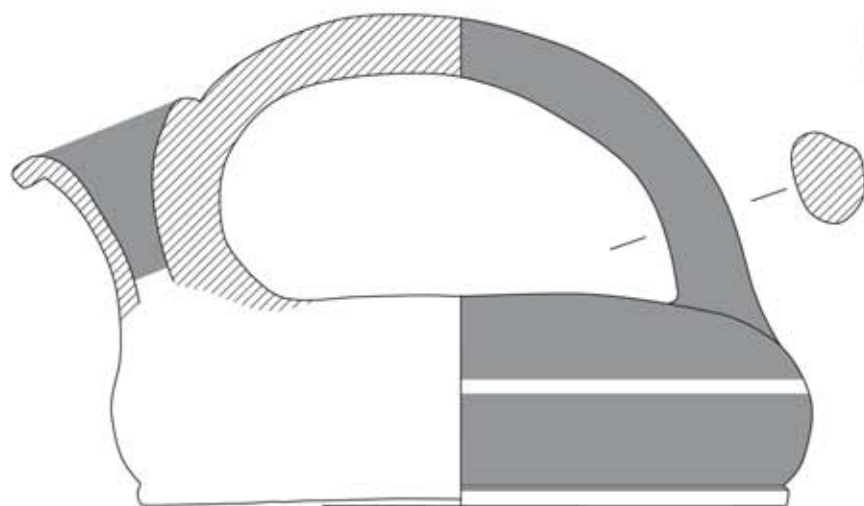

5 (IV 574)



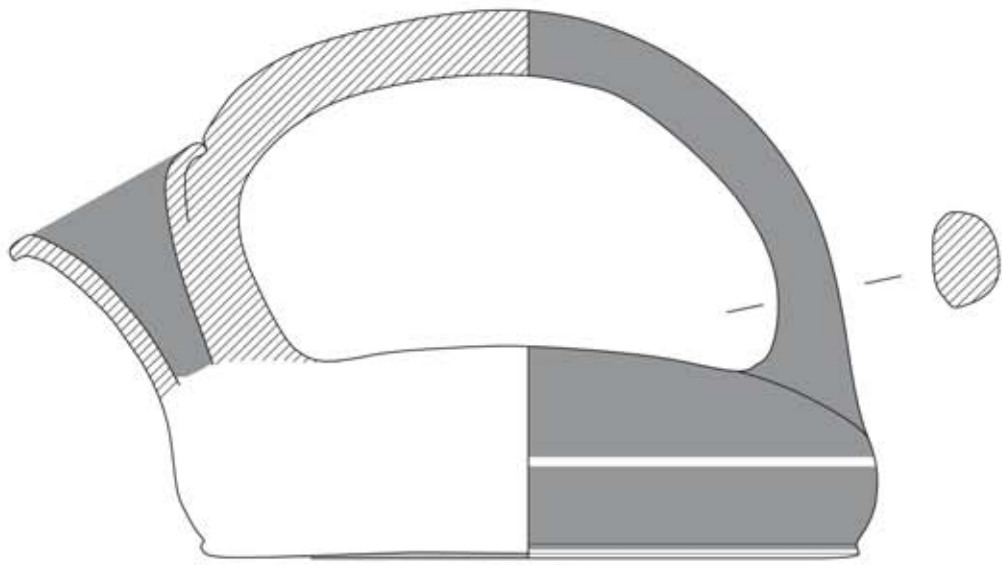

1 (IV 573)

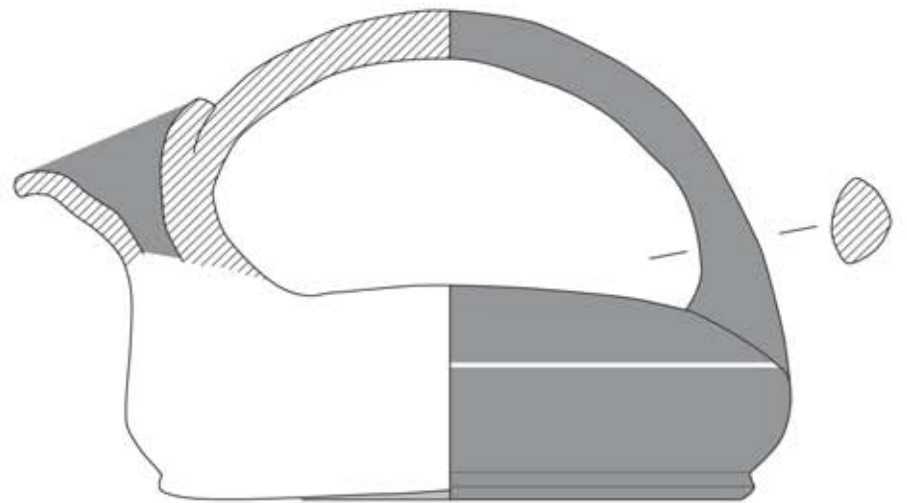

2 (IV 577)

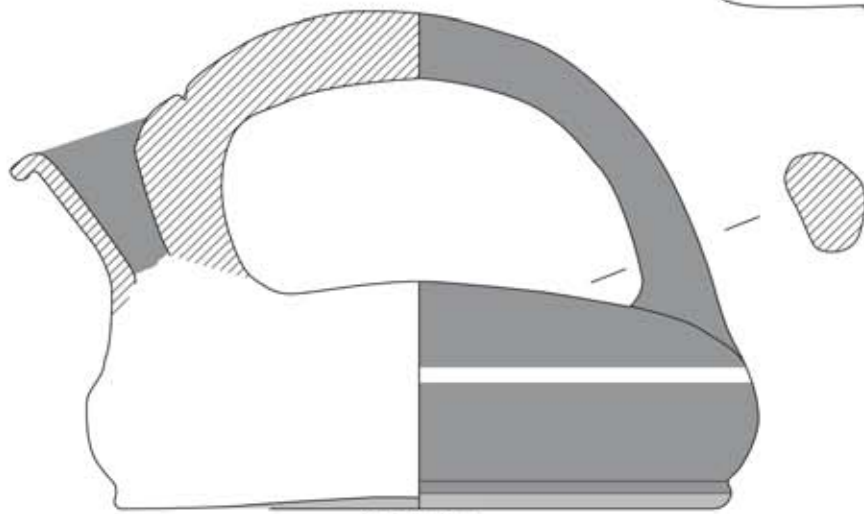

3 (IV 491)

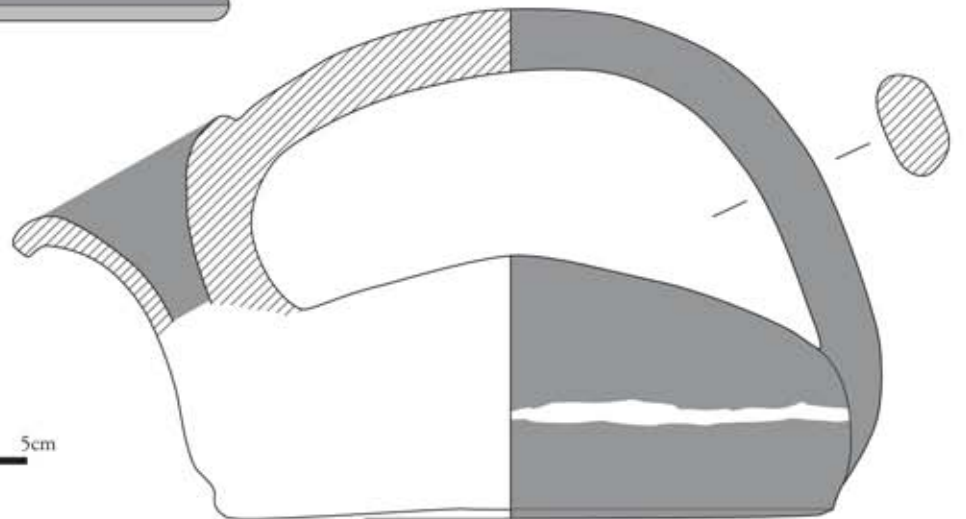

4 (IV 576)



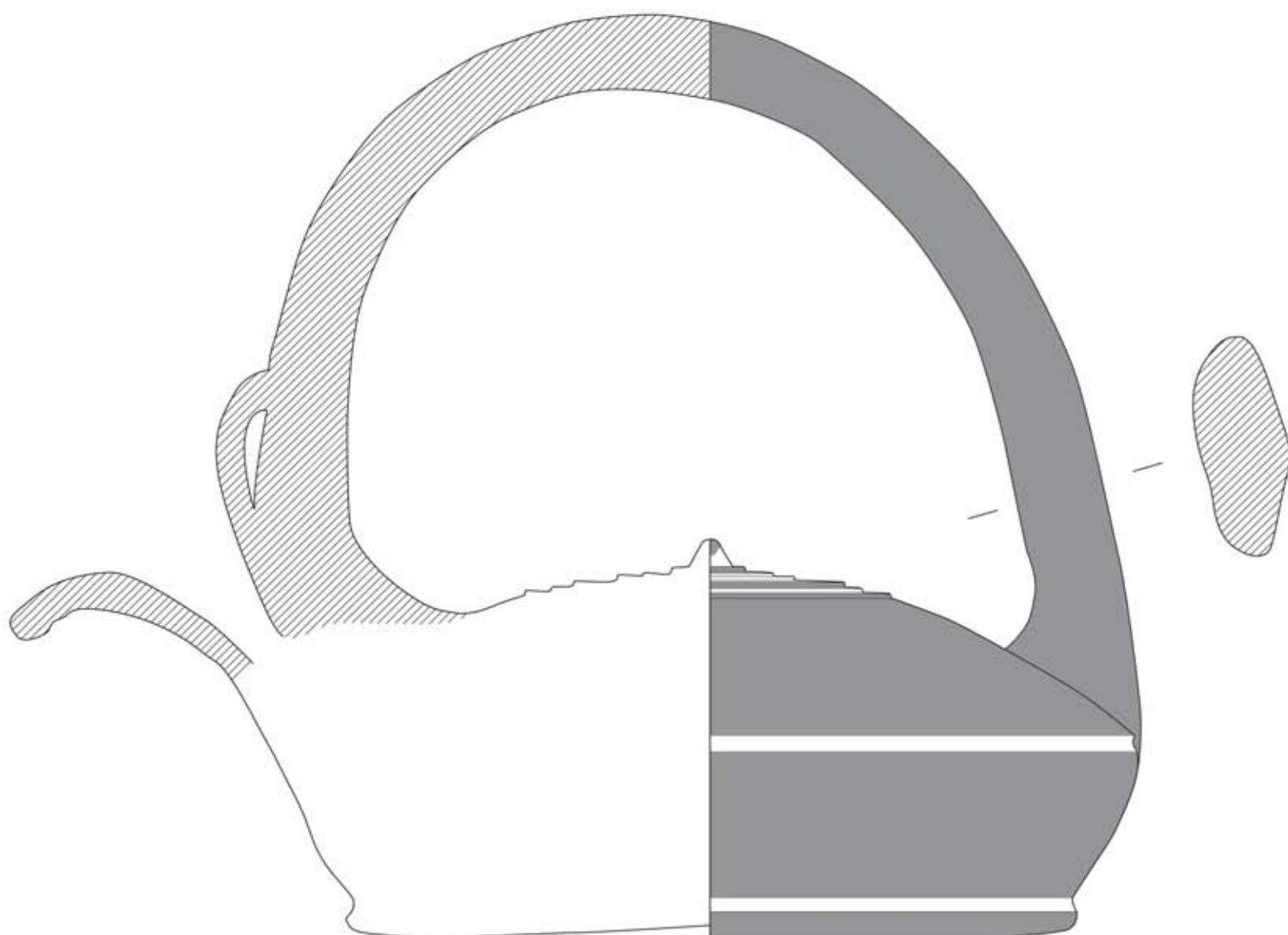

1 (IV 1037)

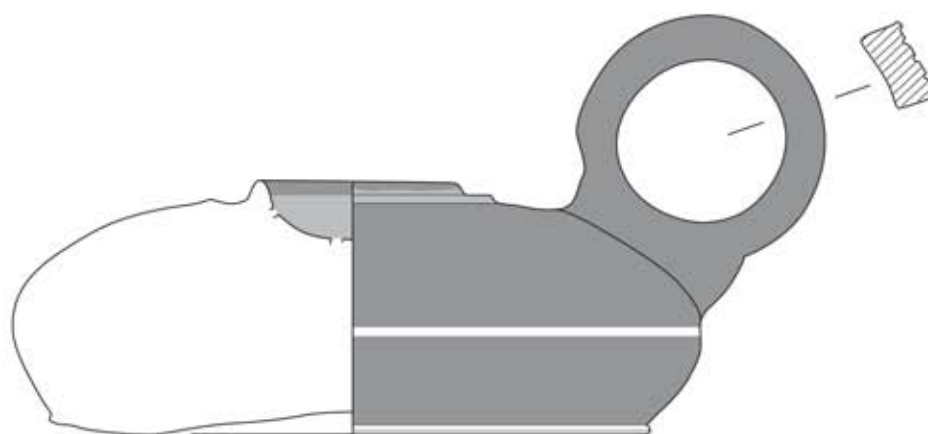

2 (IV 493)



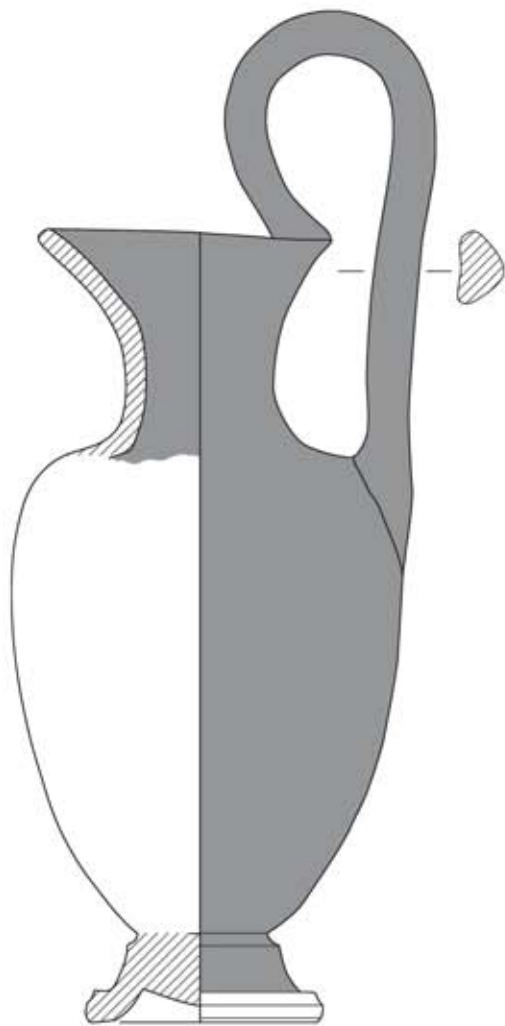
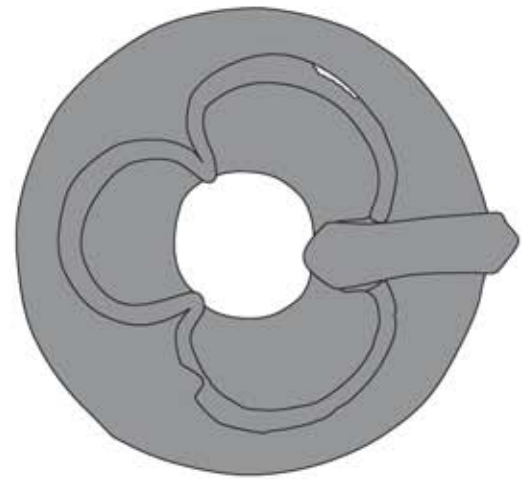
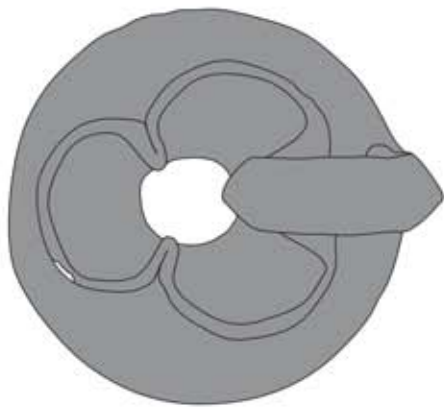

1 (IV 394)

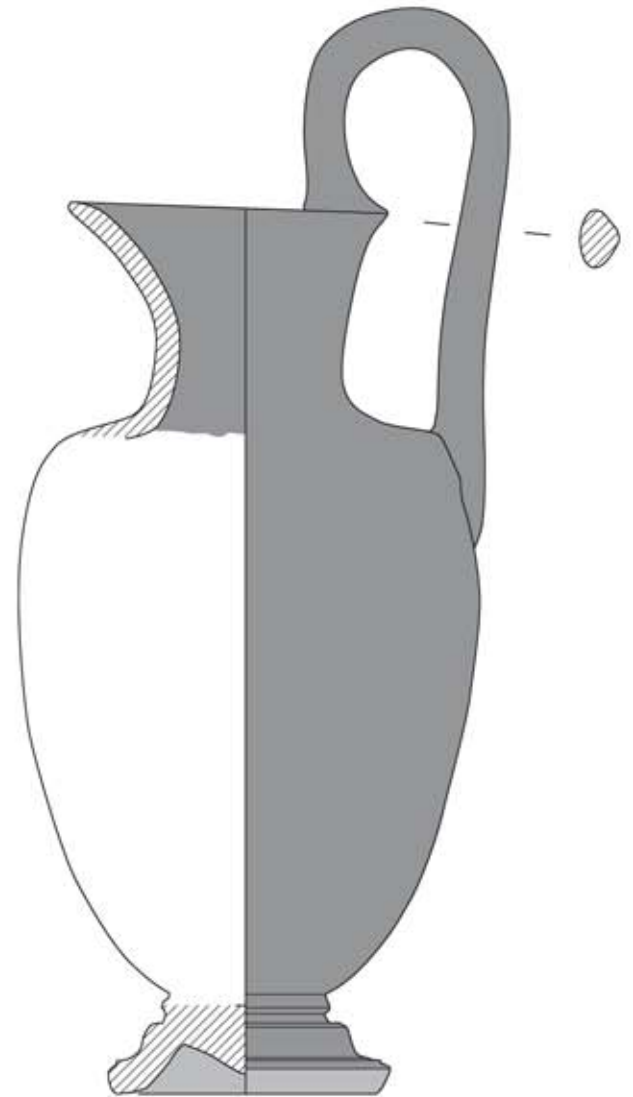

2 (IV 508)



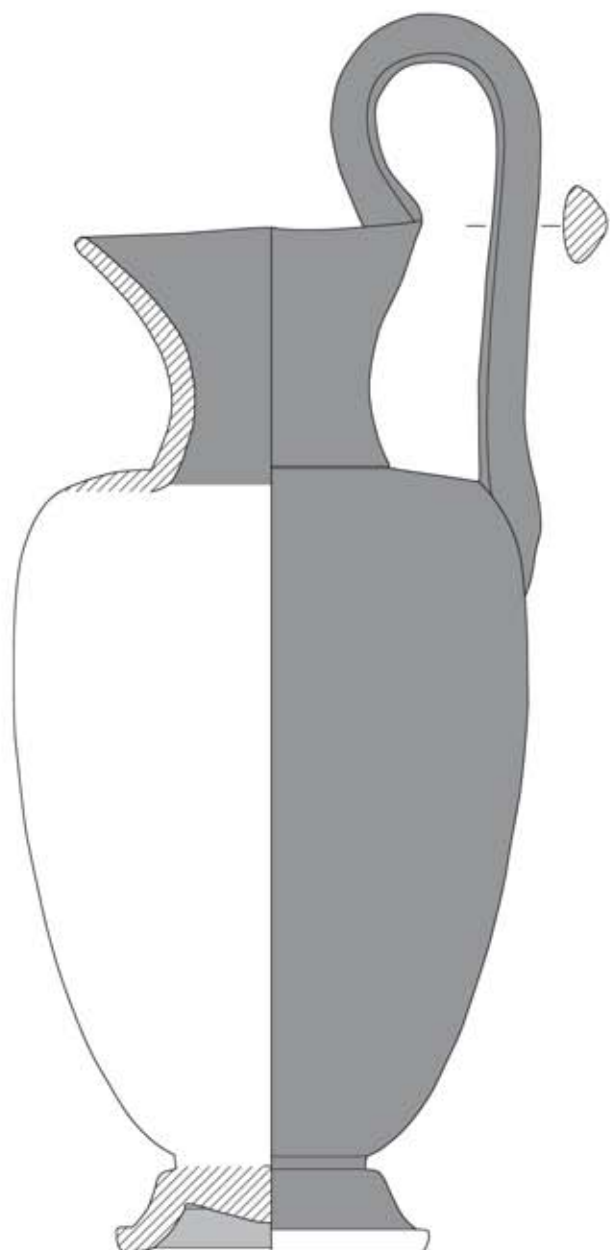
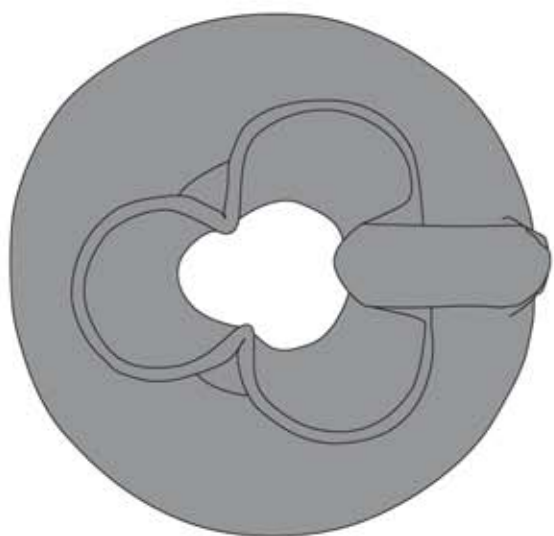

1 (IV 350)

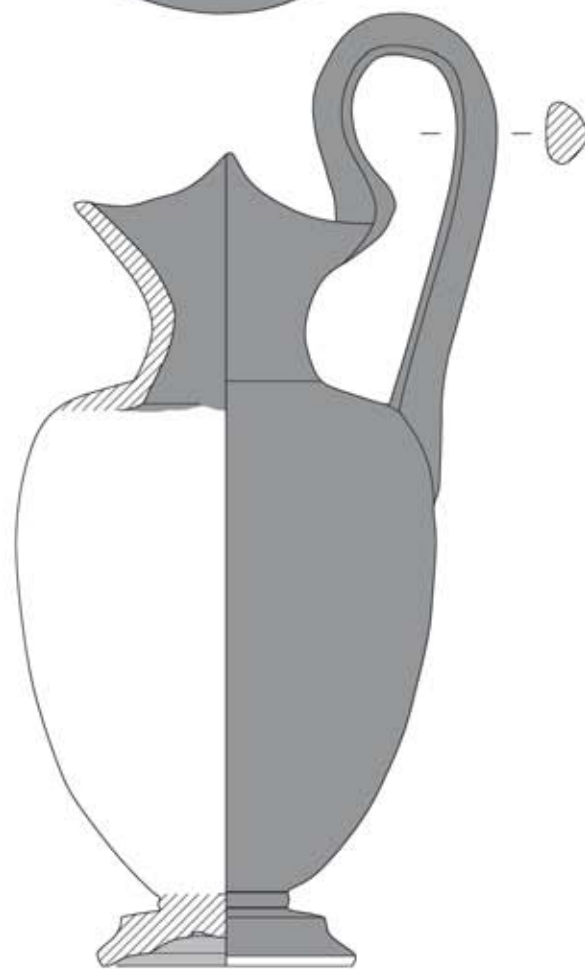
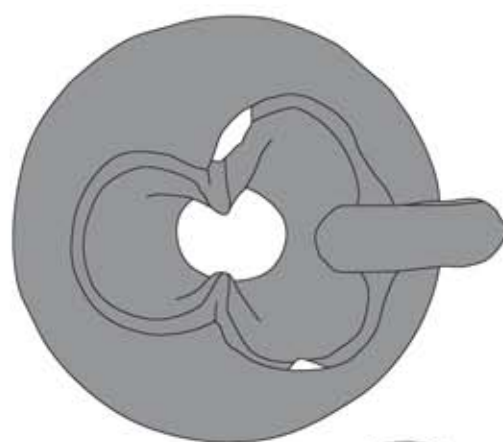

2 (IV 1920)



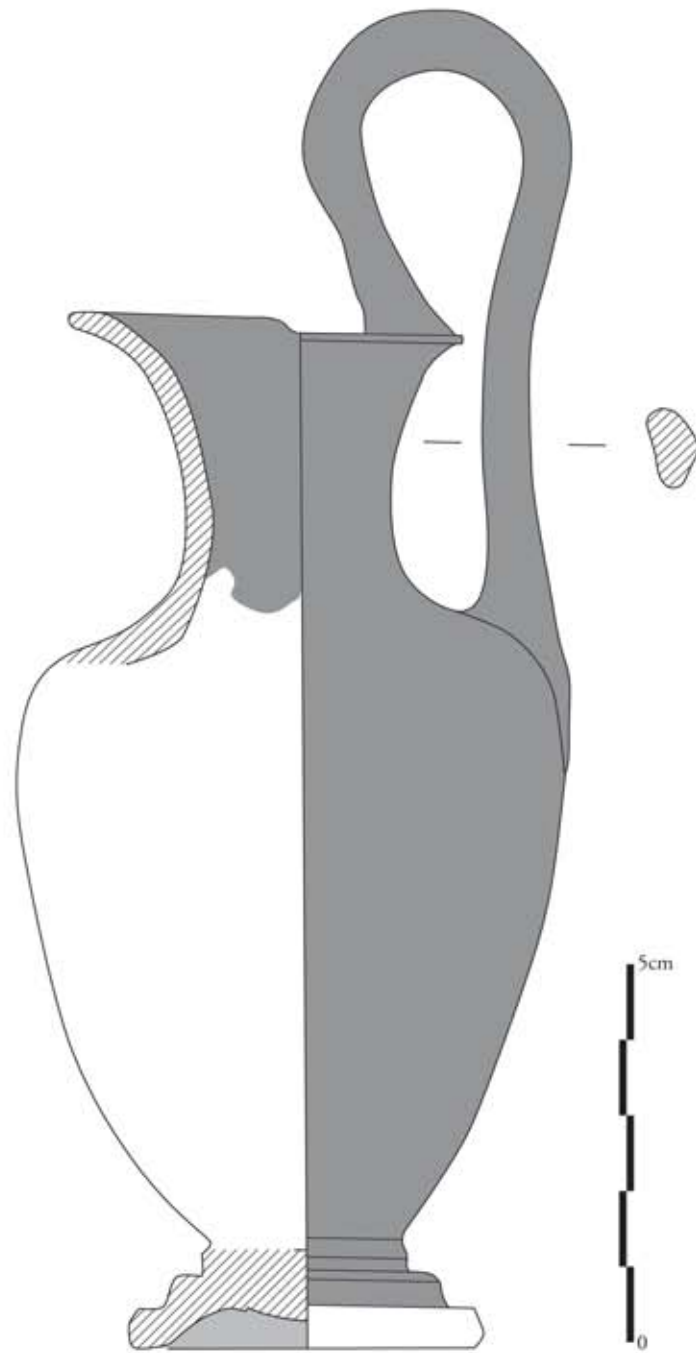
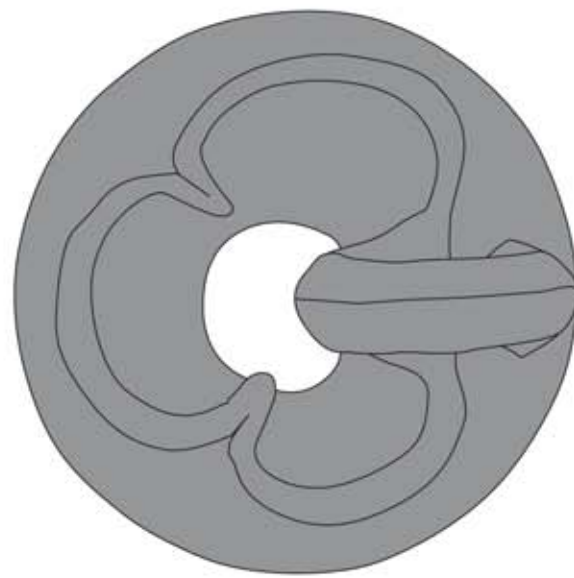

1 (IV 3769)



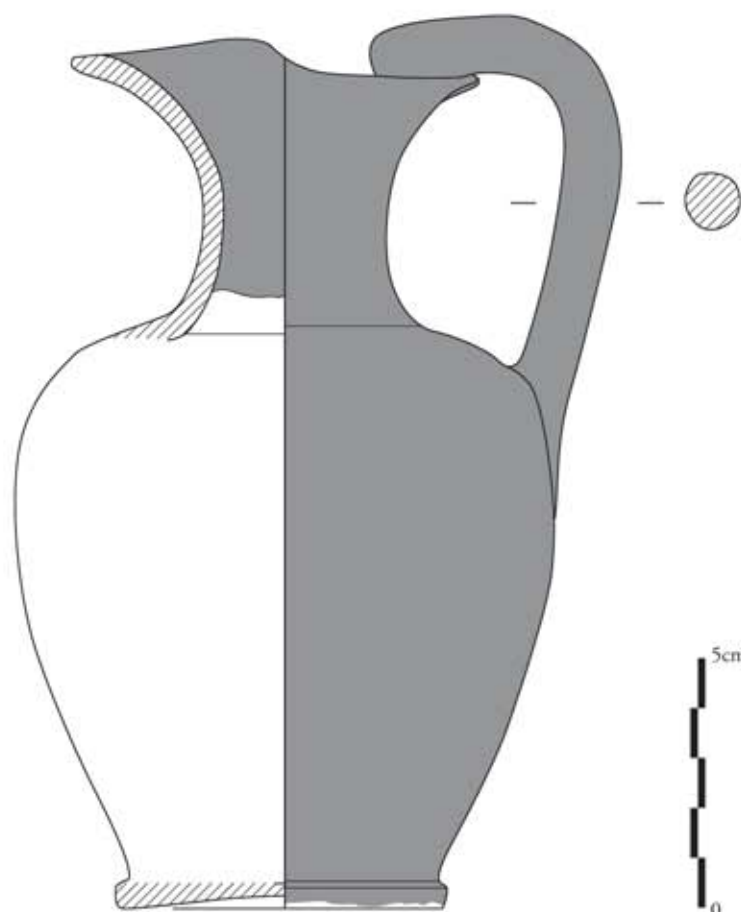
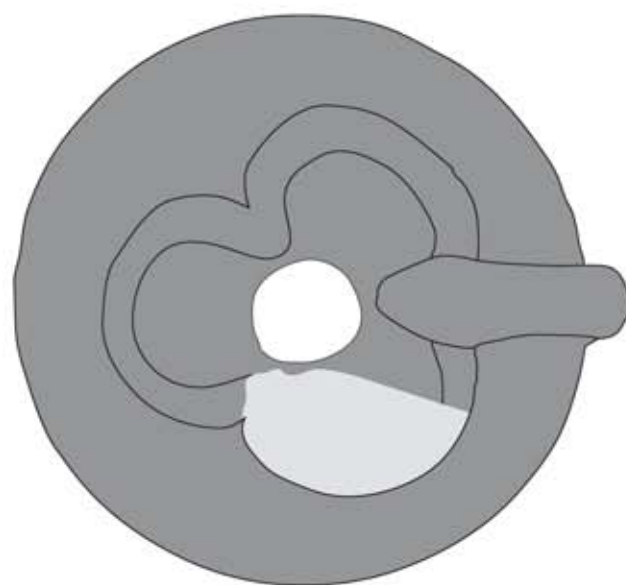
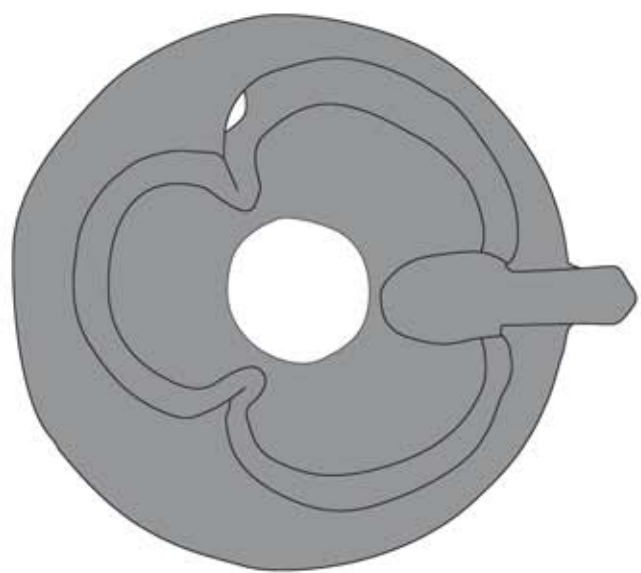

1 (IV 677)

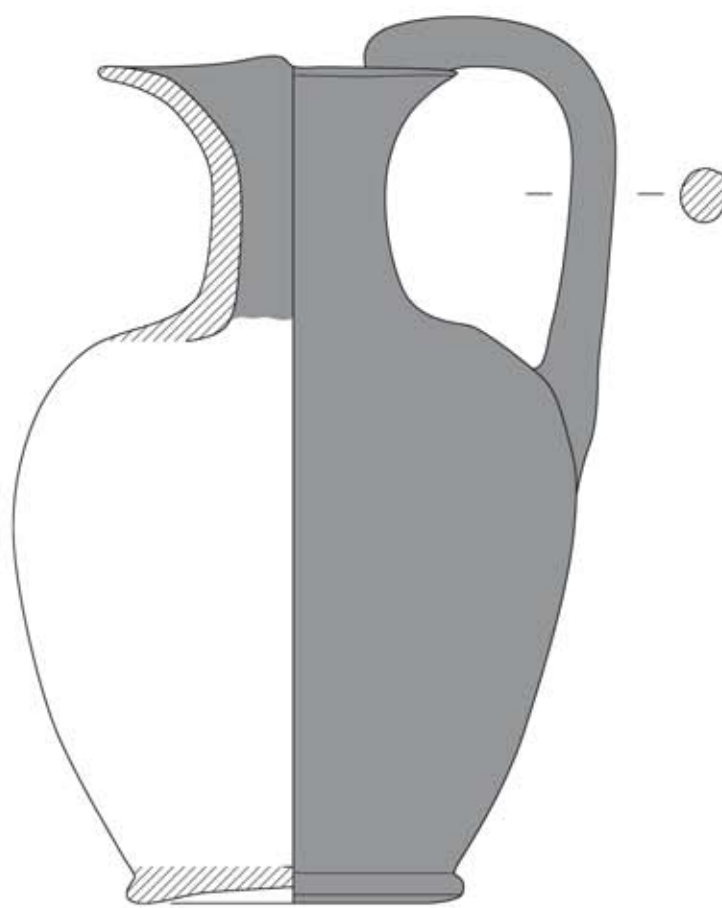

2 (IV 762)

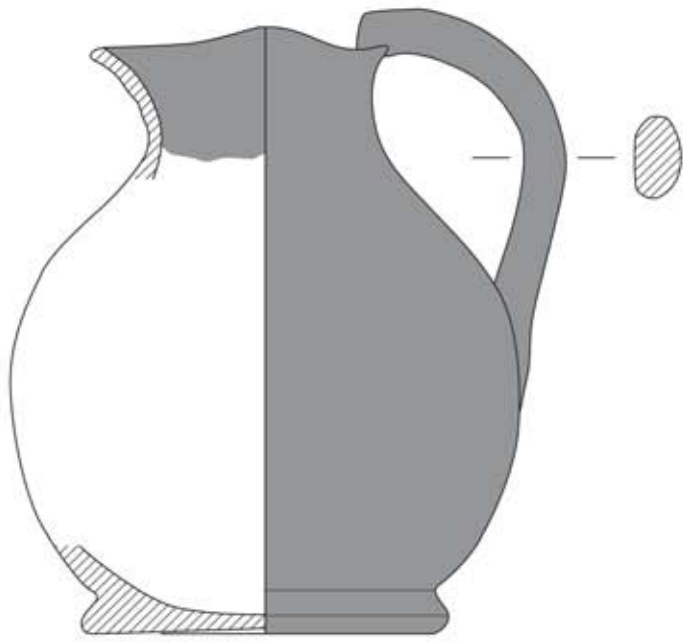
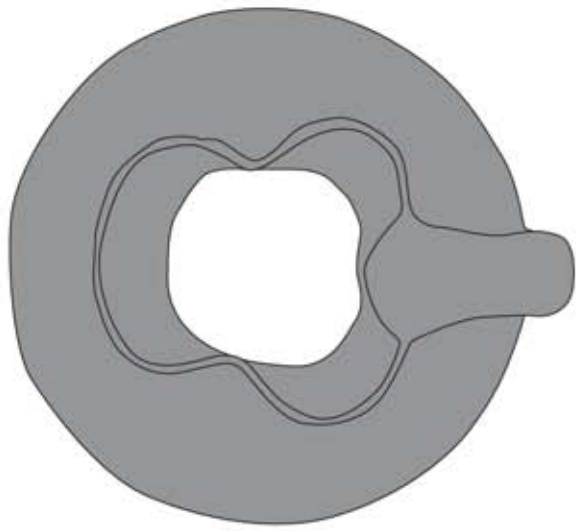

1 (IV 352)

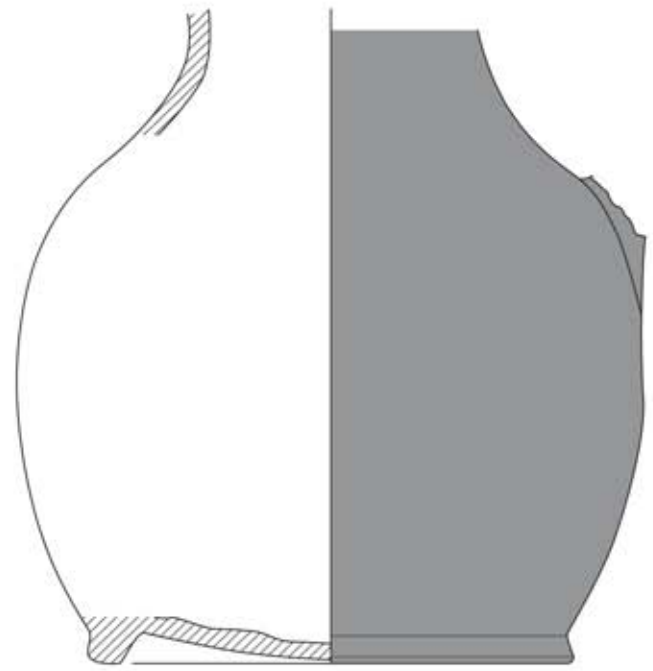

2 (IV 3772)

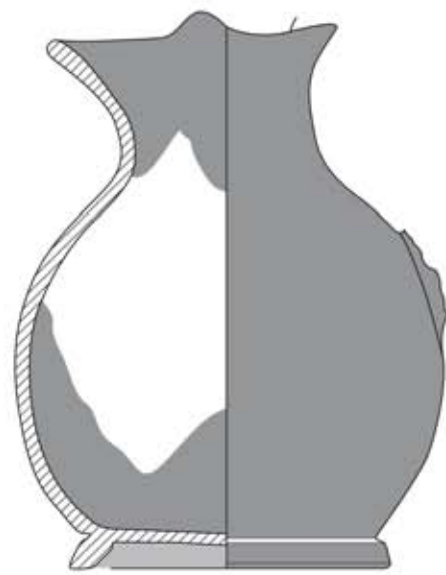

3 (IV 3773)

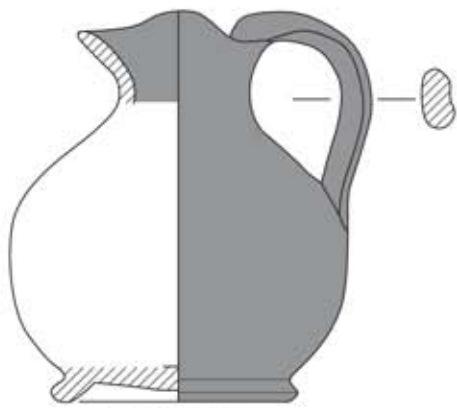
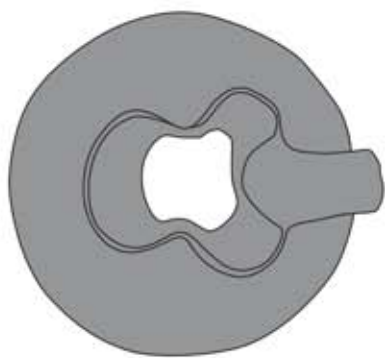

4 (IV 1972)

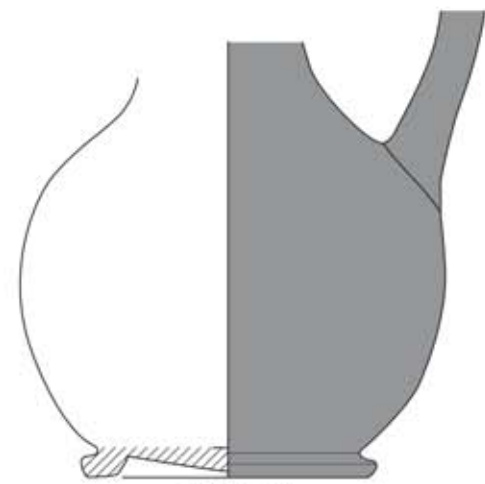

5 (IV 1973)

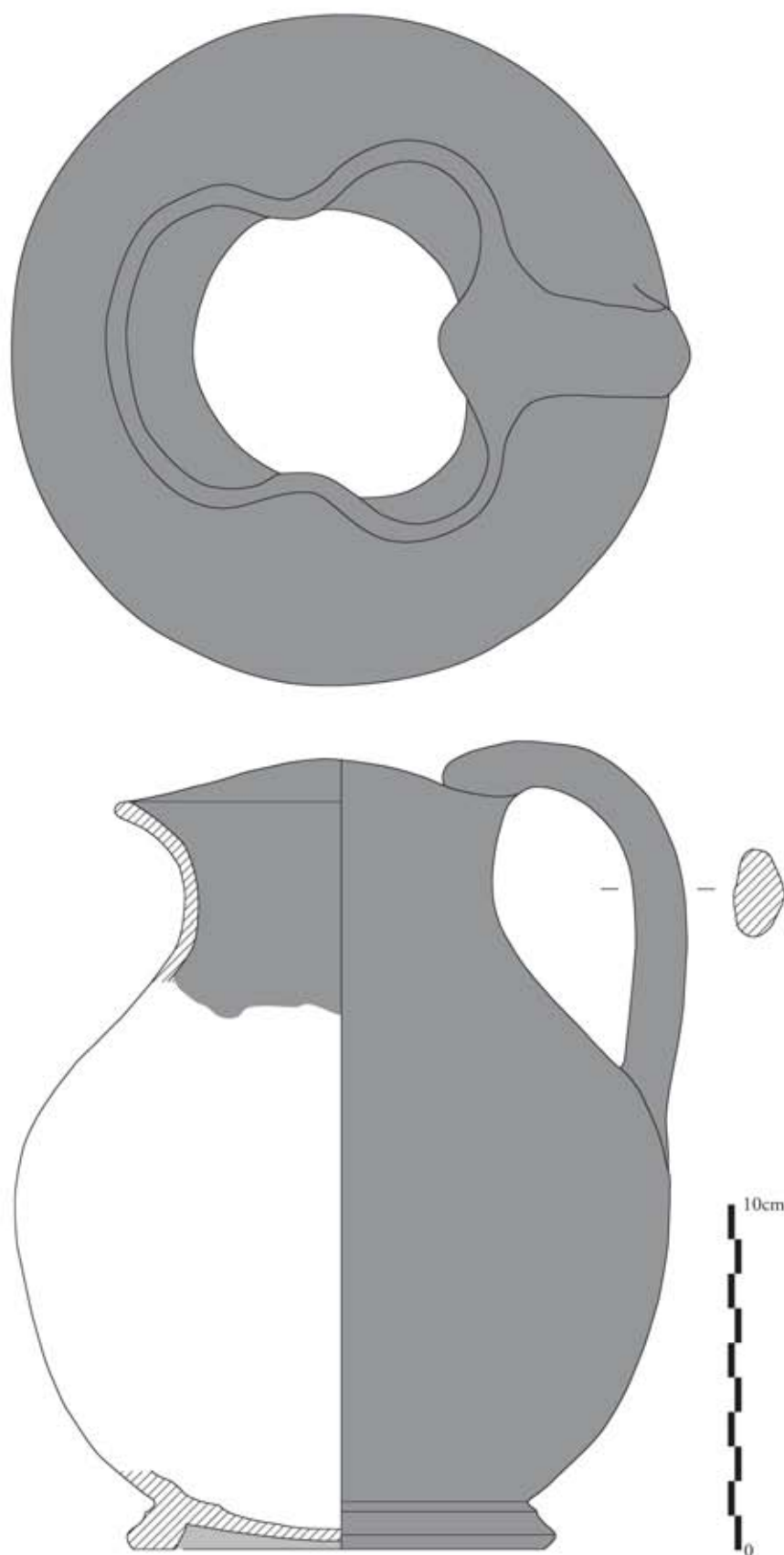

1 (IV 1043)

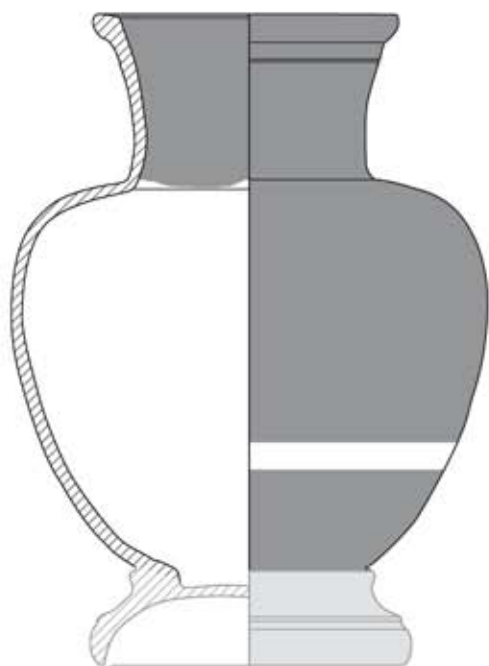

1 (IV 898)

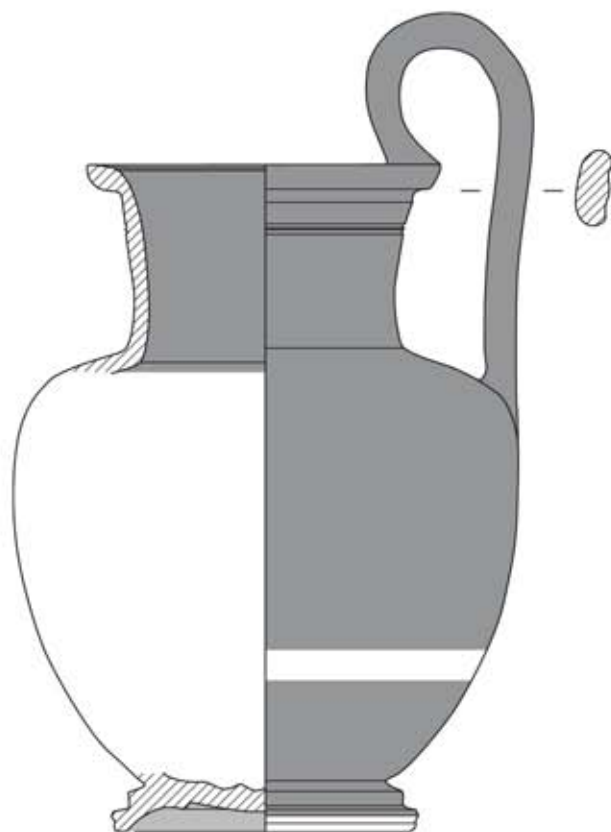

2 (IV 863)

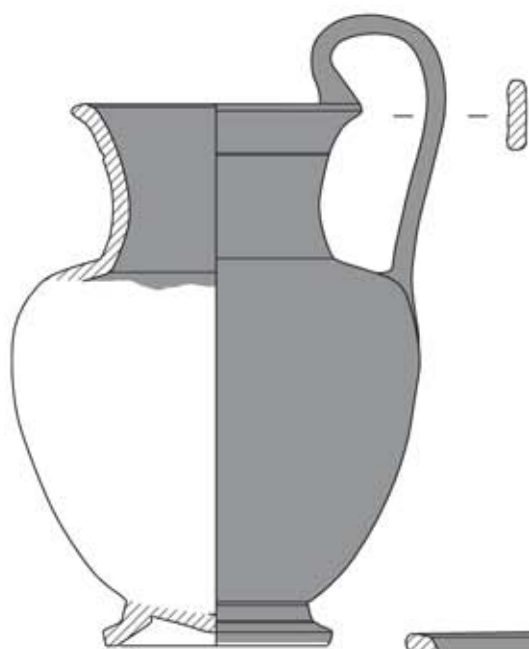

3 (IV 938)

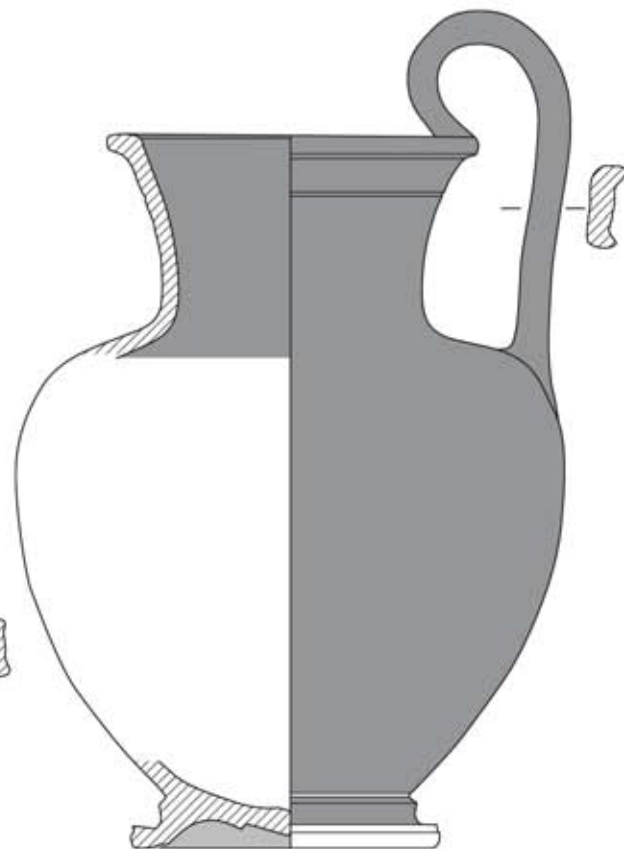

4 (IV 864)

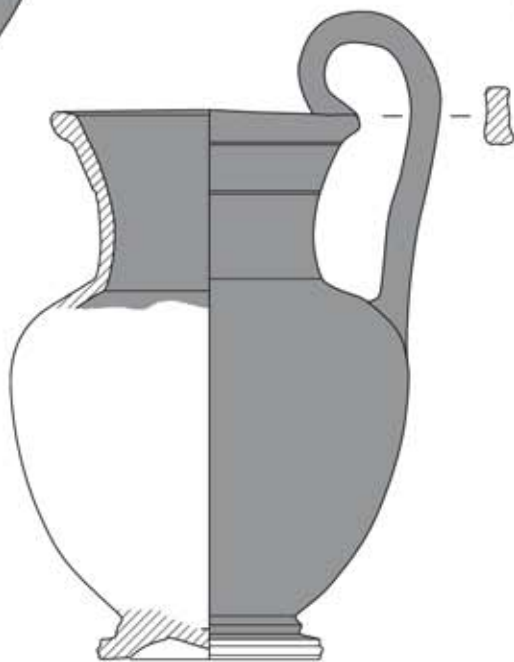

5 (IV 940)

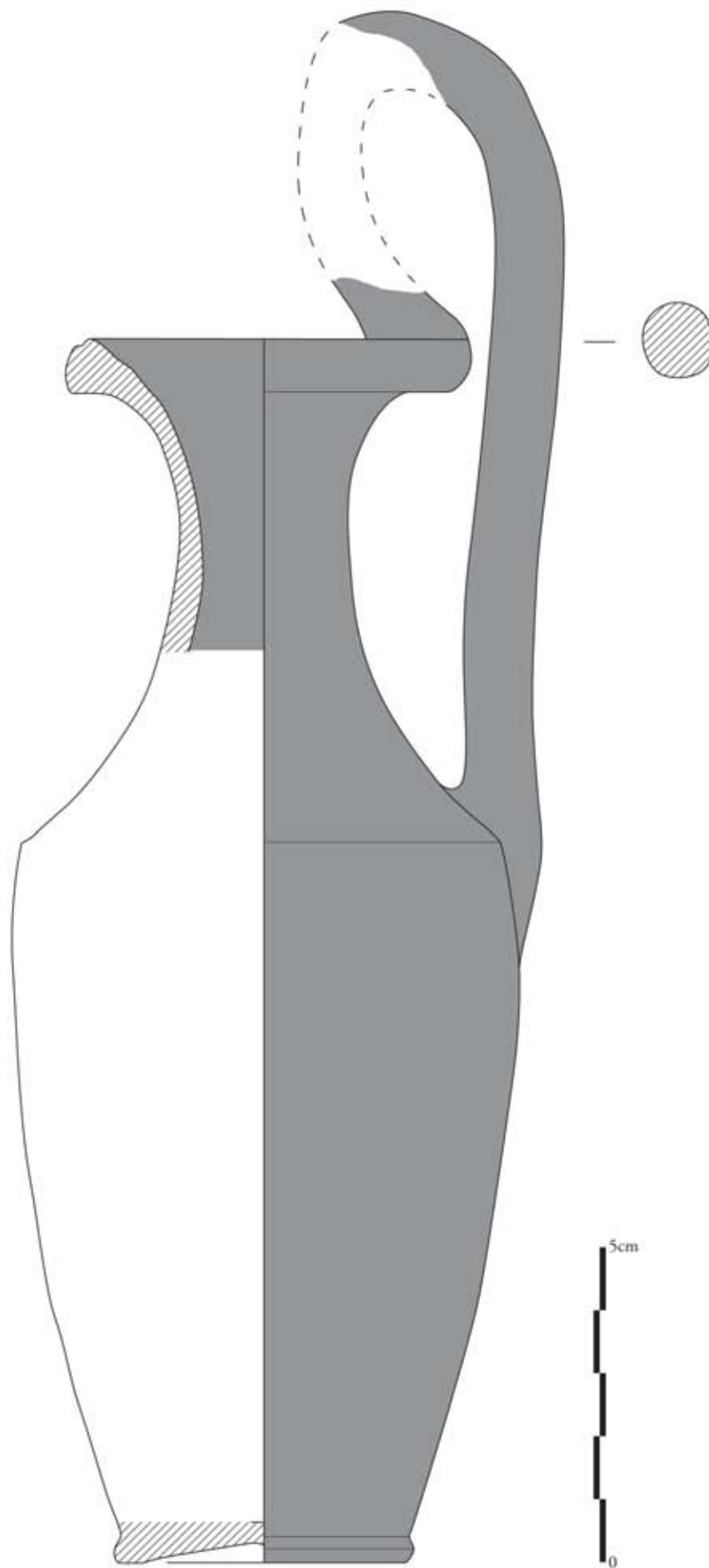

1 (IV 383)

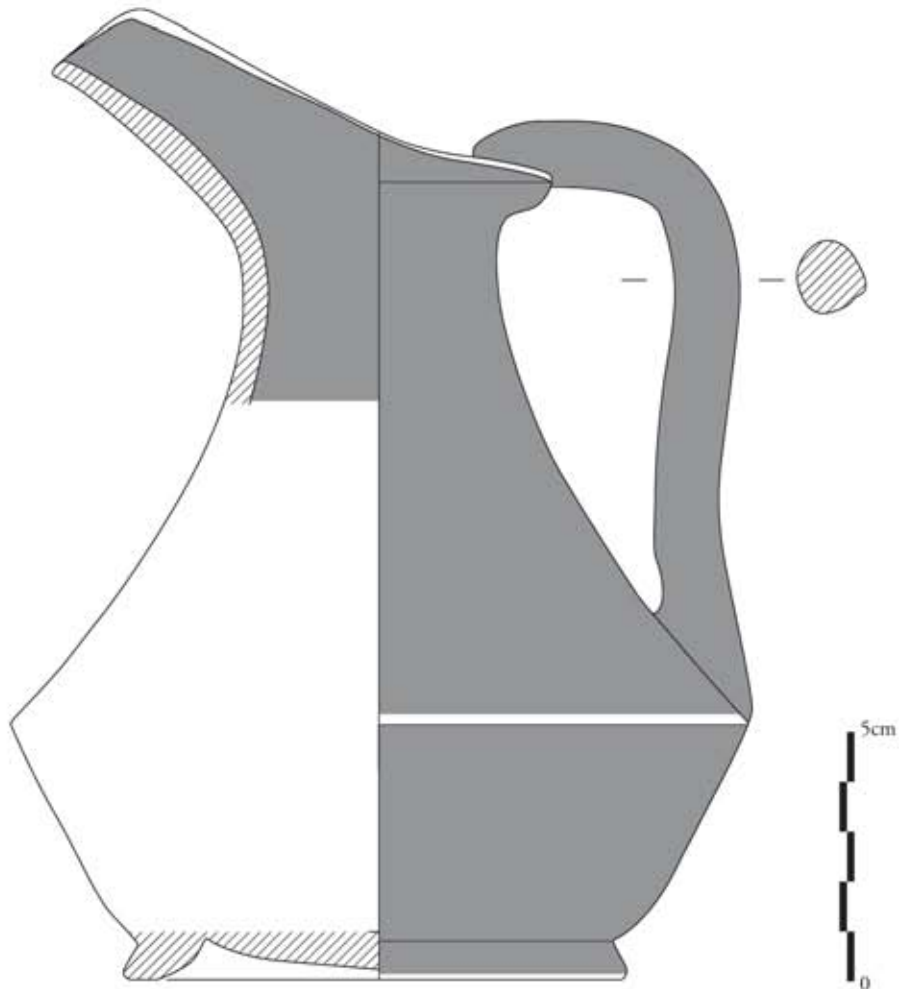
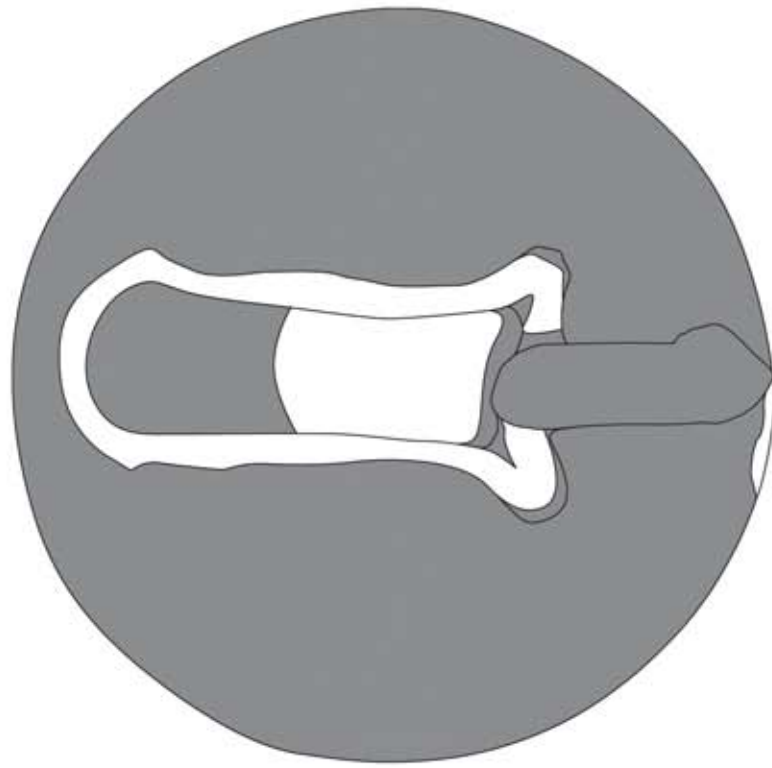

1 (IV 3771)

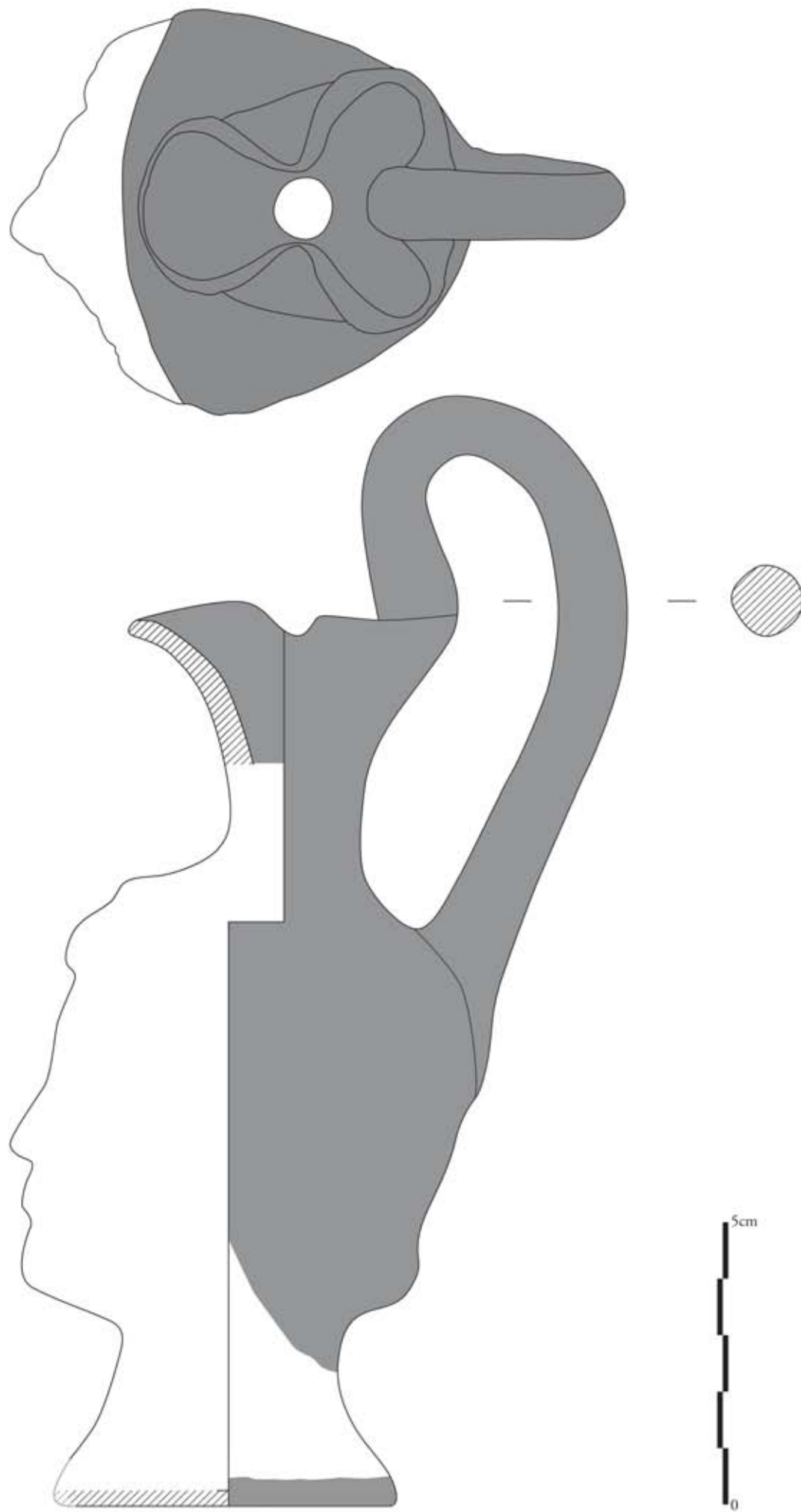

1 (IV 4550)

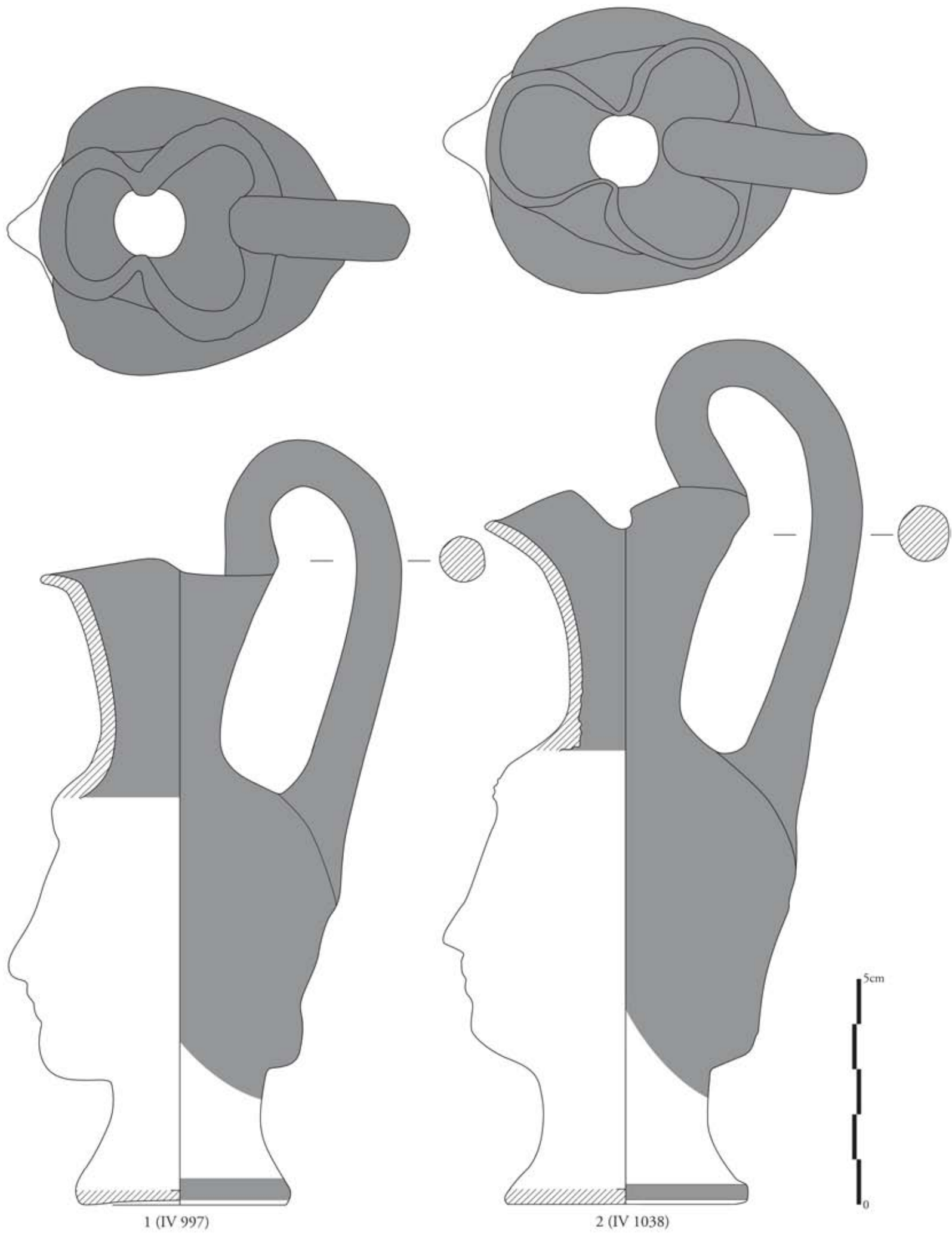



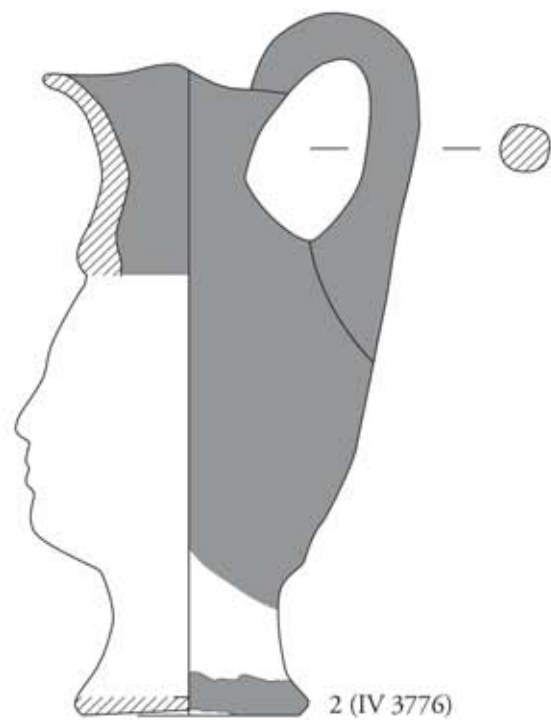
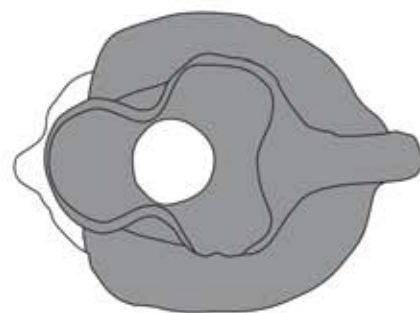
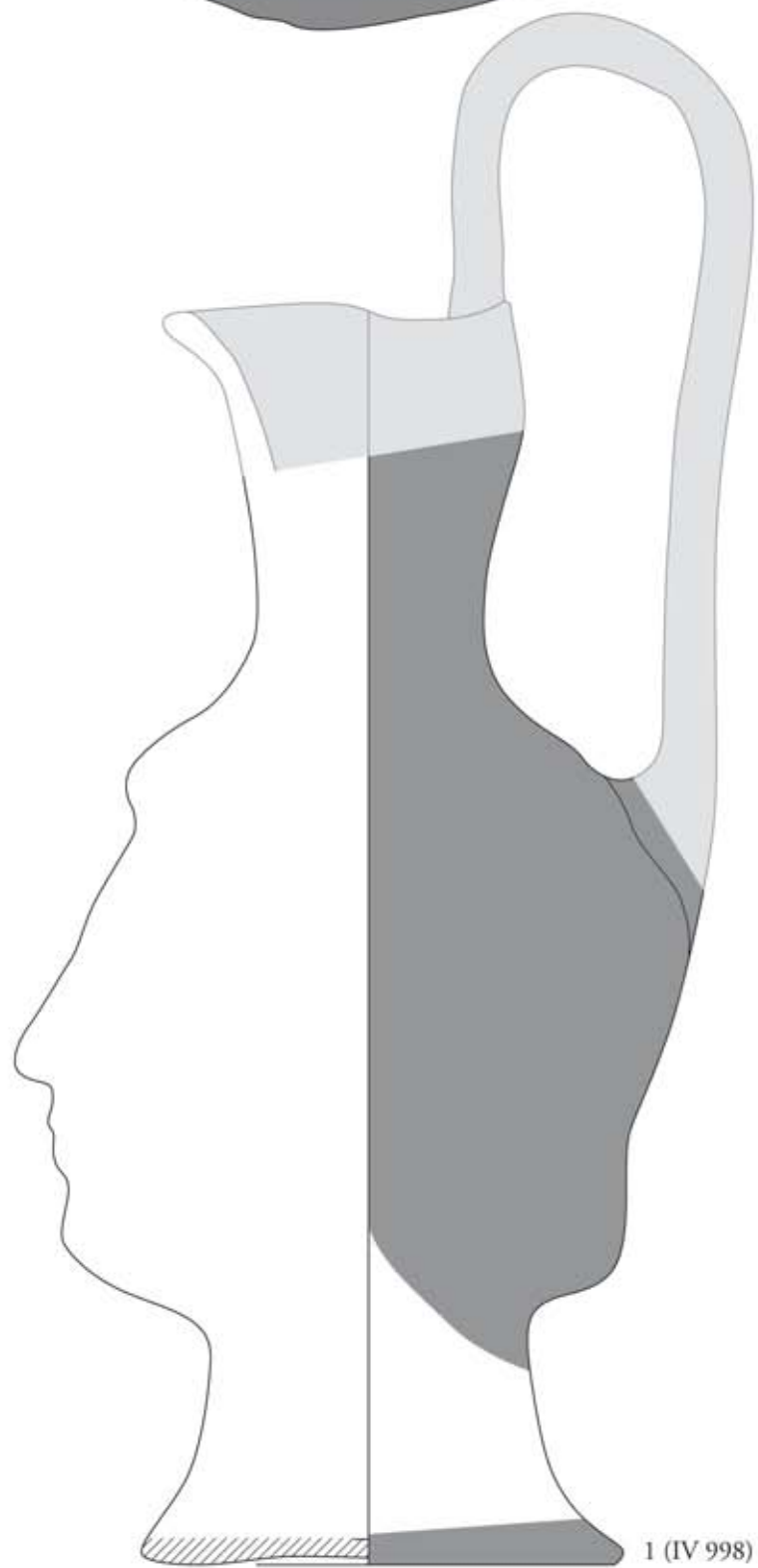
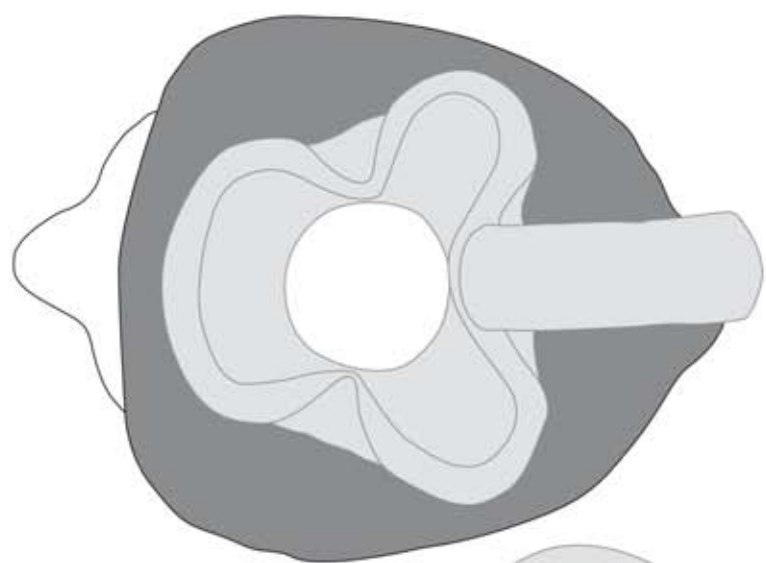

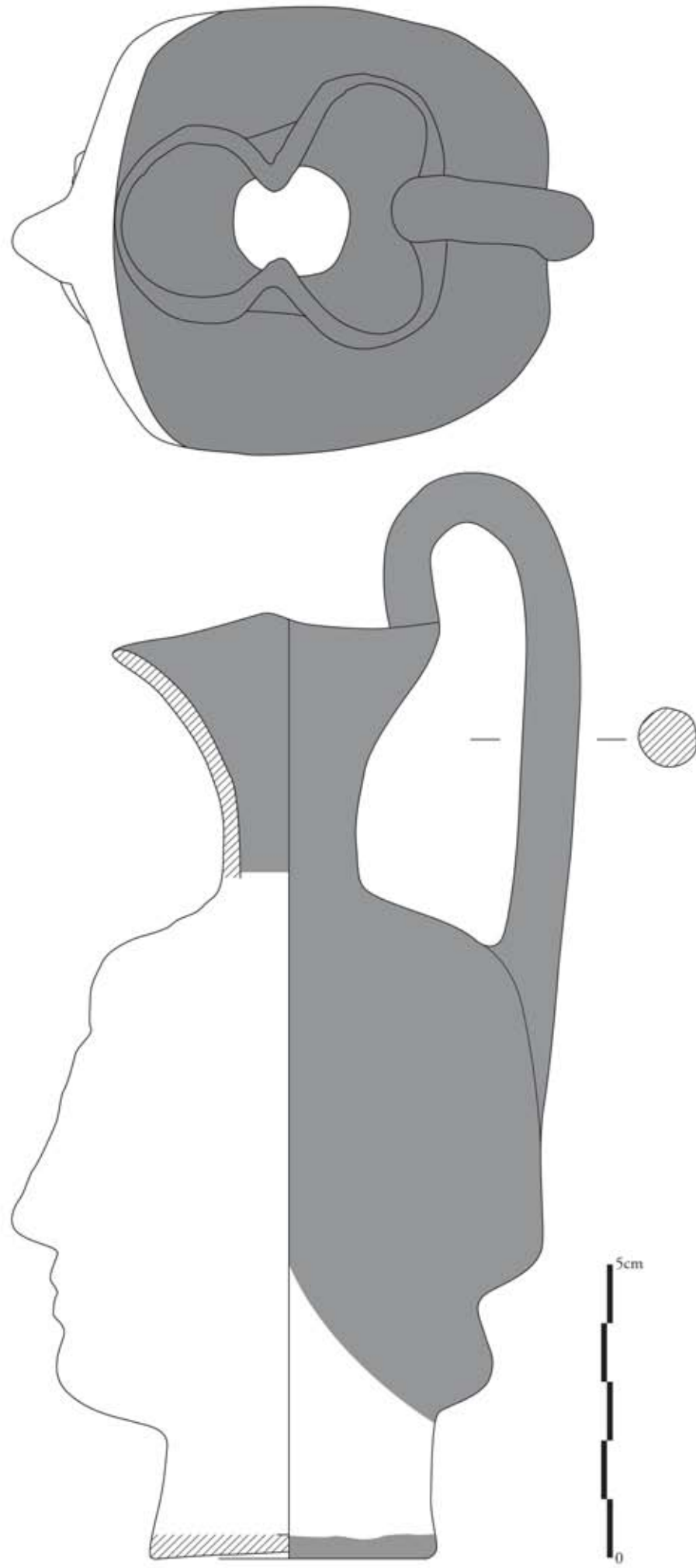

1 (IV 999)

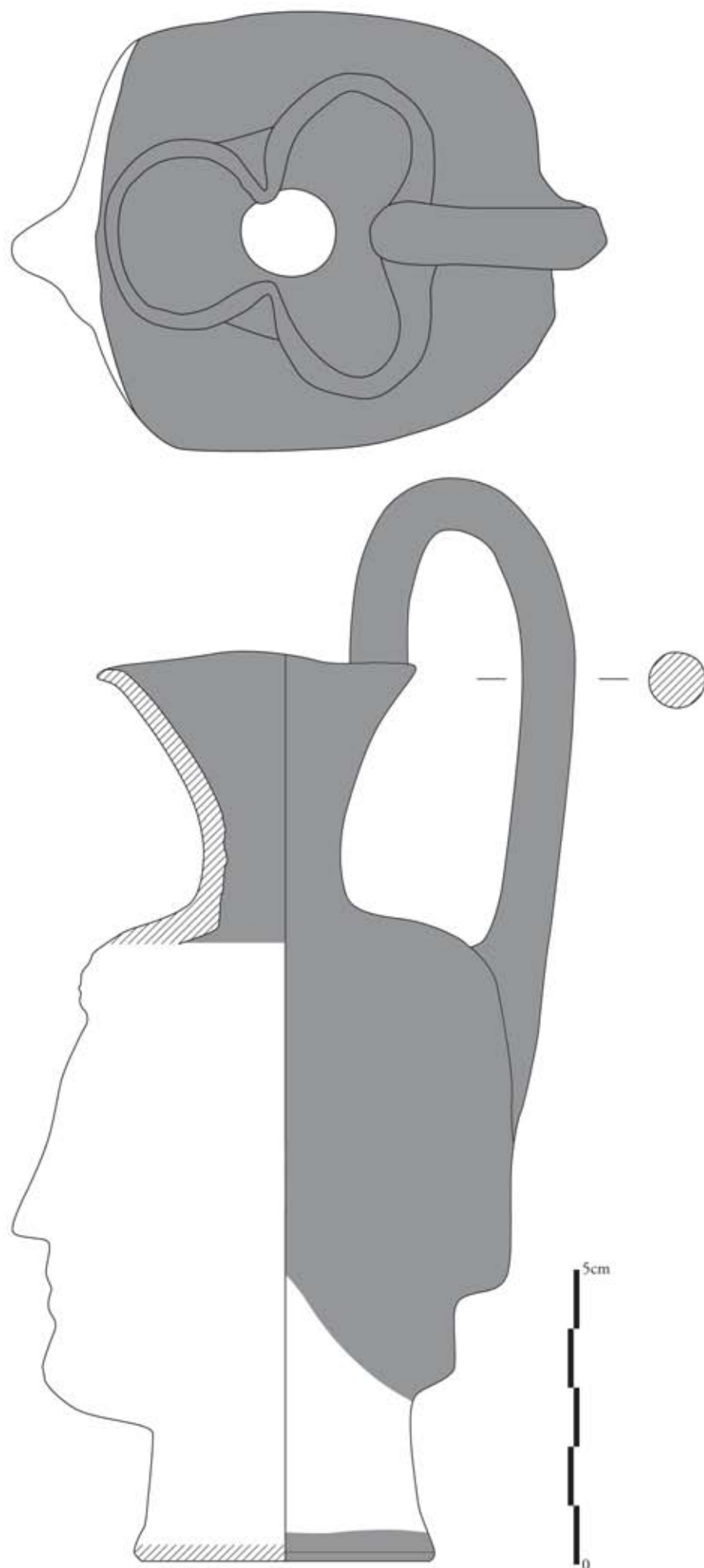

1 (IV 1039)

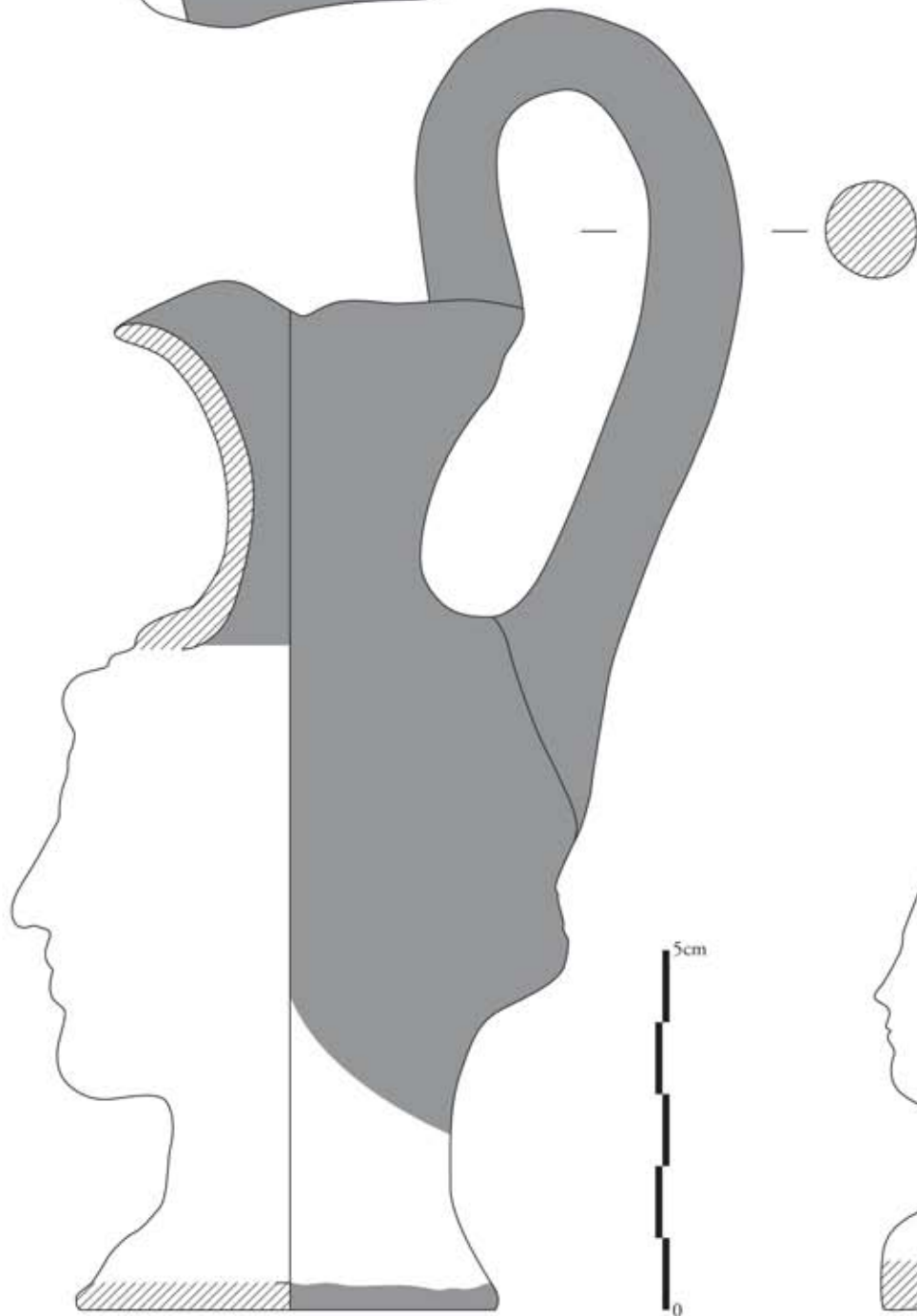
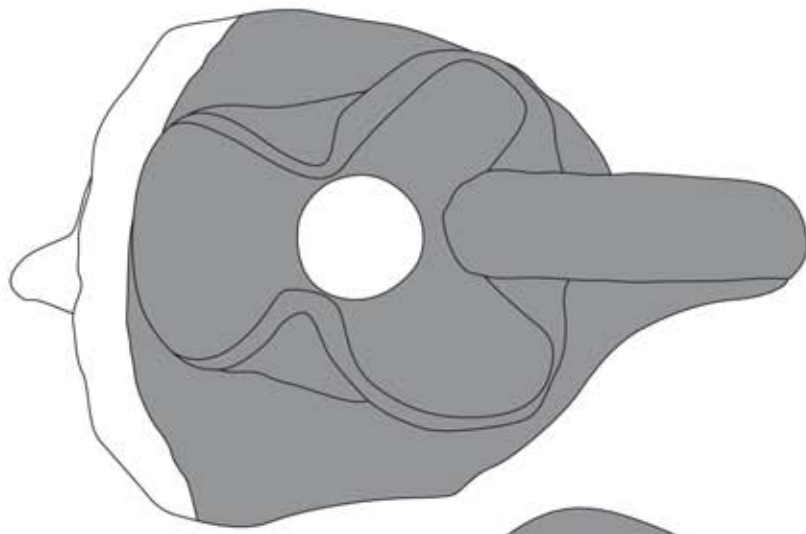

1 (IV 1000)

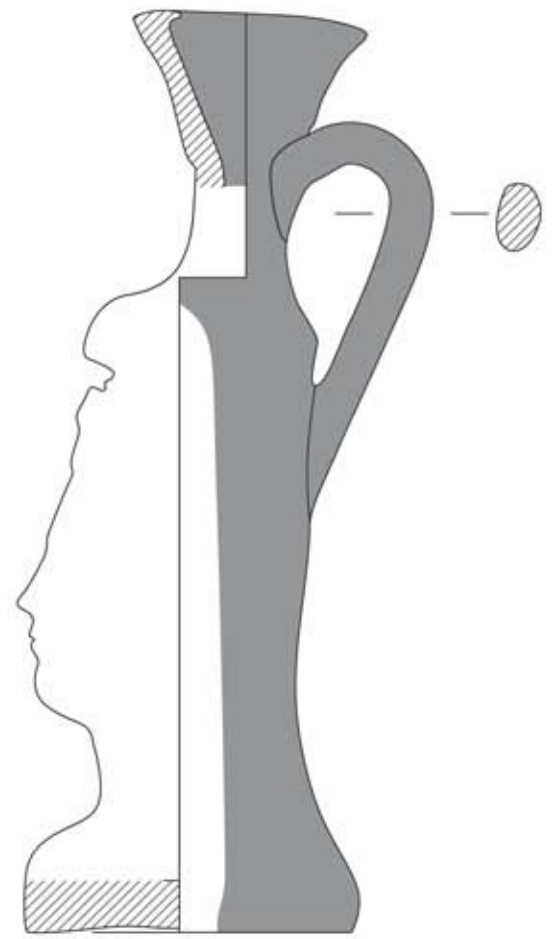

2 (IV 3777)

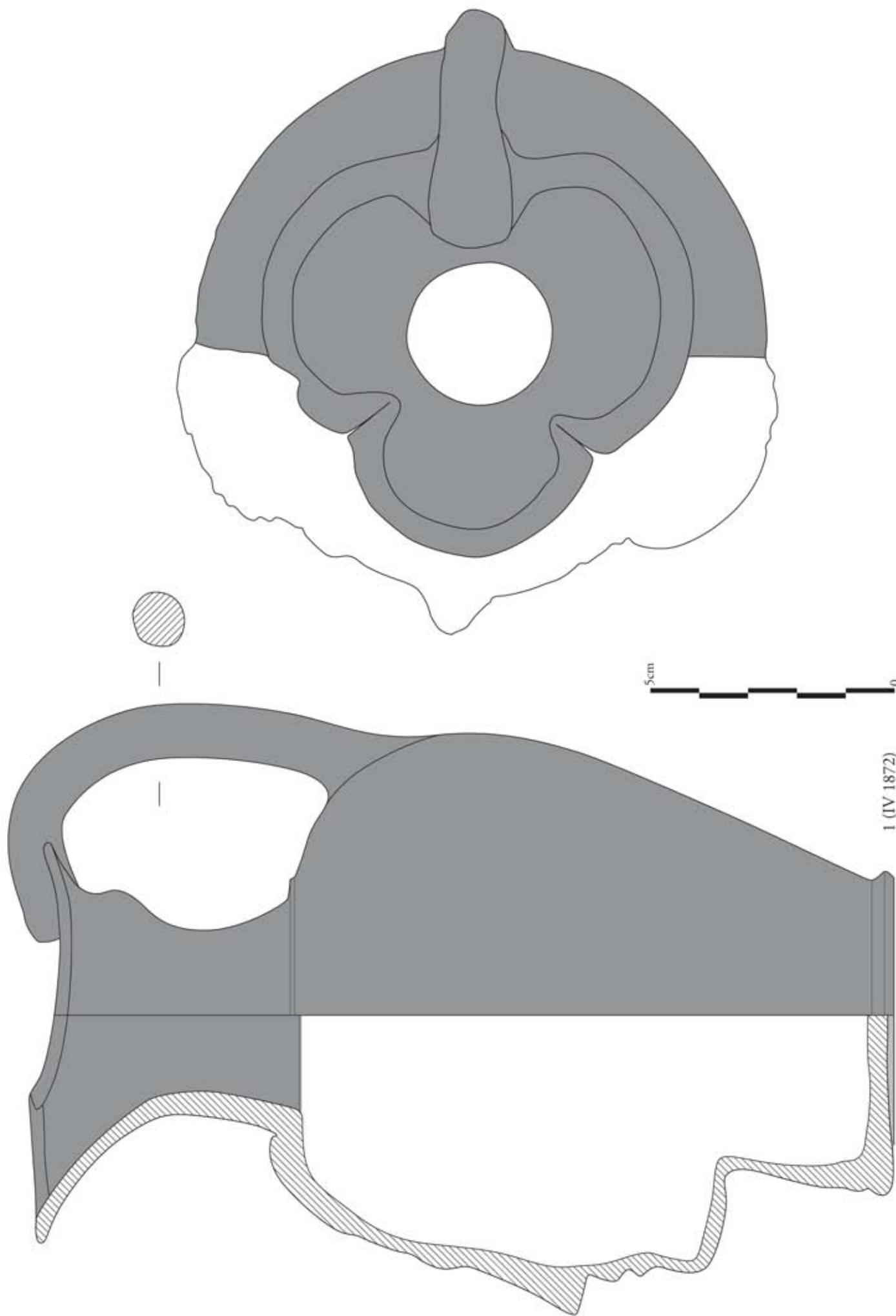

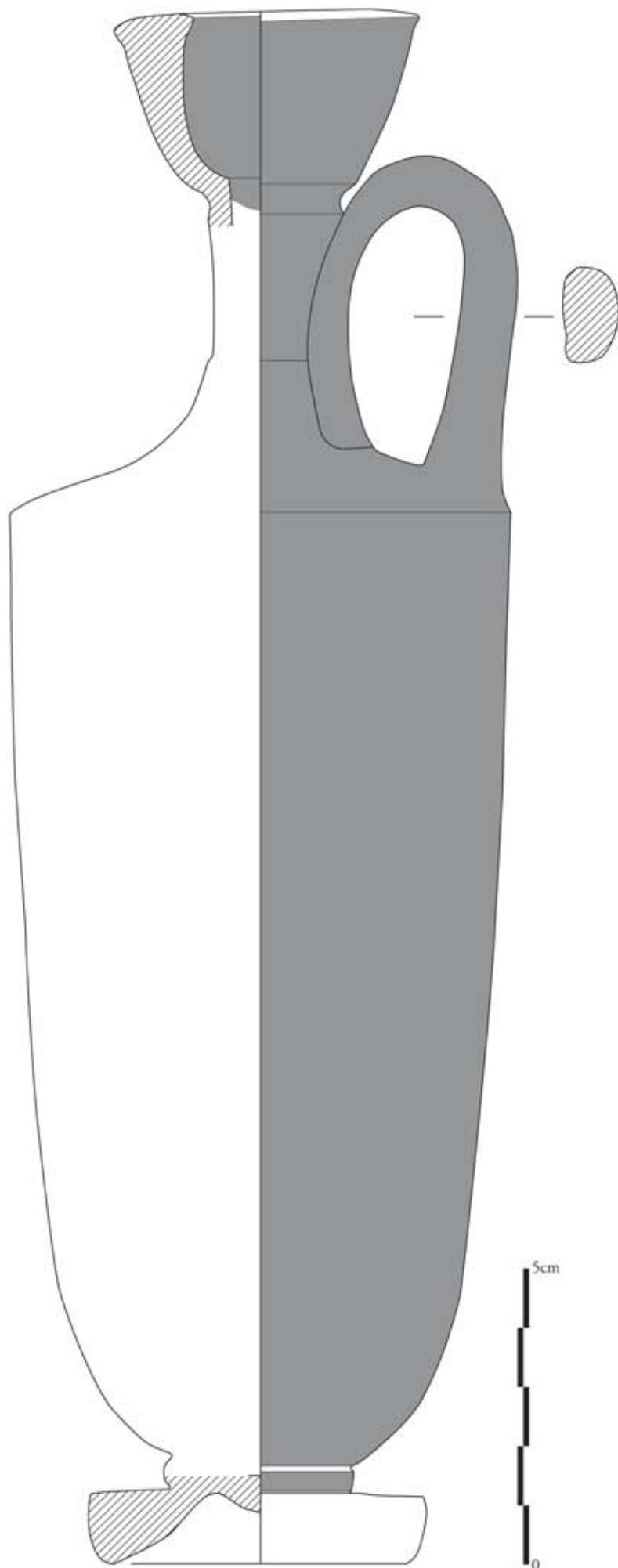

1 (IV 699)

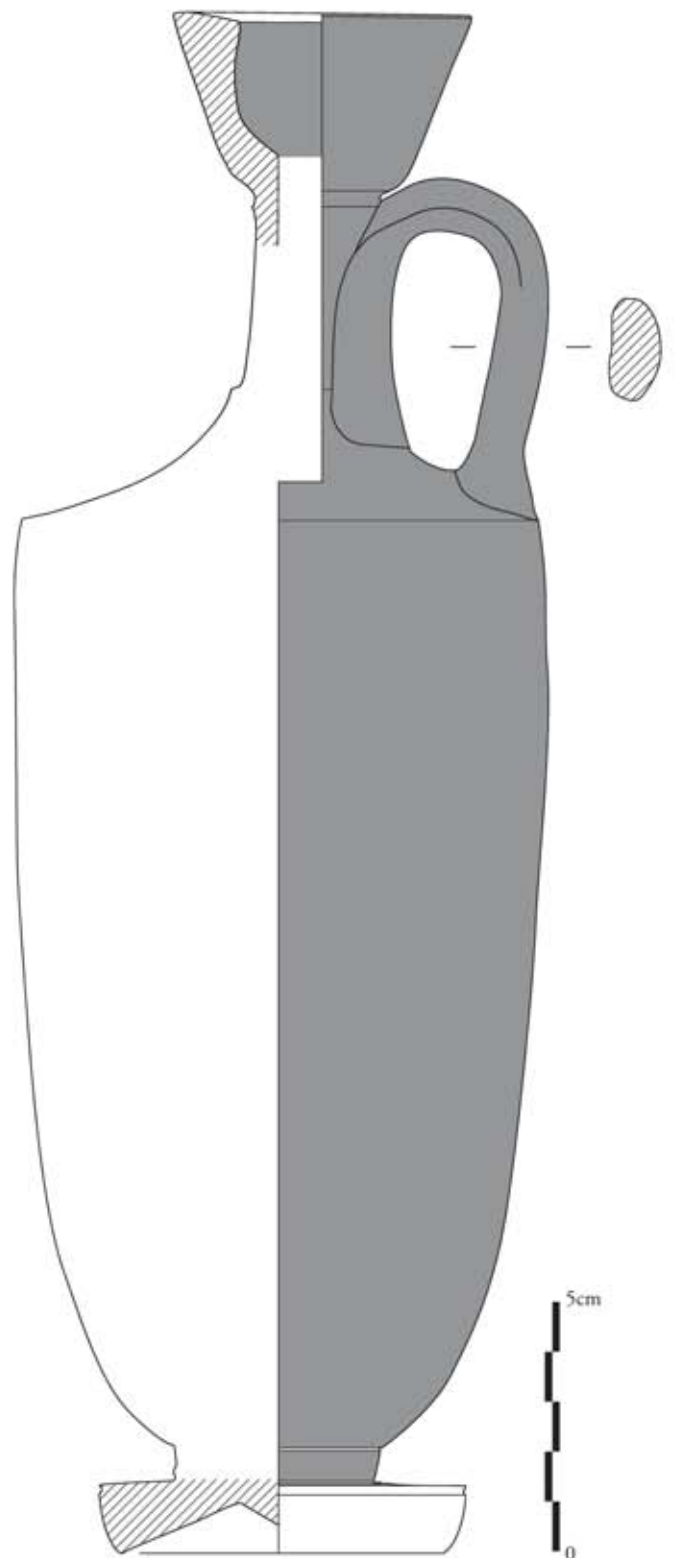

2 (IV 747)

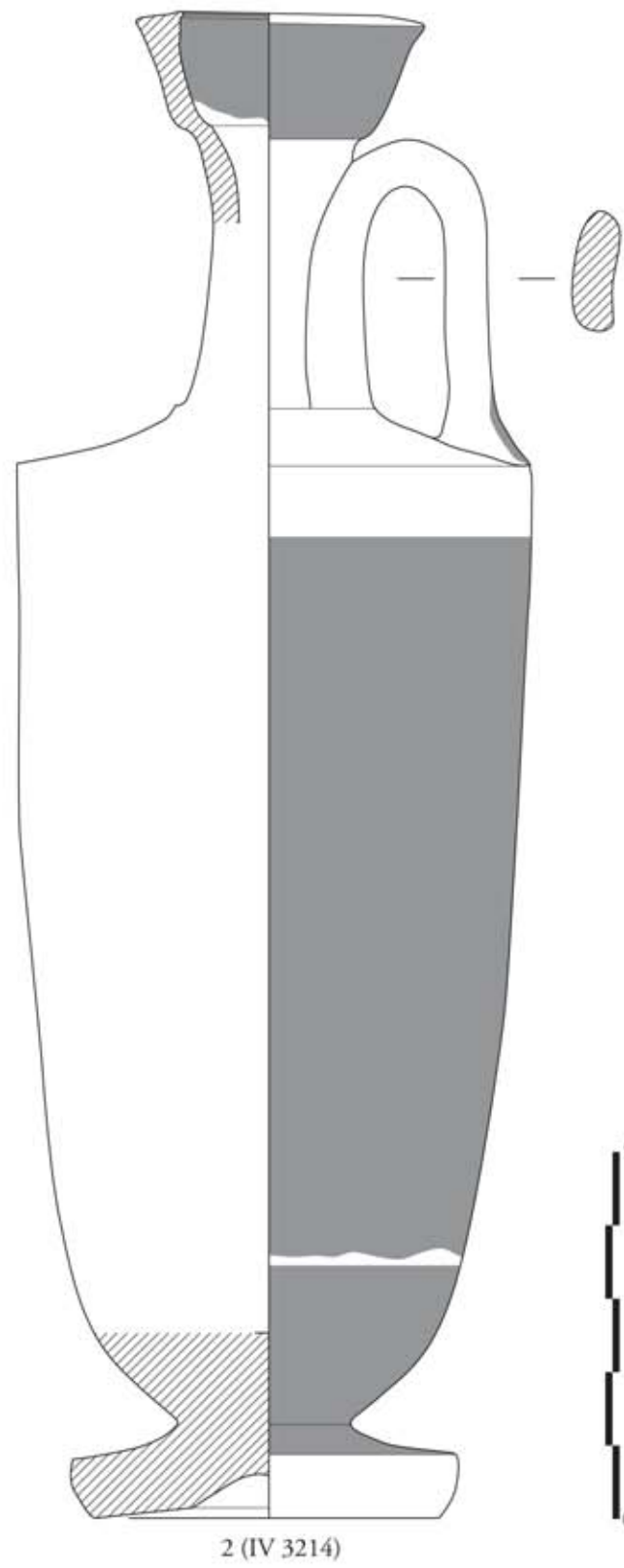
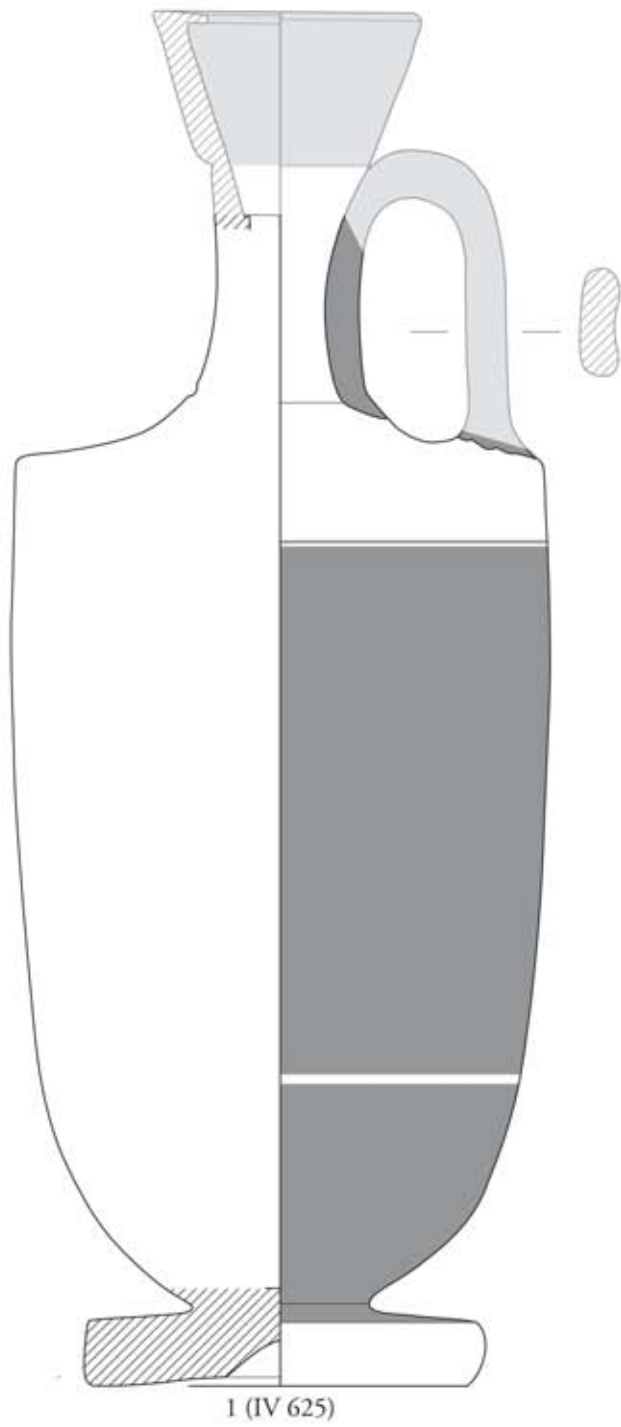

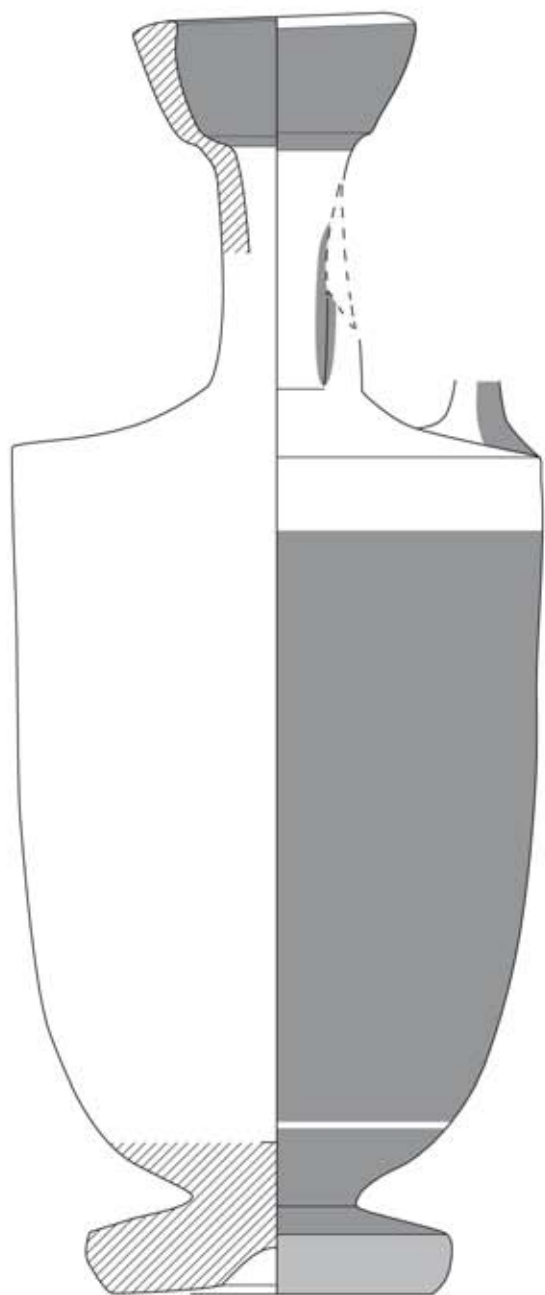

1 (IV 874)

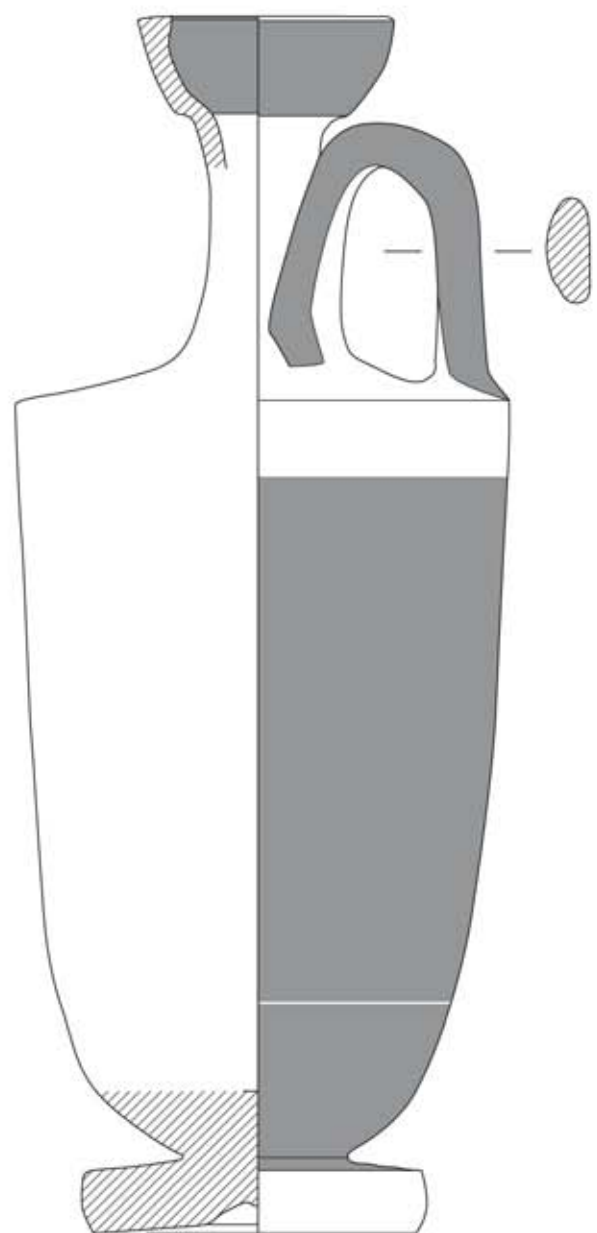

2 (IV 3209)

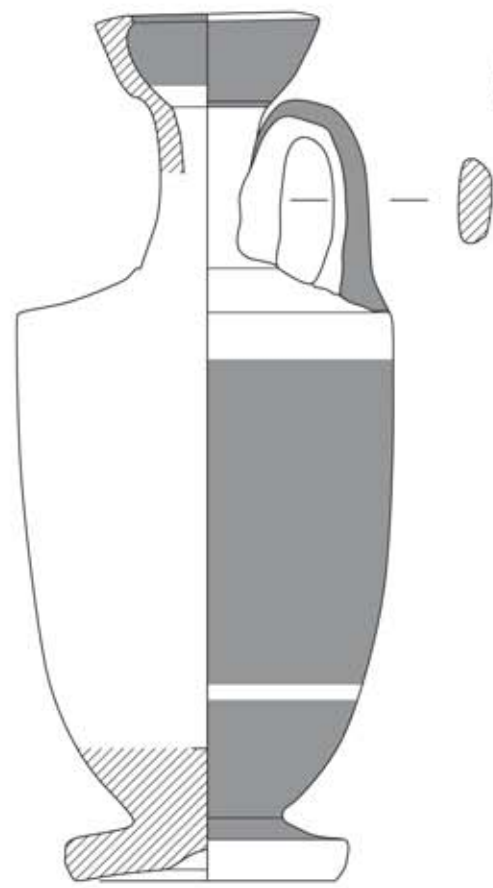

3 (IV 803)





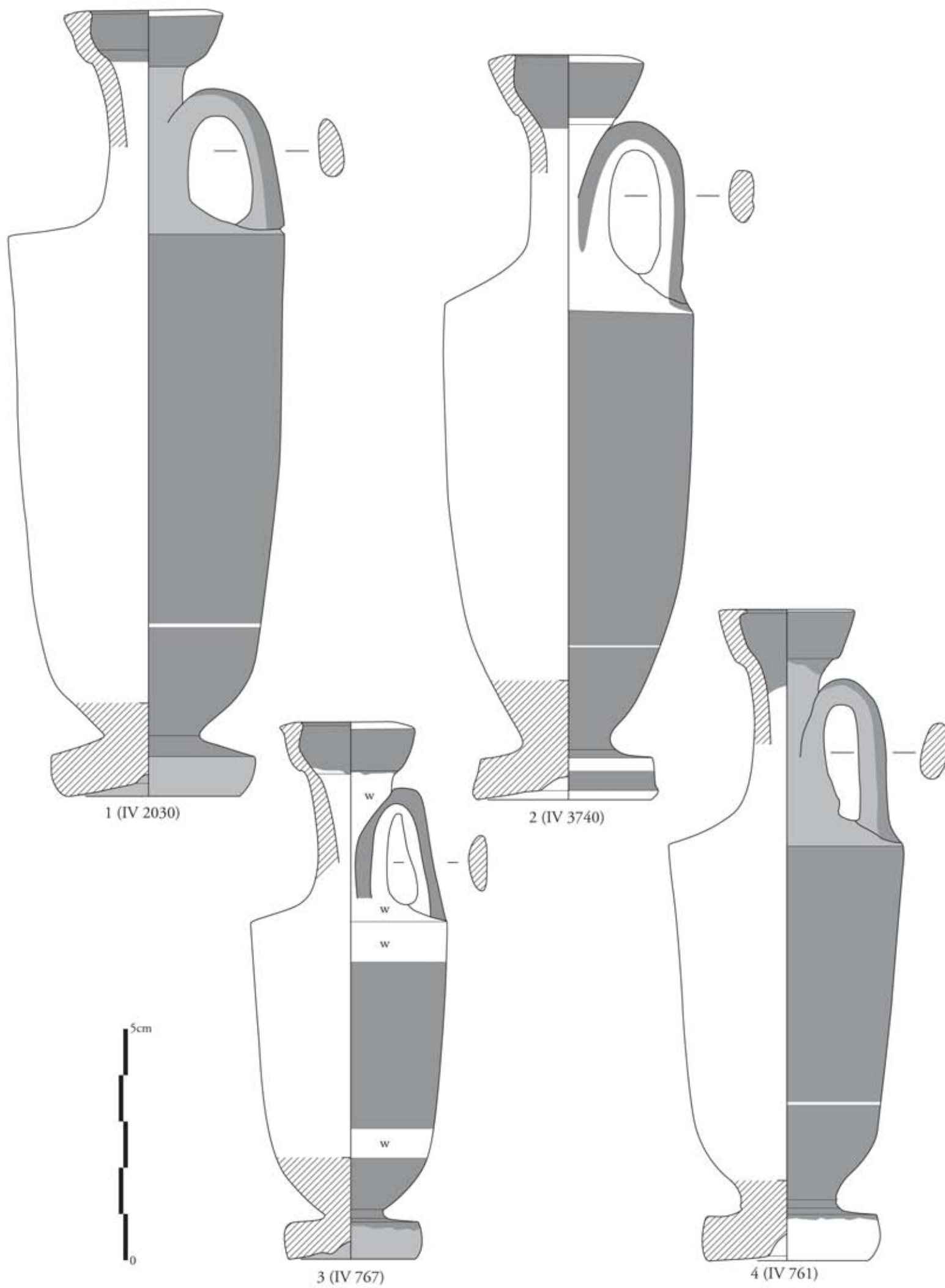

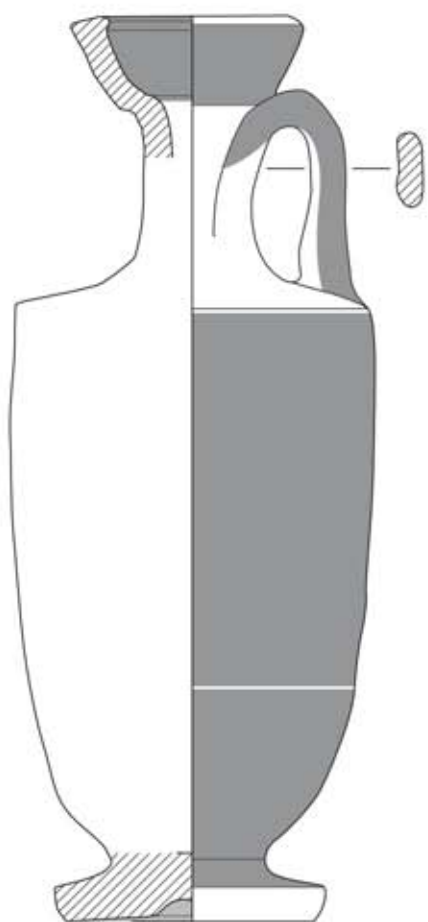

1 (IV 676)

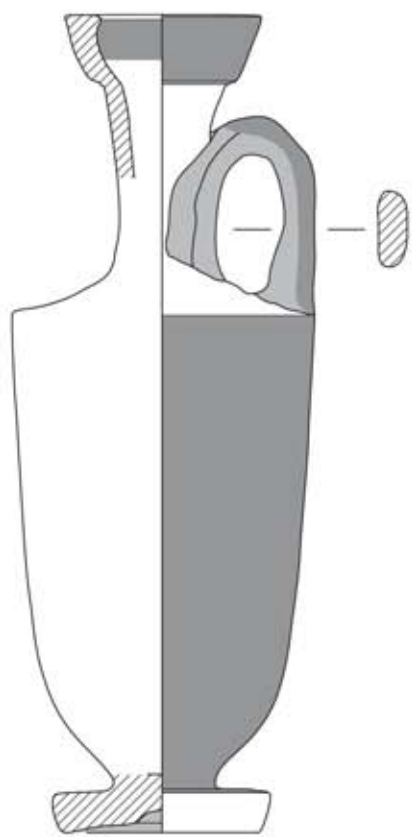

3 (IV 637)

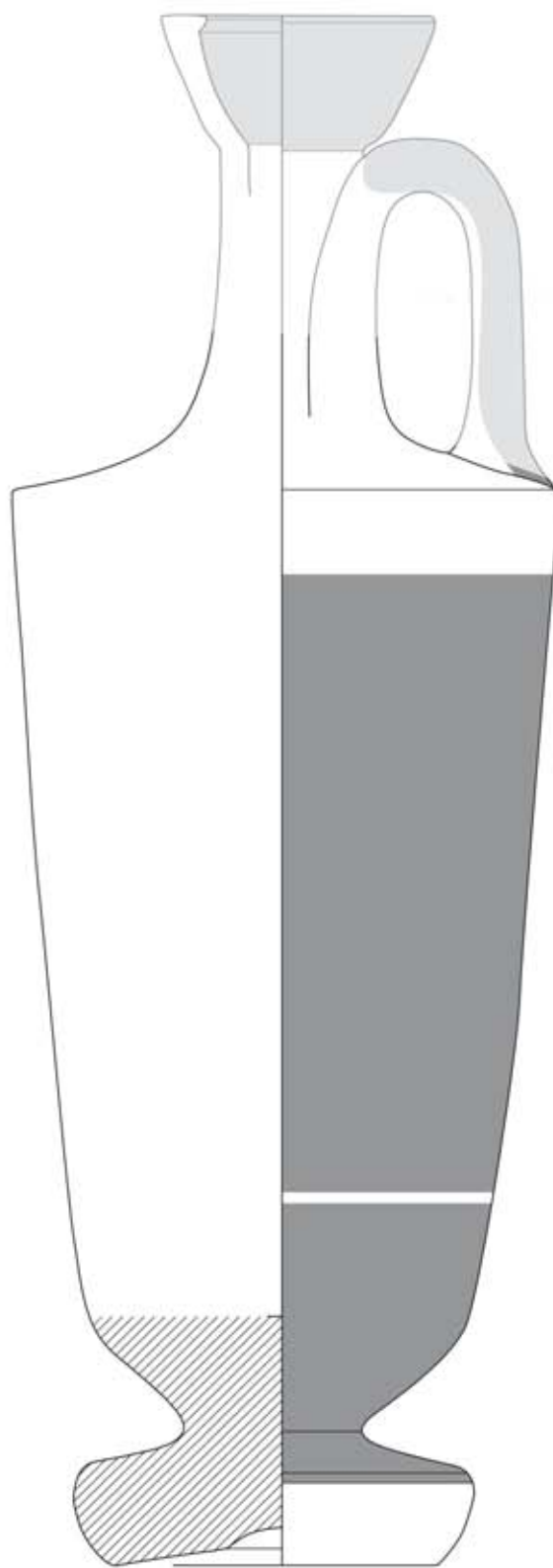

2 (IV 718)

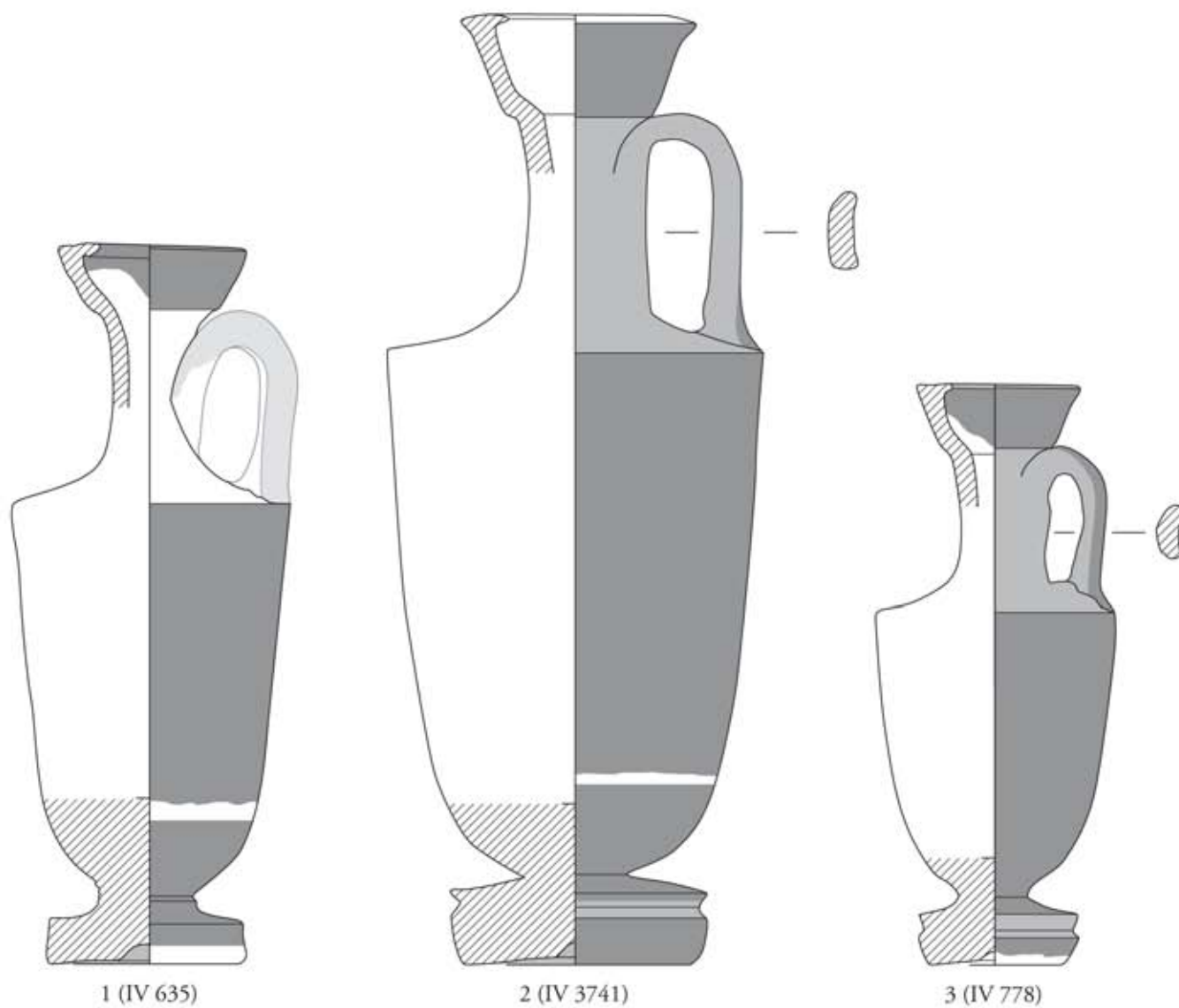

0 5cm

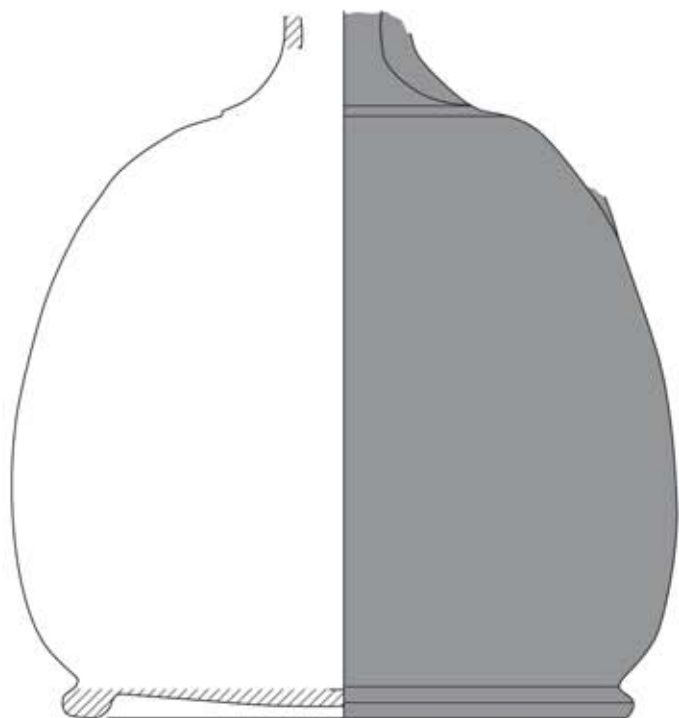

1 (IV 2031)

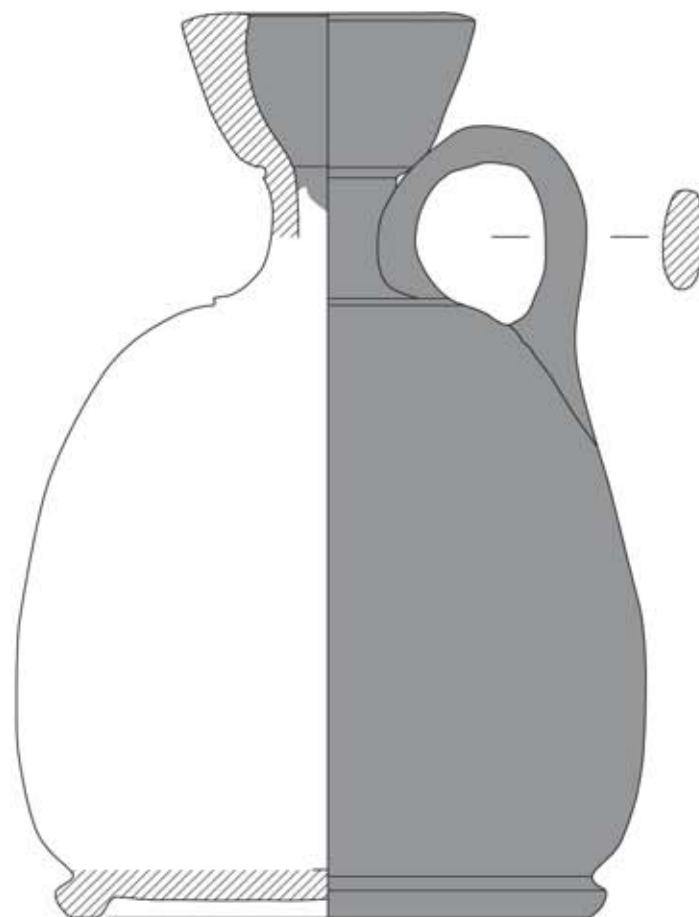

2 (IV 3757)

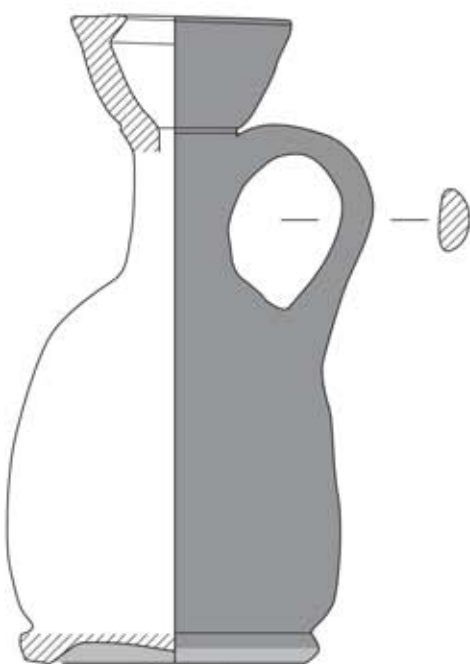

3 (IV 1020)

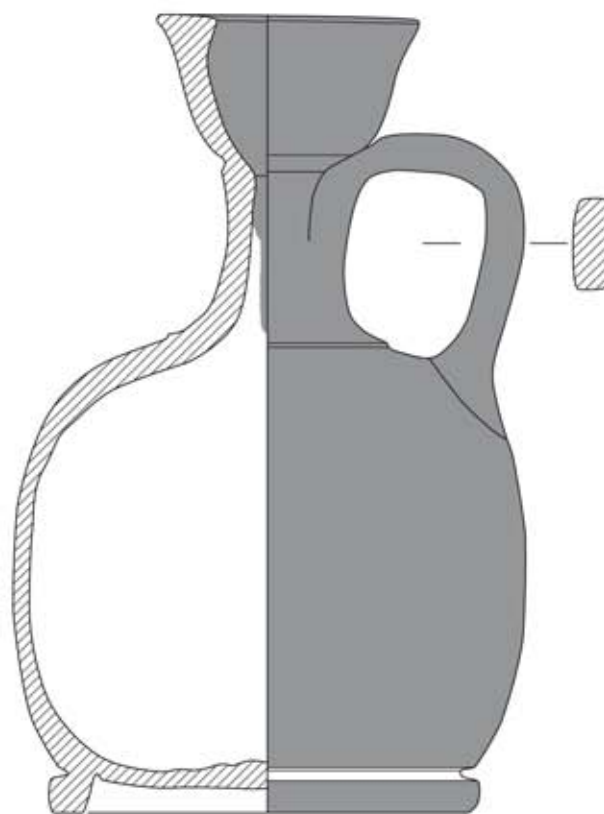

4 (IV 1630)

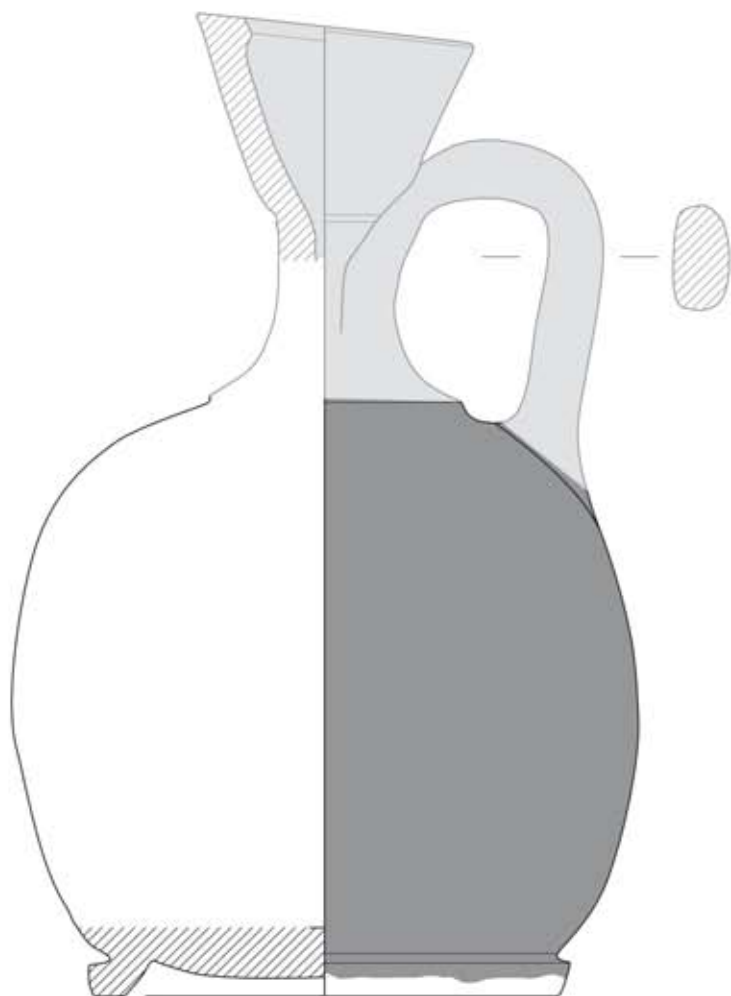

1 (IV 912)

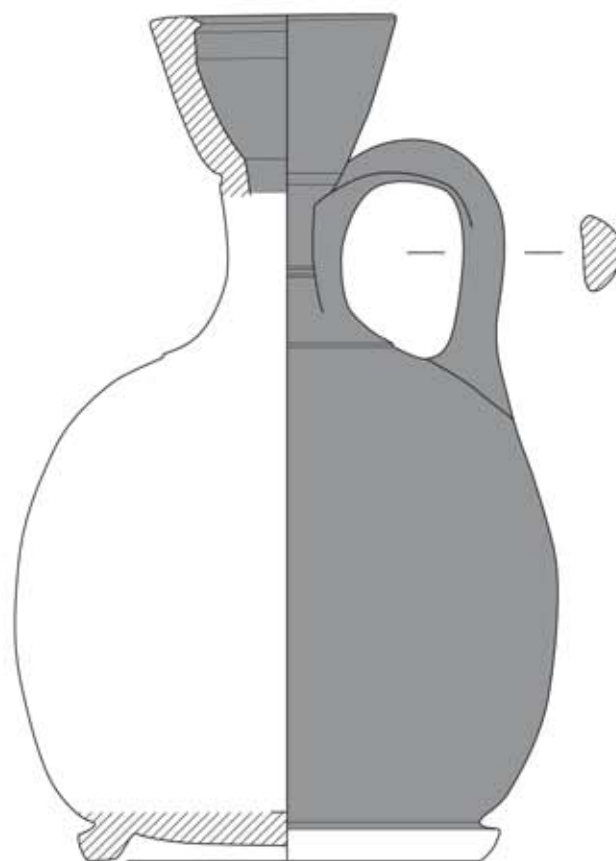

2 (IV 1100)

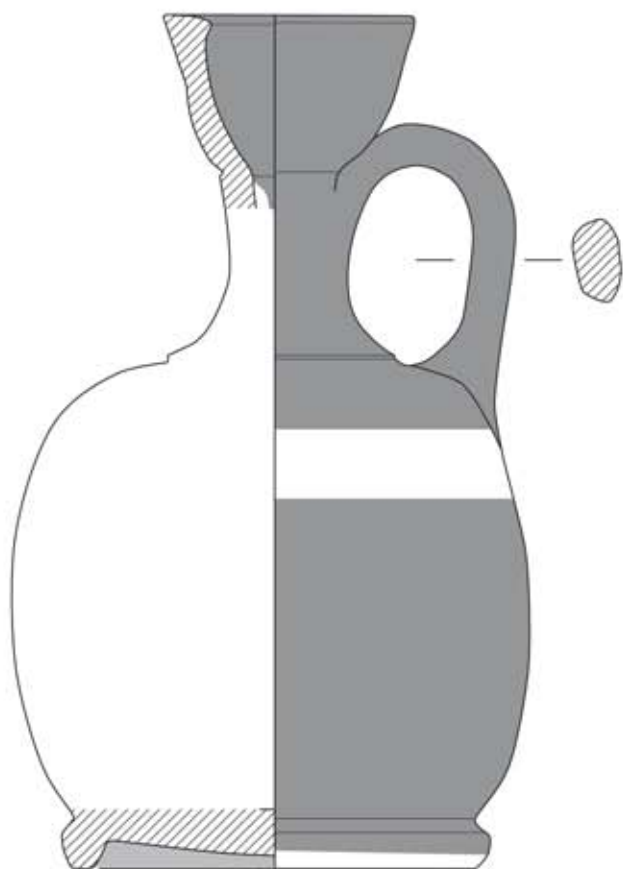

3 (IV 3761)

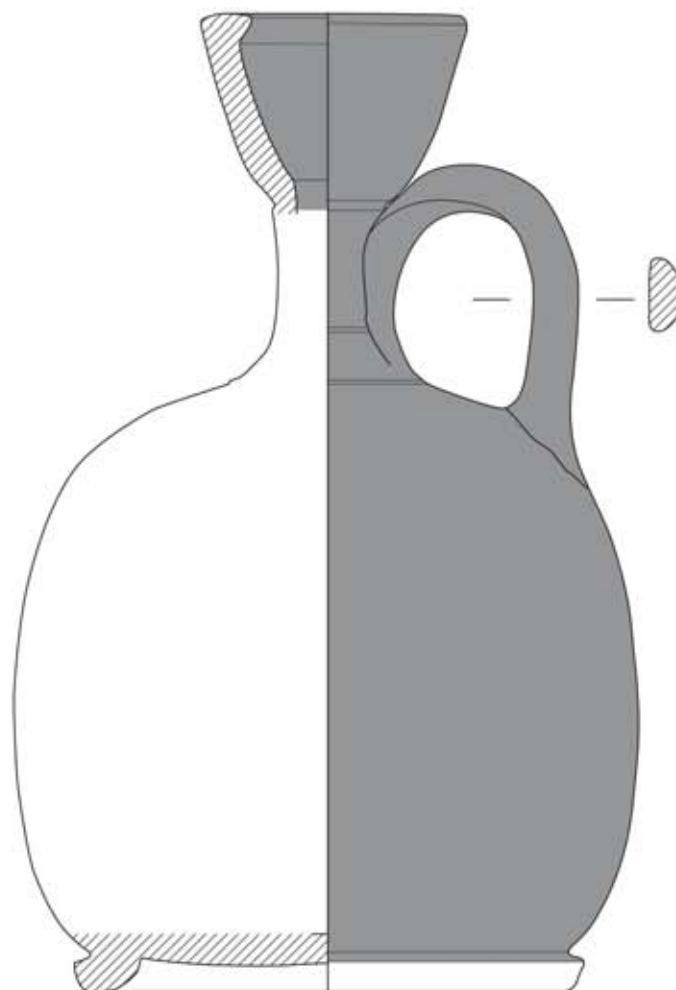

4 (IV 1146)

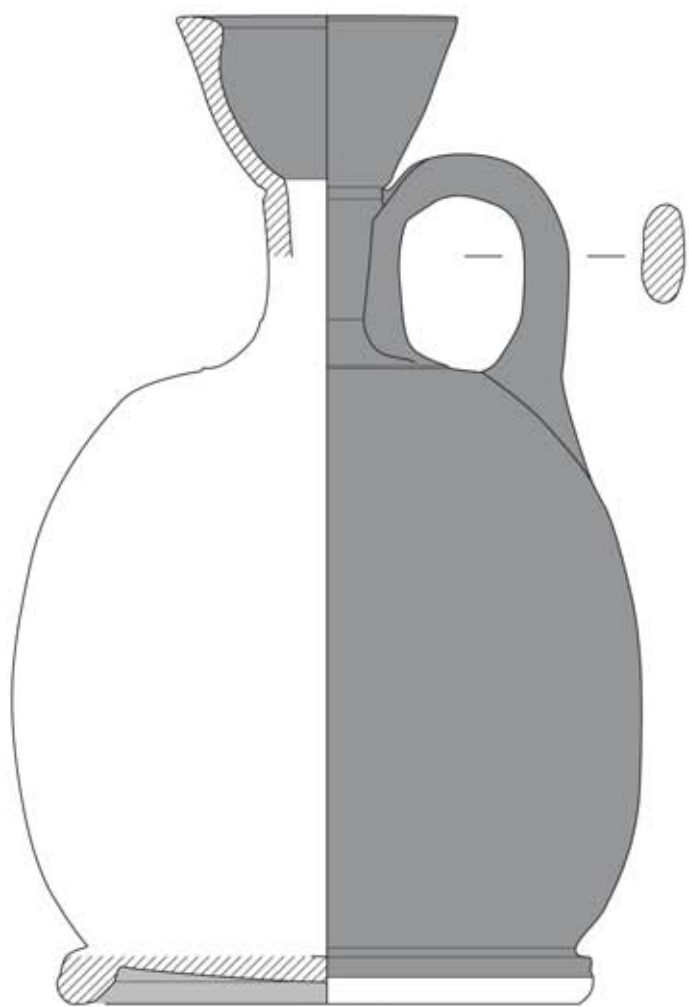

1 (IV 867)

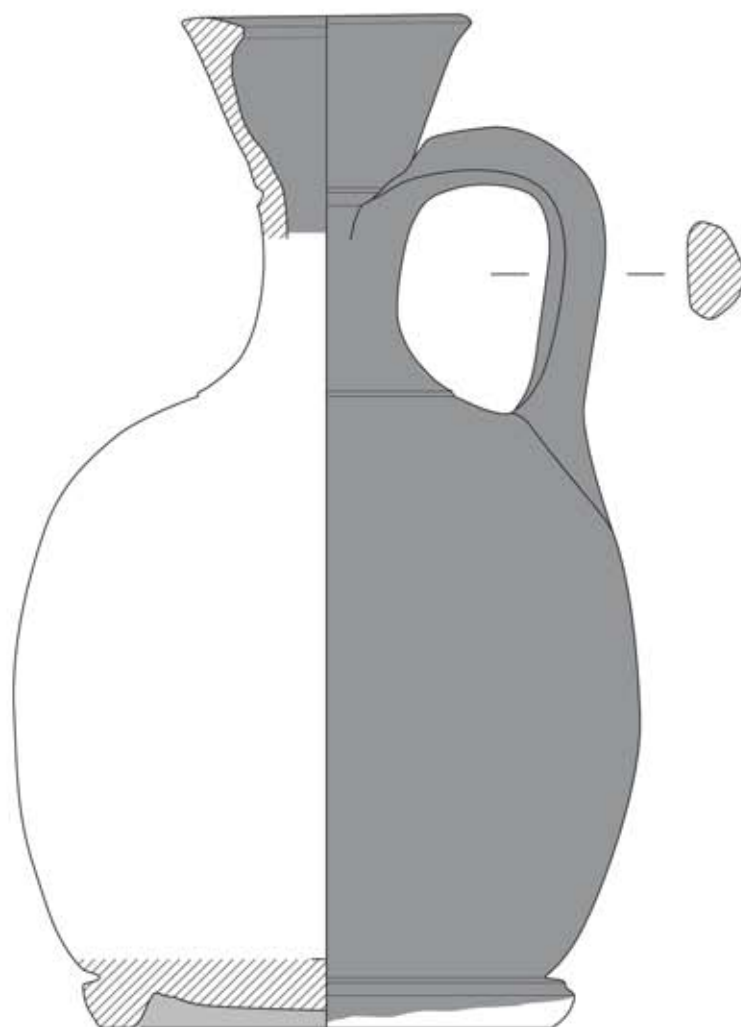

2 (IV 3756)

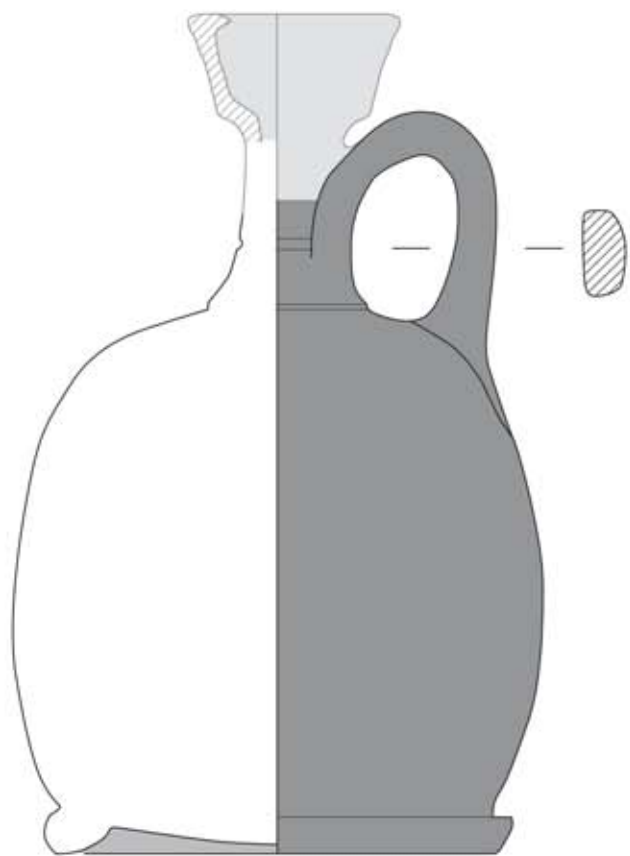

3 (IV 3759)

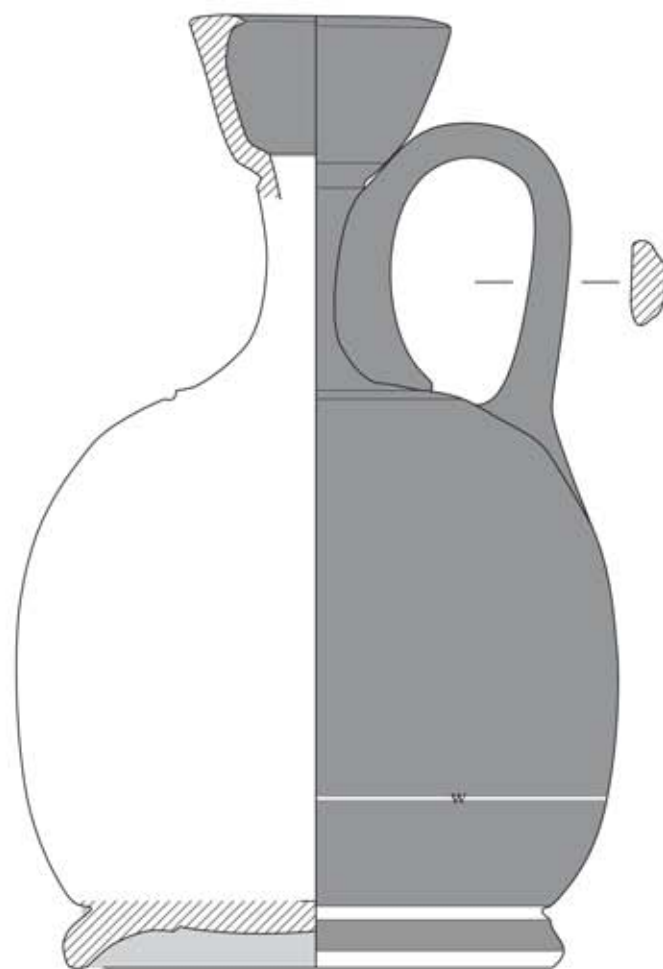

4 (IV 3751)

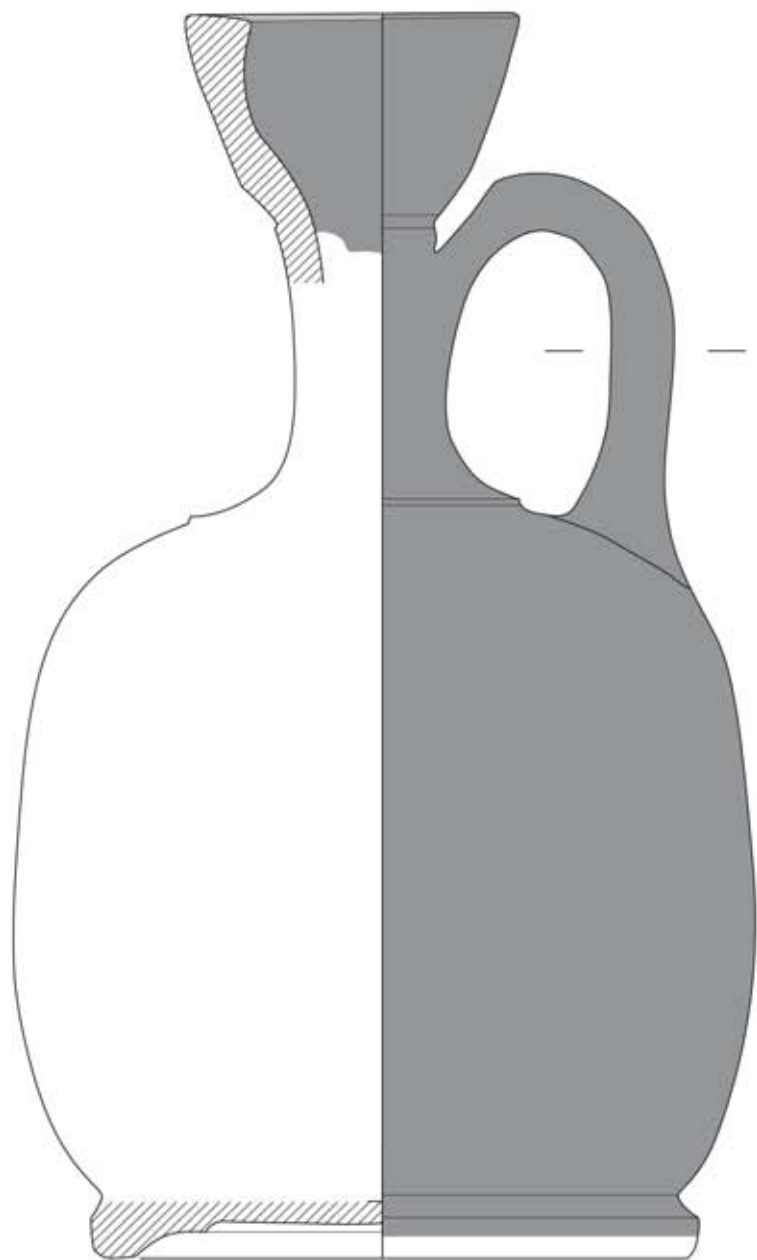

1 (IV 3764)

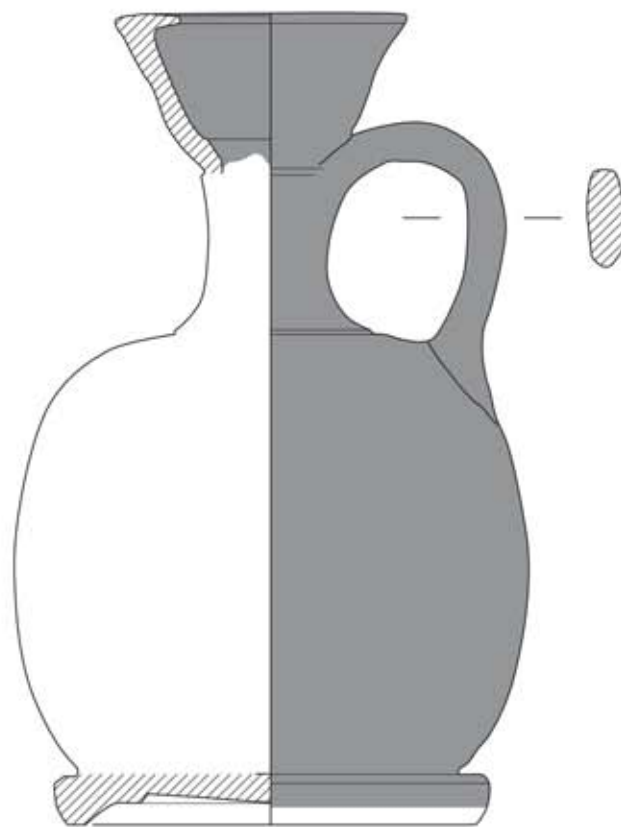

2 (IV 1060)

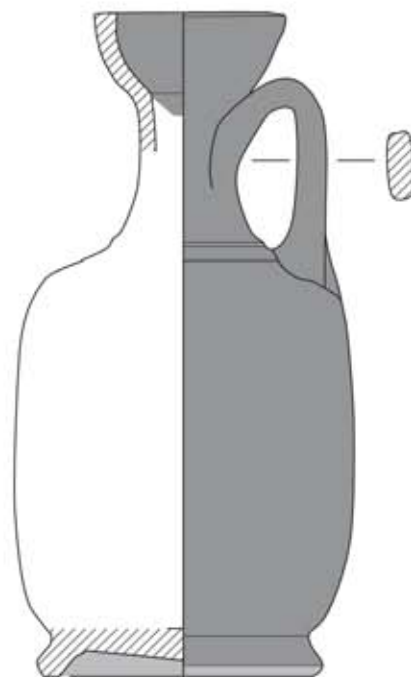

3 (IV 3753)



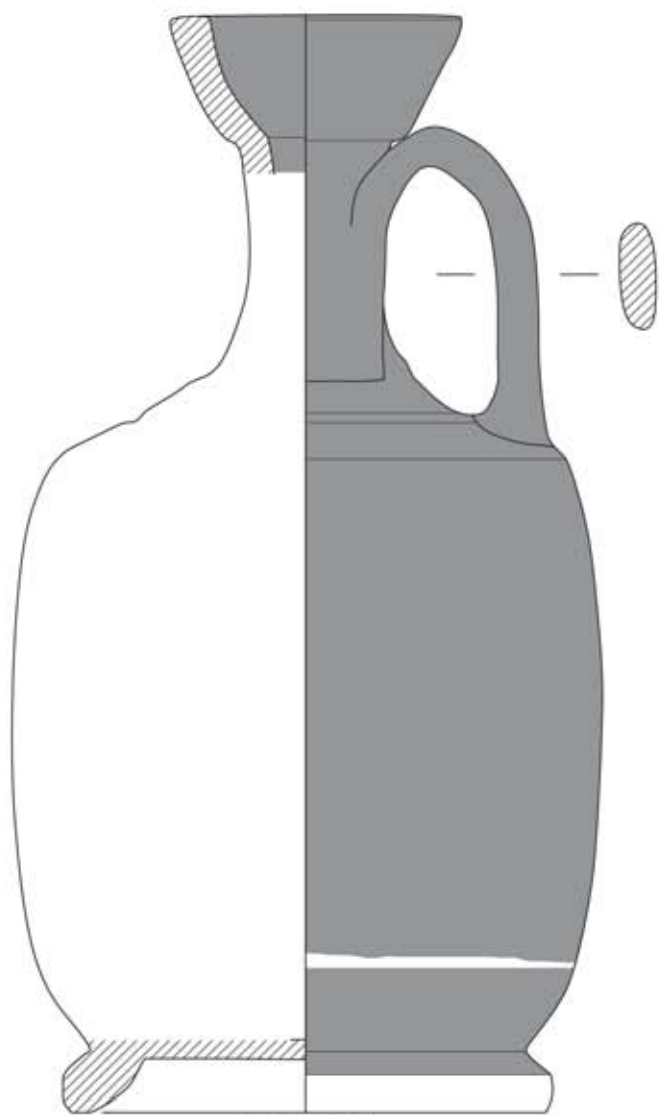

1 (IV 3755)

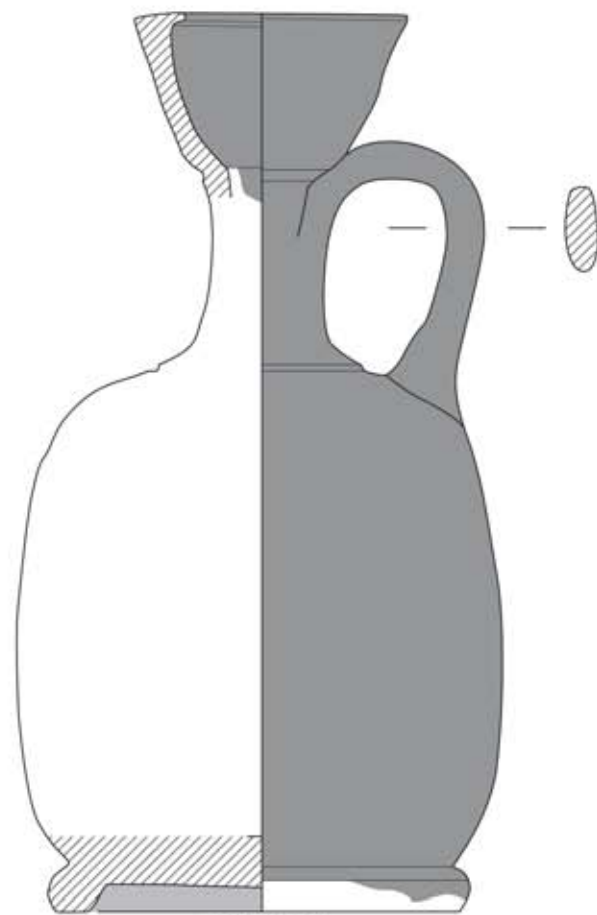

2 (IV 3762)

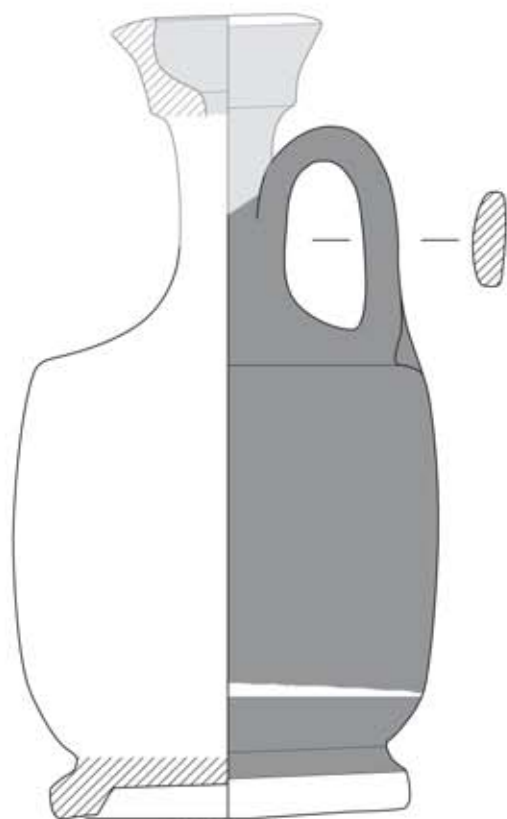

3 (IV 3754)

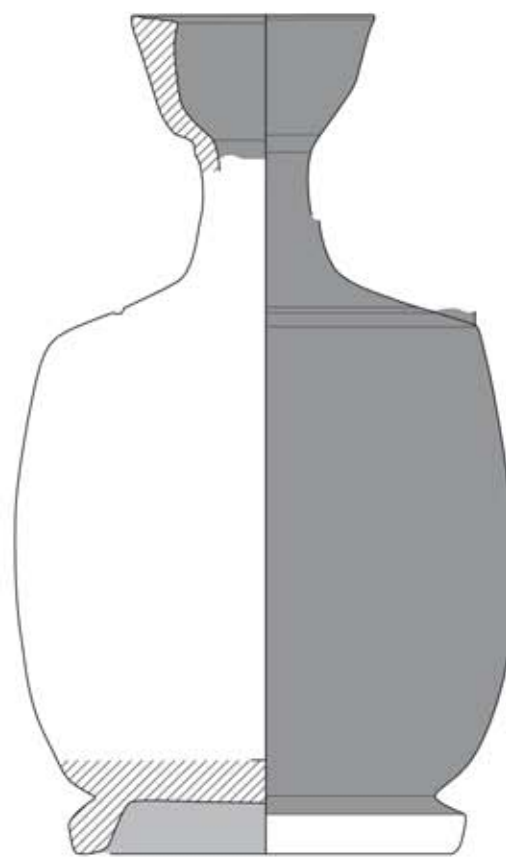

4 (IV 3758)



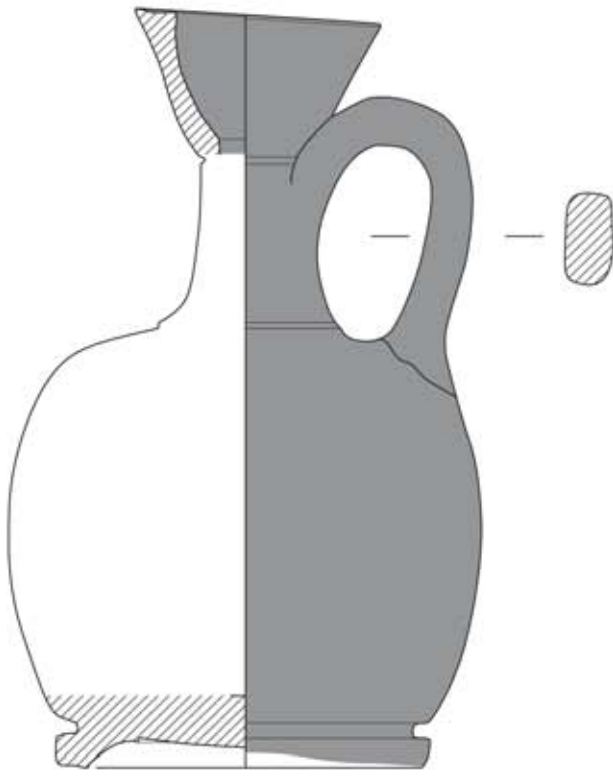

1 (IV 1631)

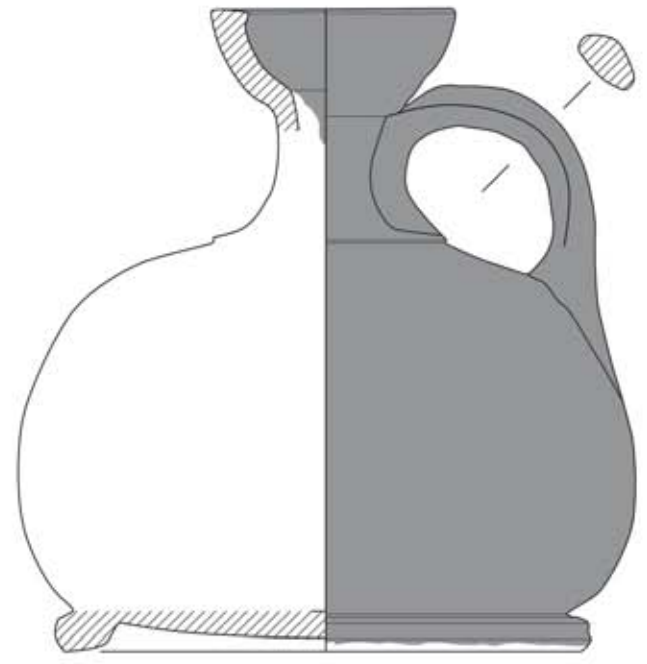

2 (IV 1921)

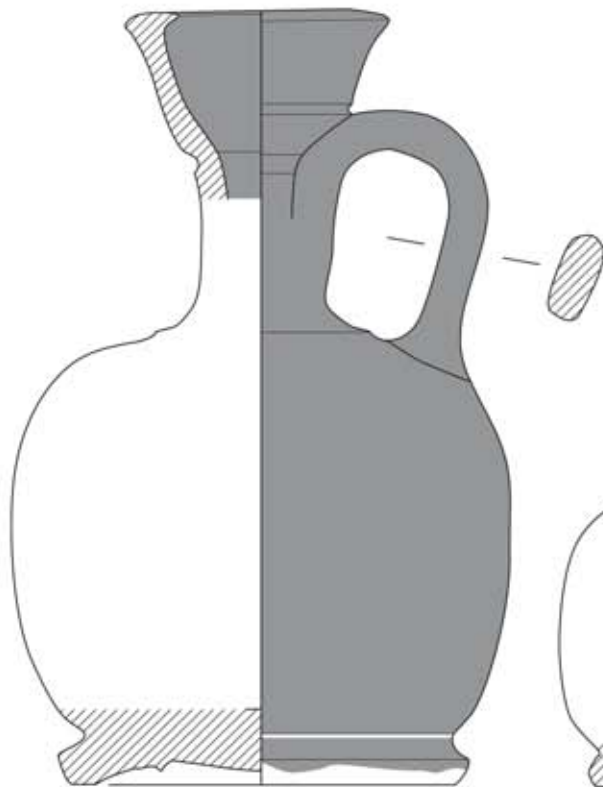

3 (IV 1785)

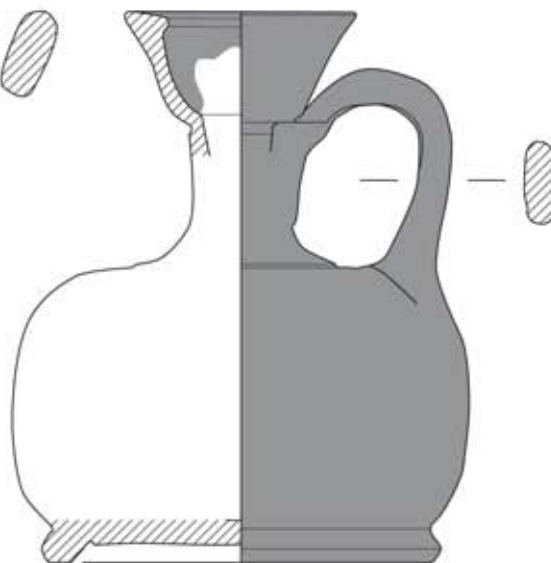

4 (IV 1938)

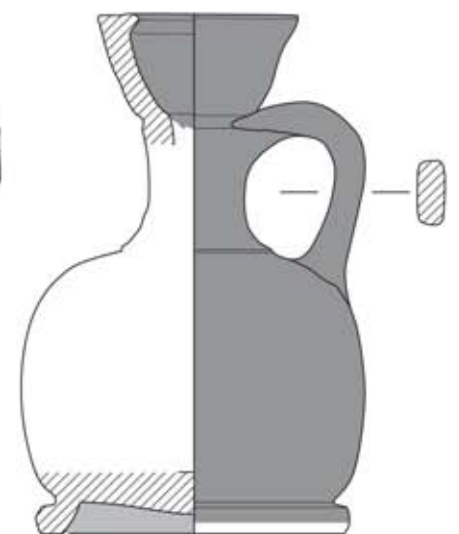

5 (IV 3763)

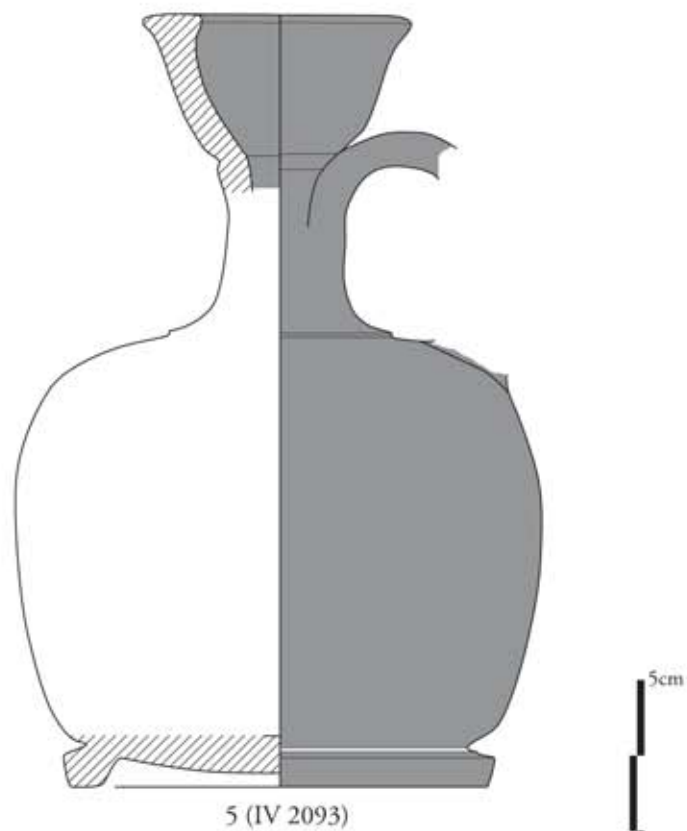
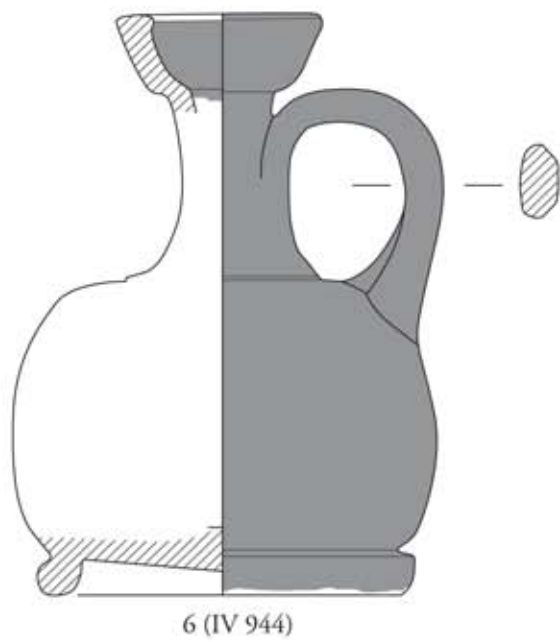
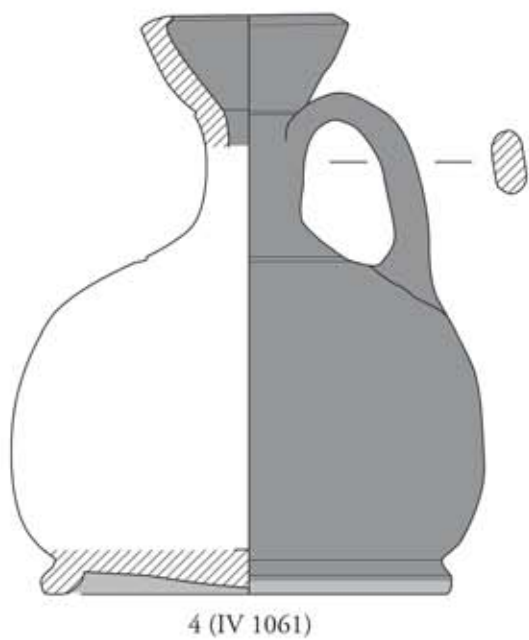
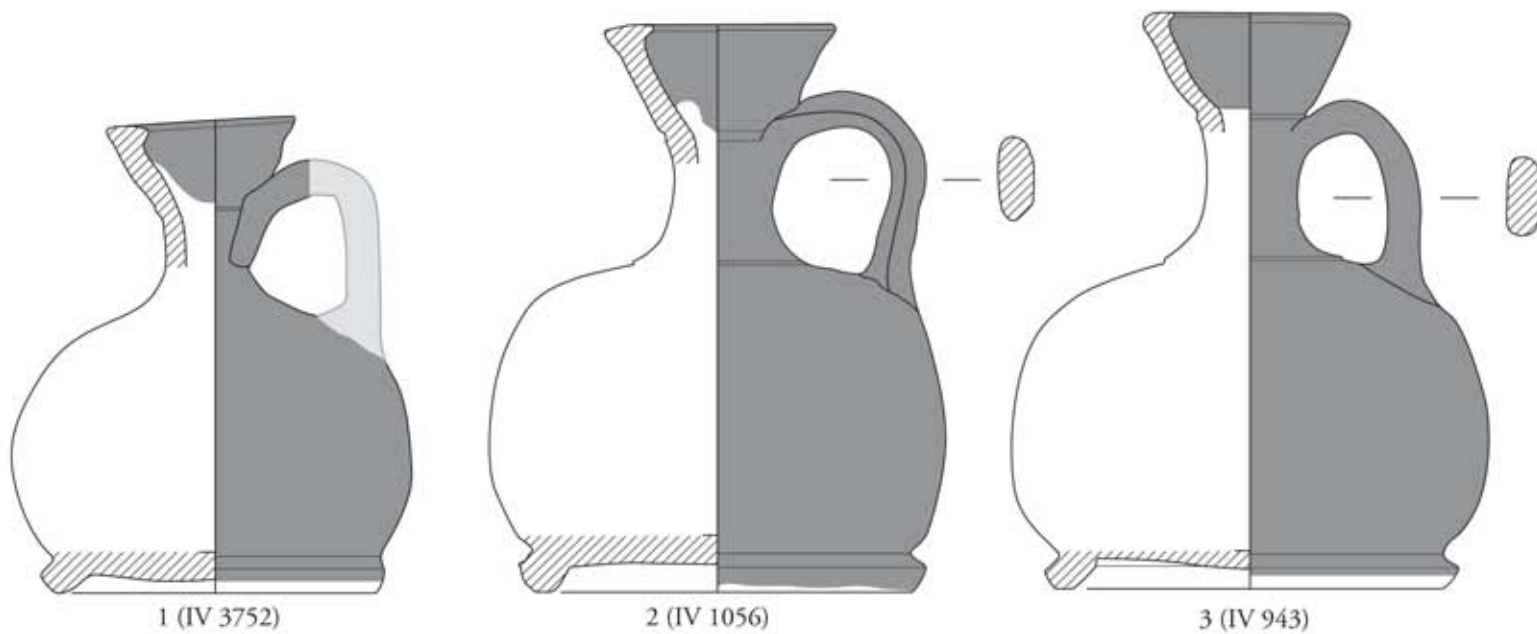

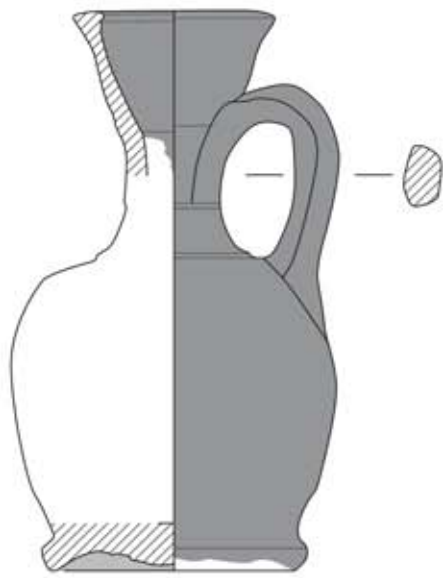

1 (IV 3760)

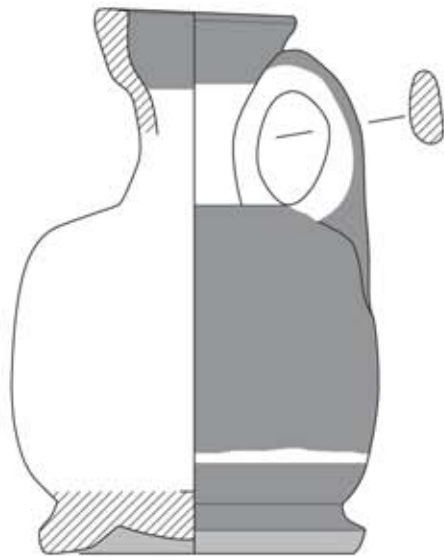

2 (IV 1934)

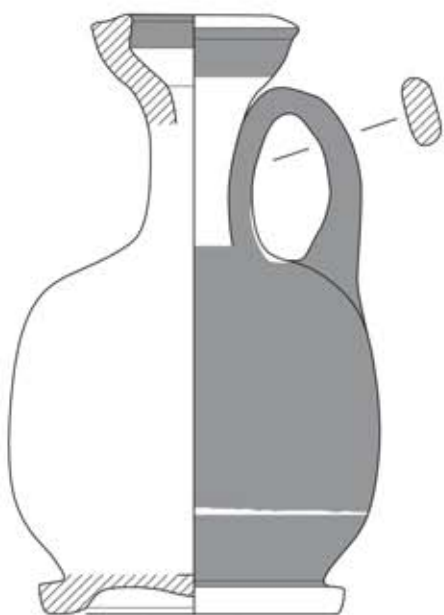

4 (IV 976)

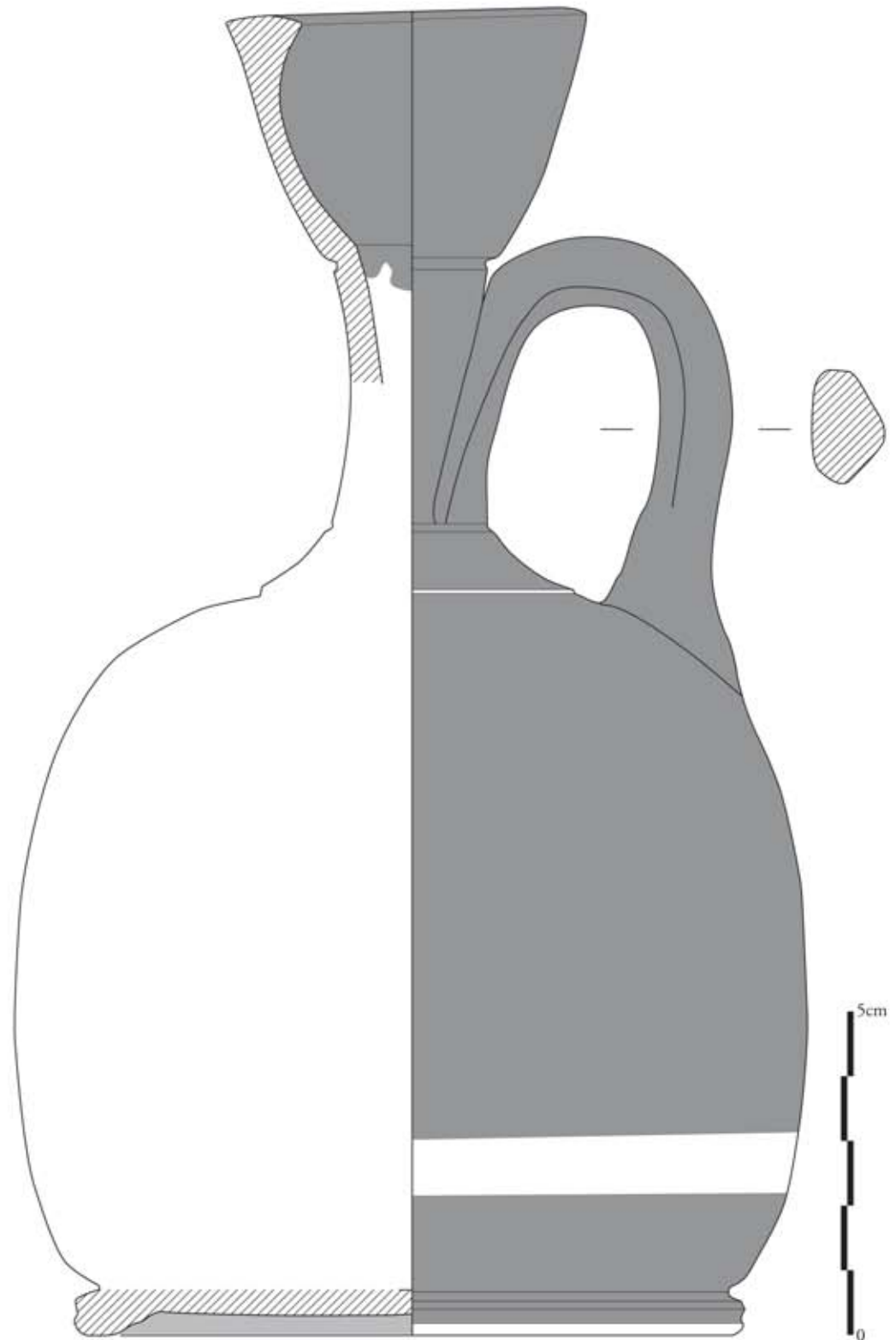

3 (IV 3765)

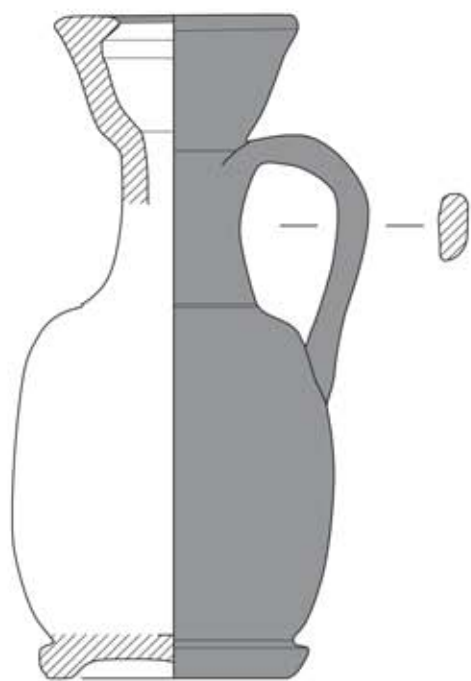

1 (IV 1018)

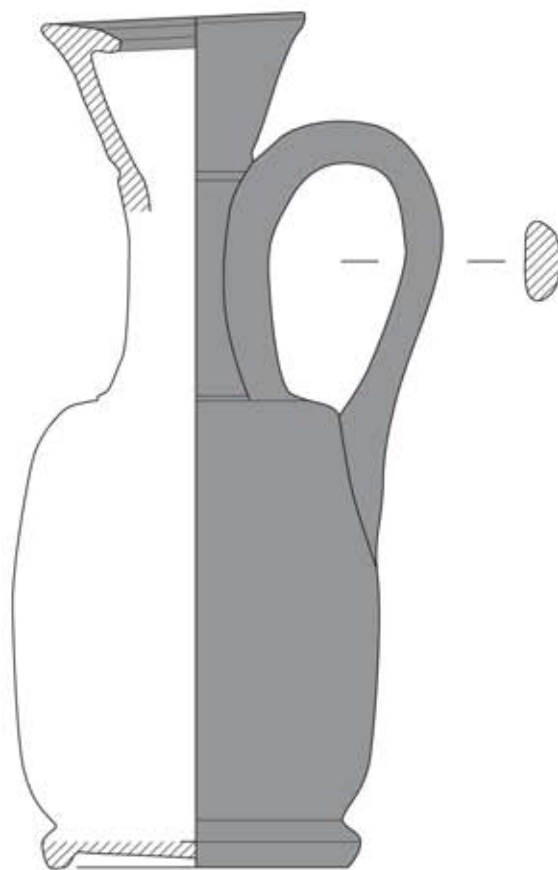

2 (IV 1054)

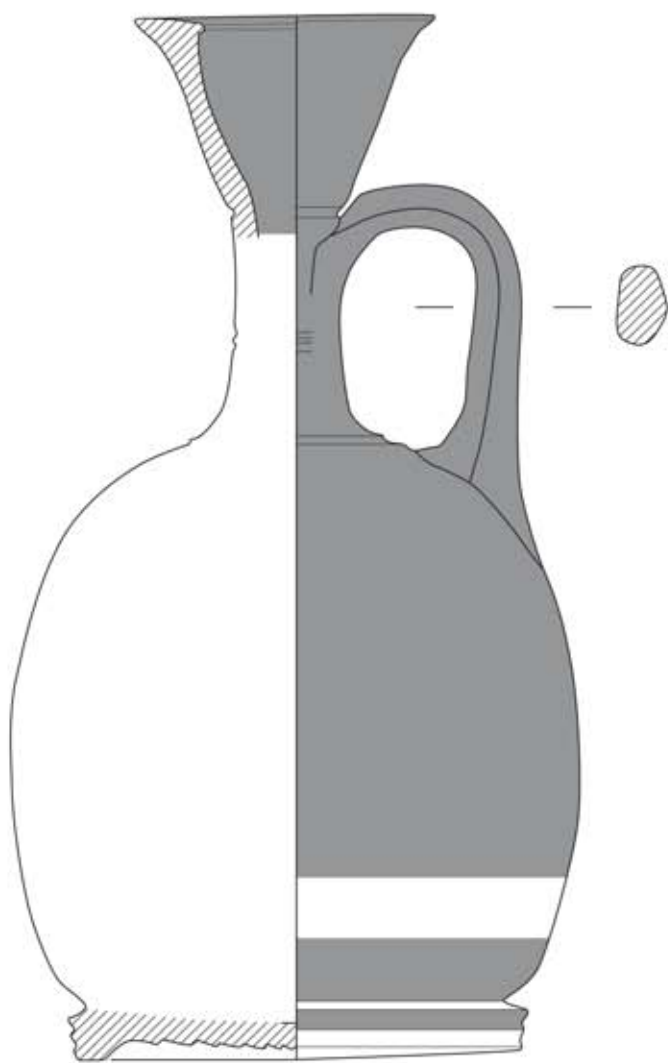

3 (IV 1442)

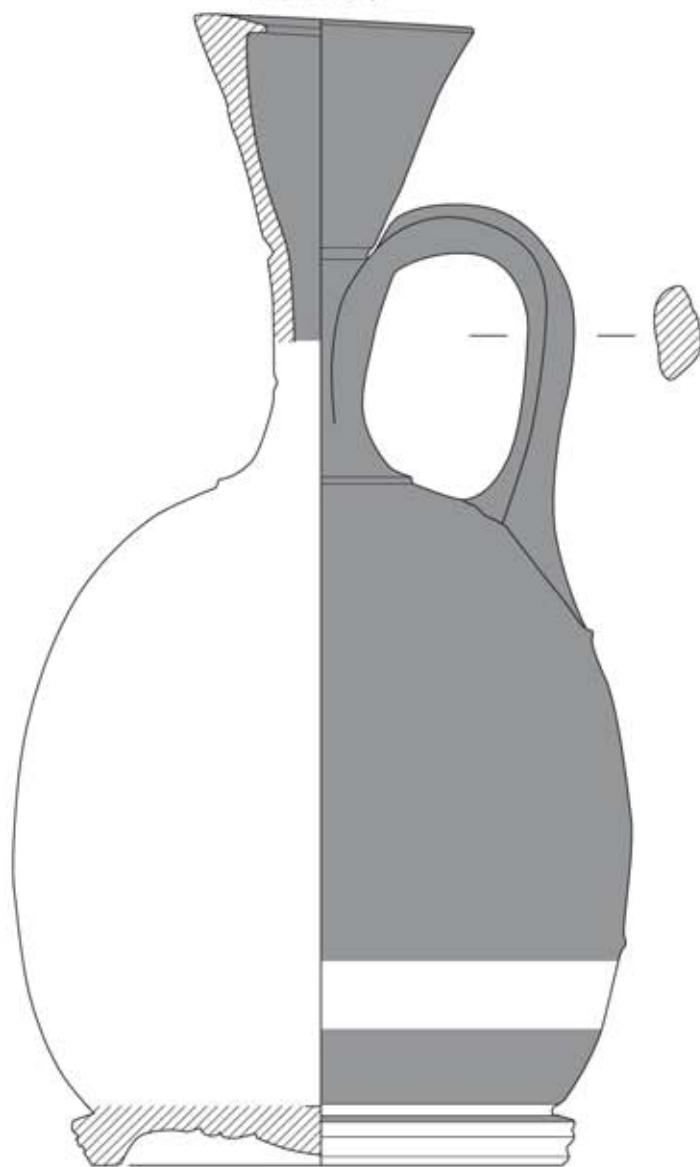

4 (IV 1441)



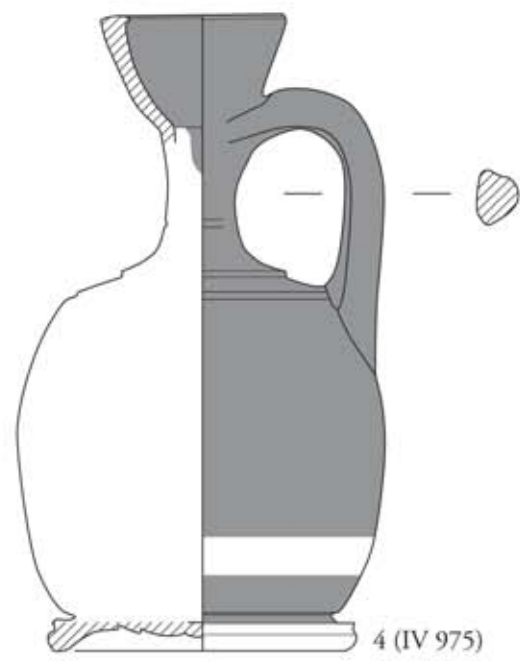
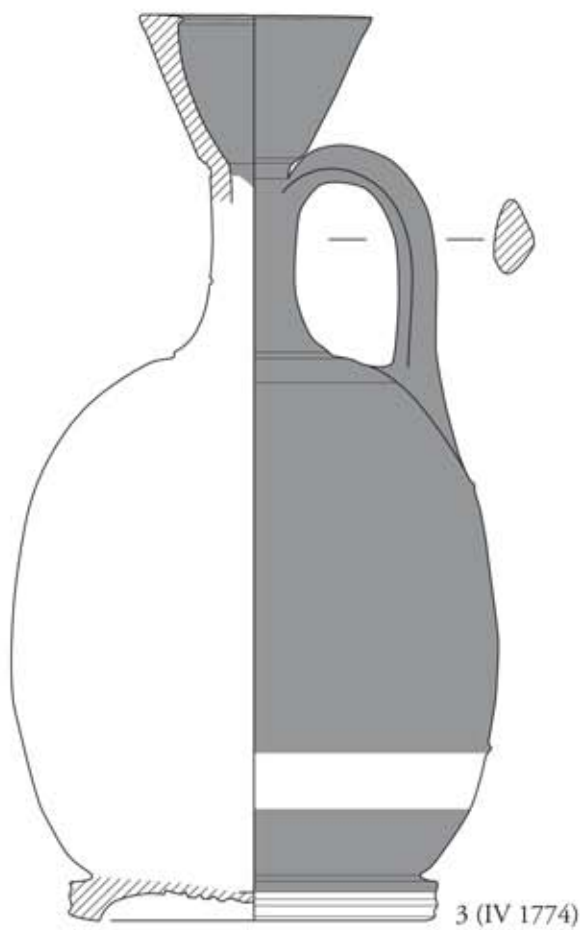
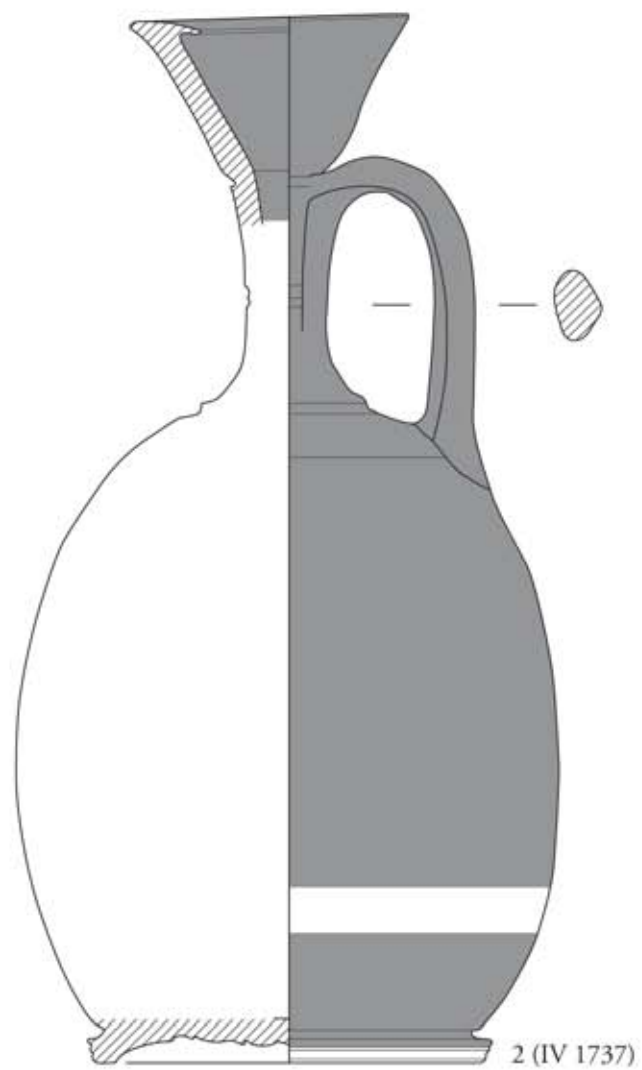
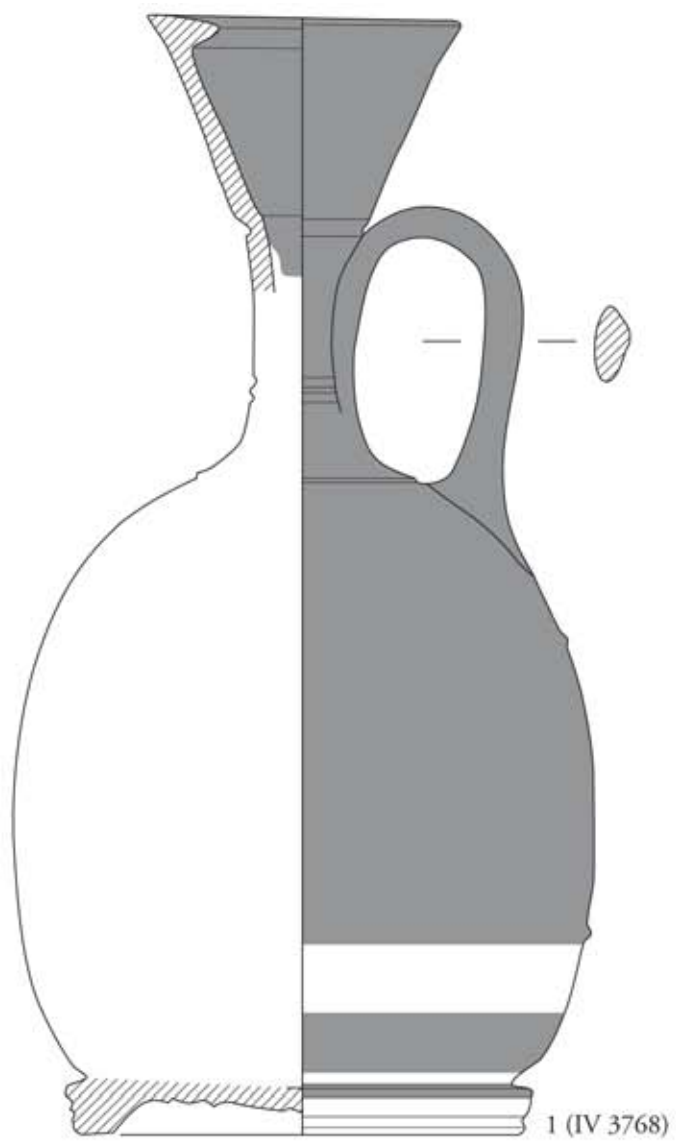

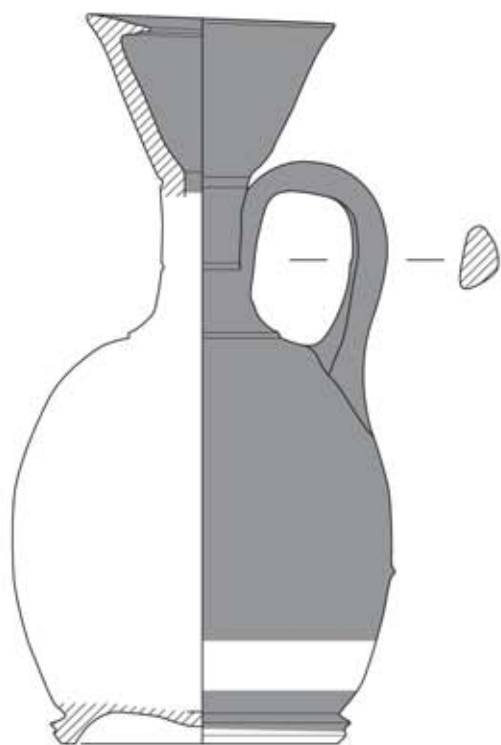

1 (IV 1784)

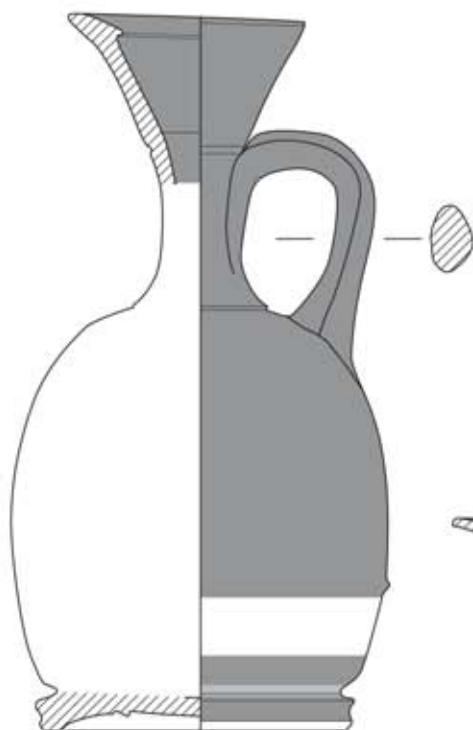

2 (IV 3767)

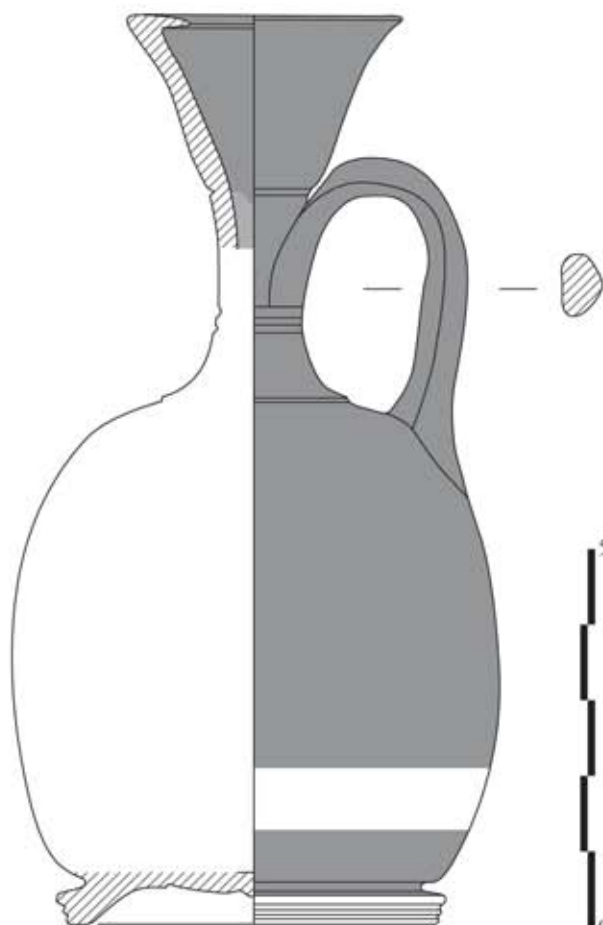

3 (IV 1443)

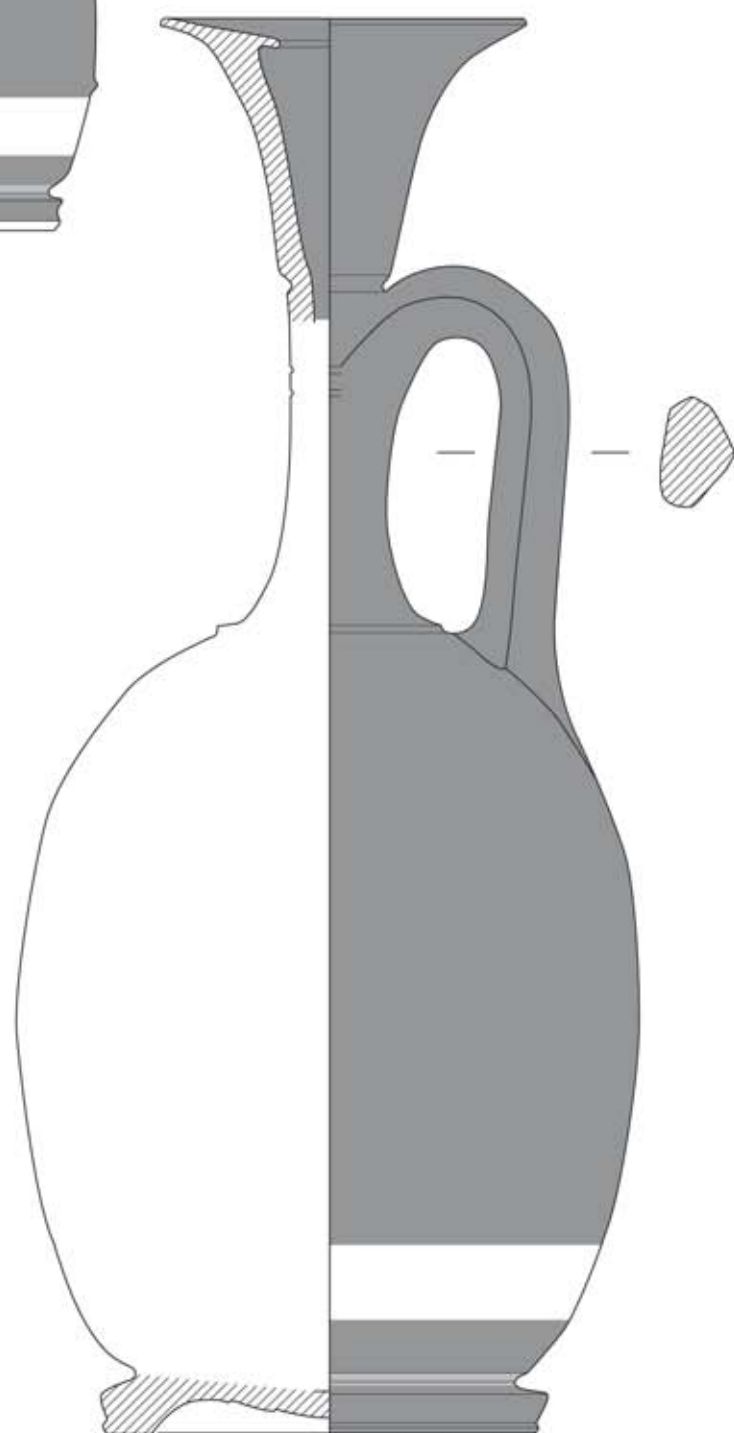

4 (IV 3766)

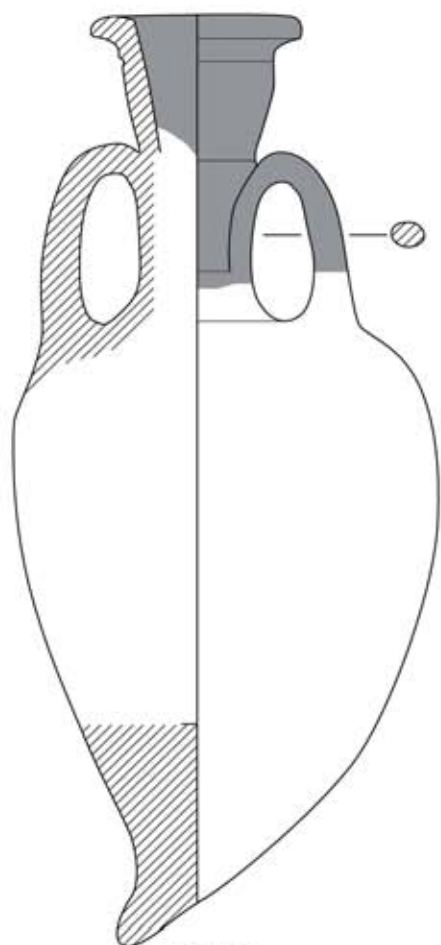

1 (IV 768)

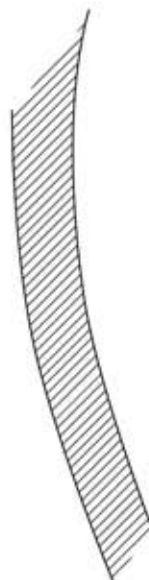

2 (IV 3440)

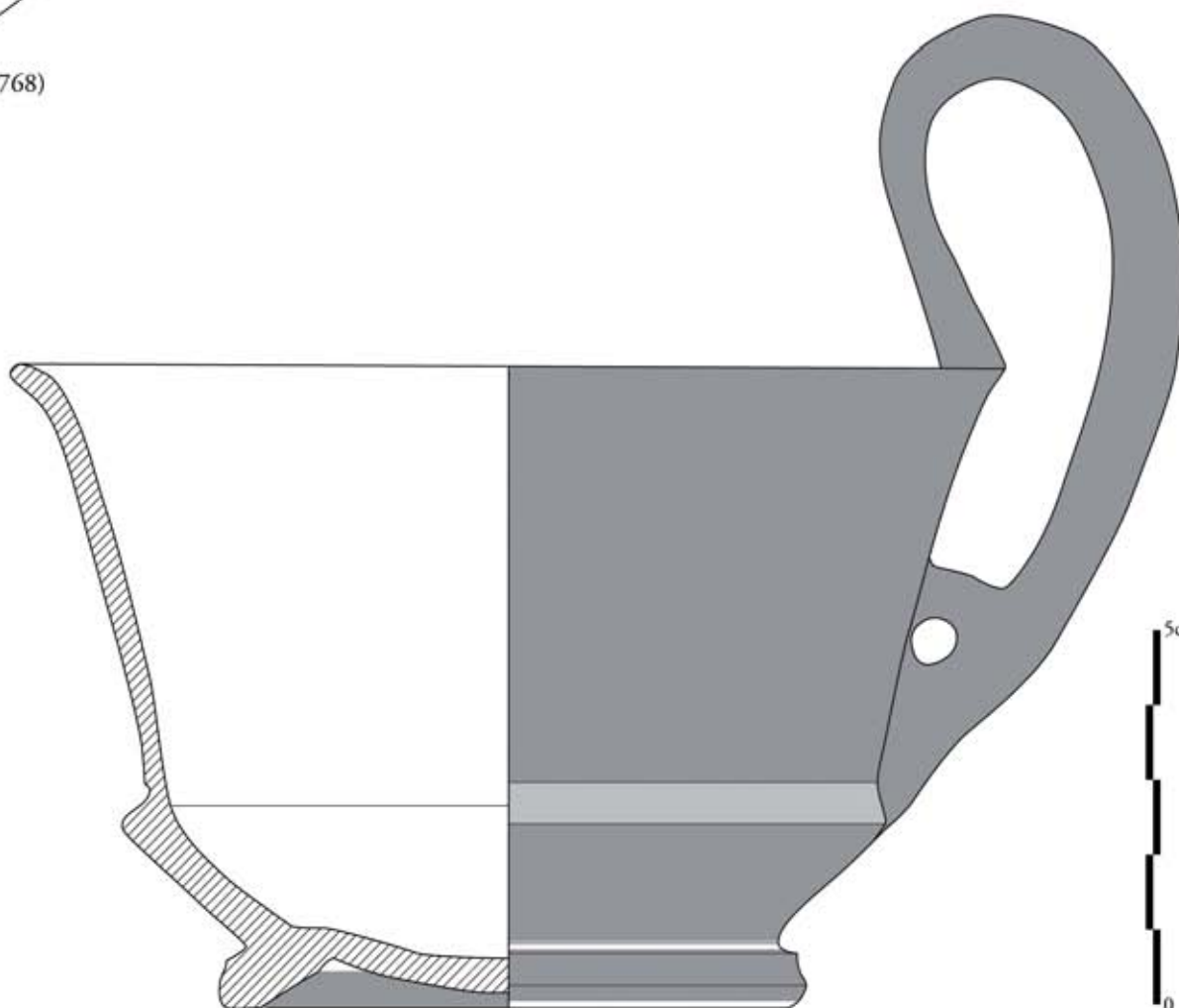

3 (IV 4438)



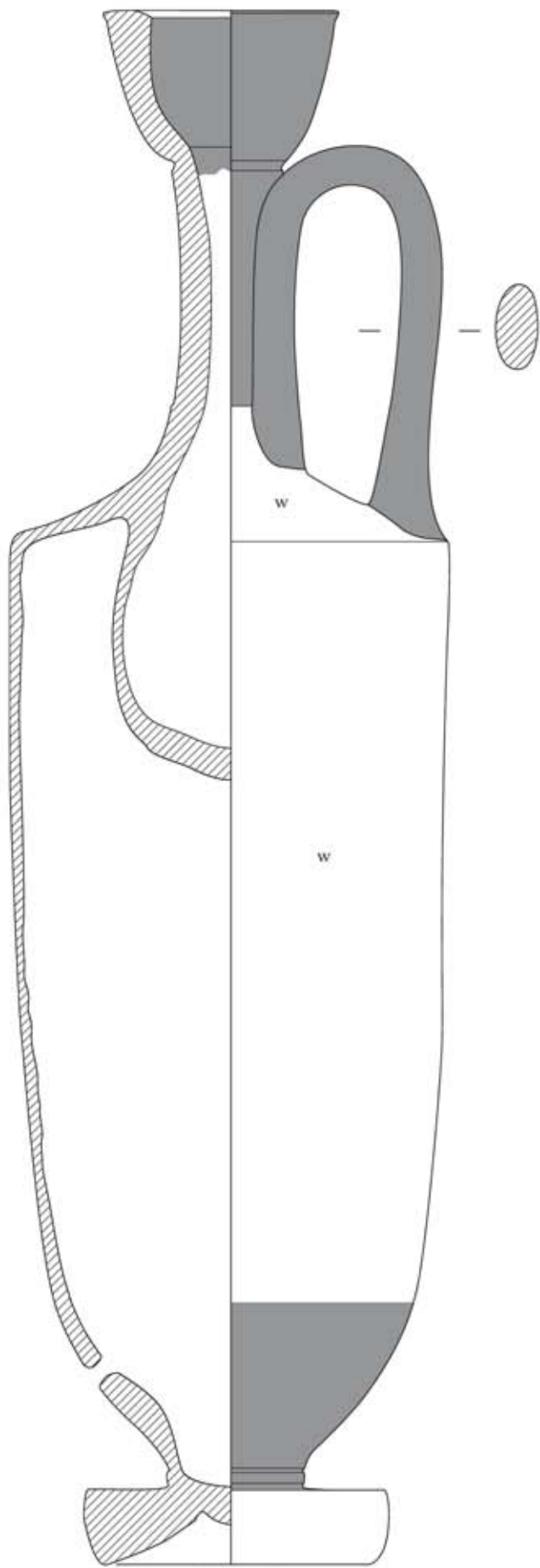

1 (IV 1873)

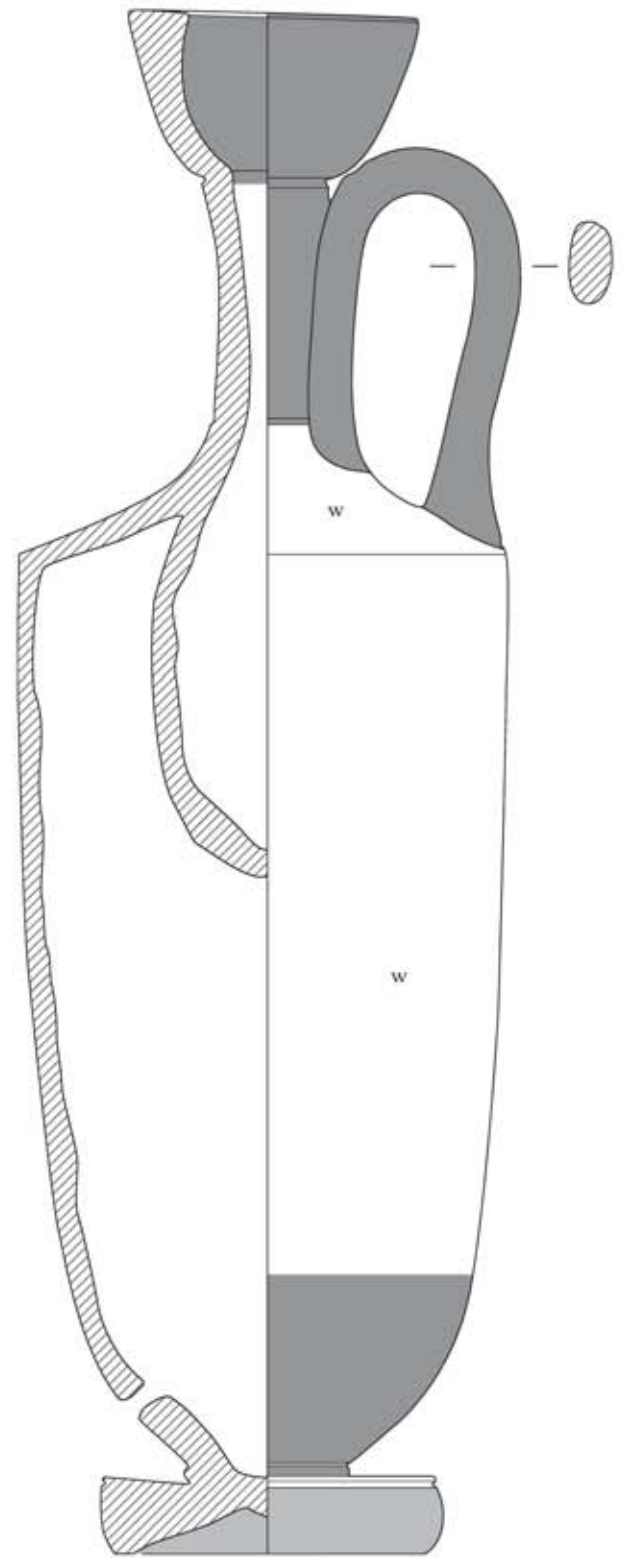

2 (IV 3746)



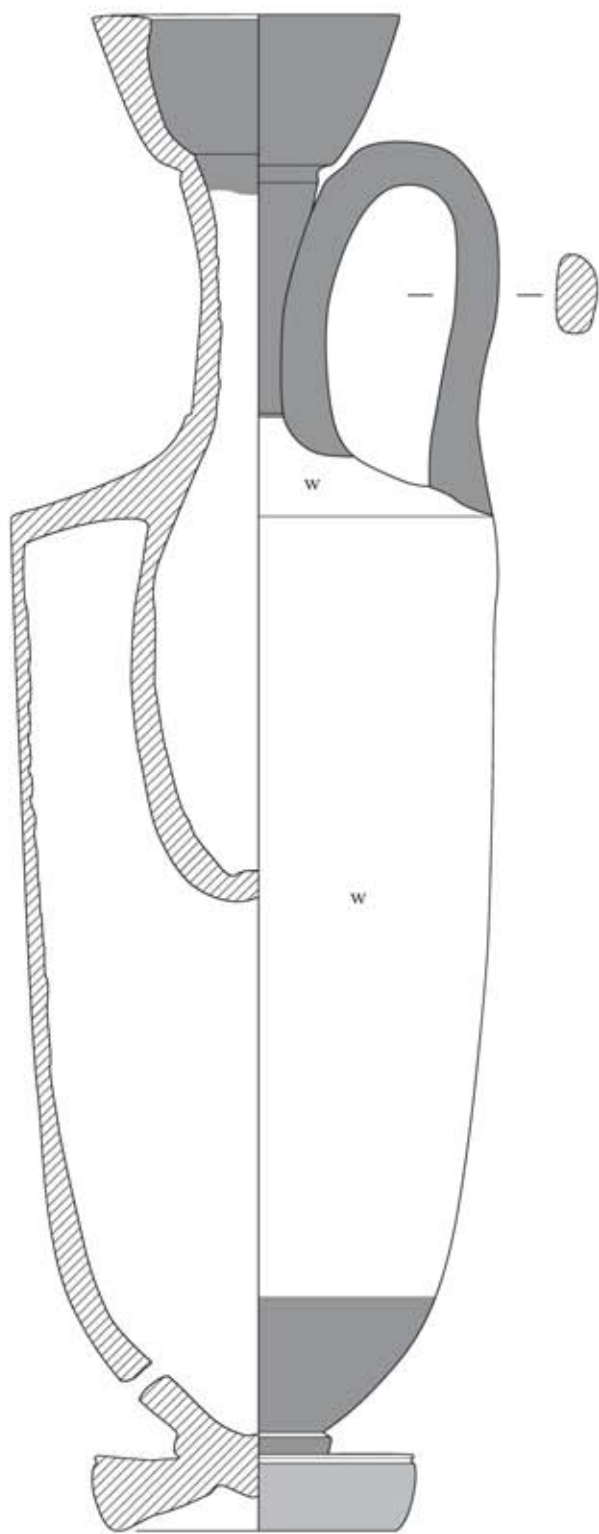

1 (IV 3745)

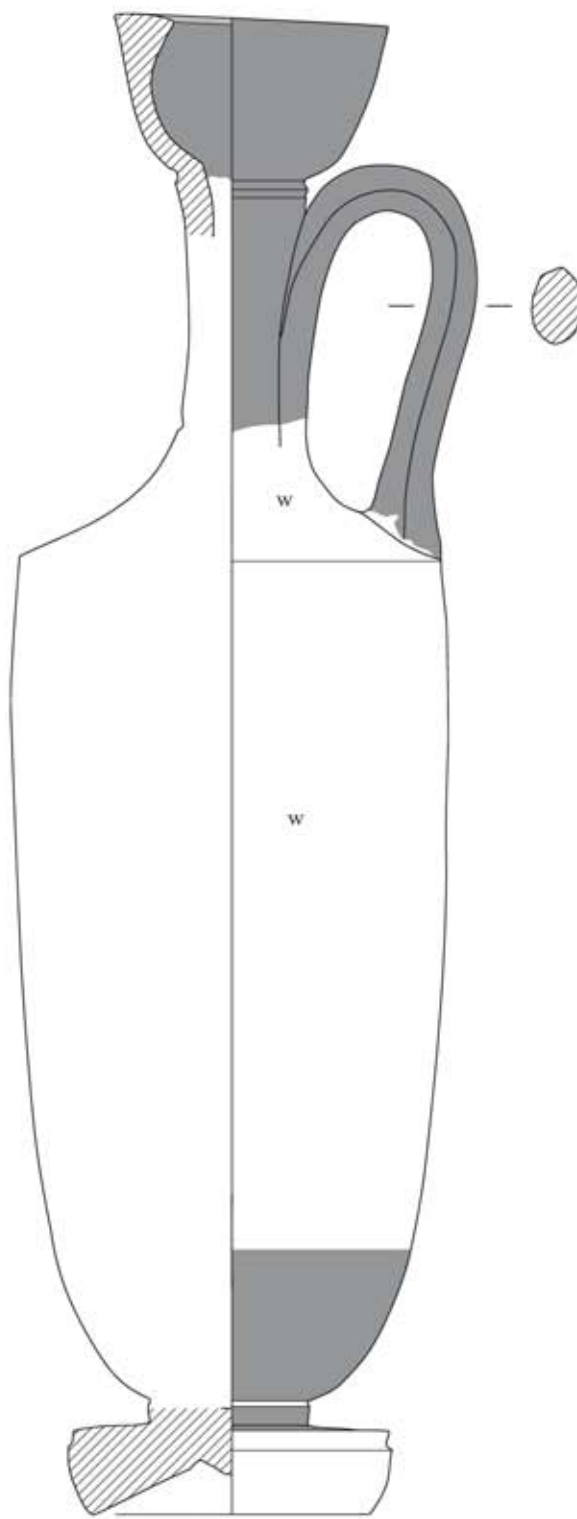

2 (IV 3744)



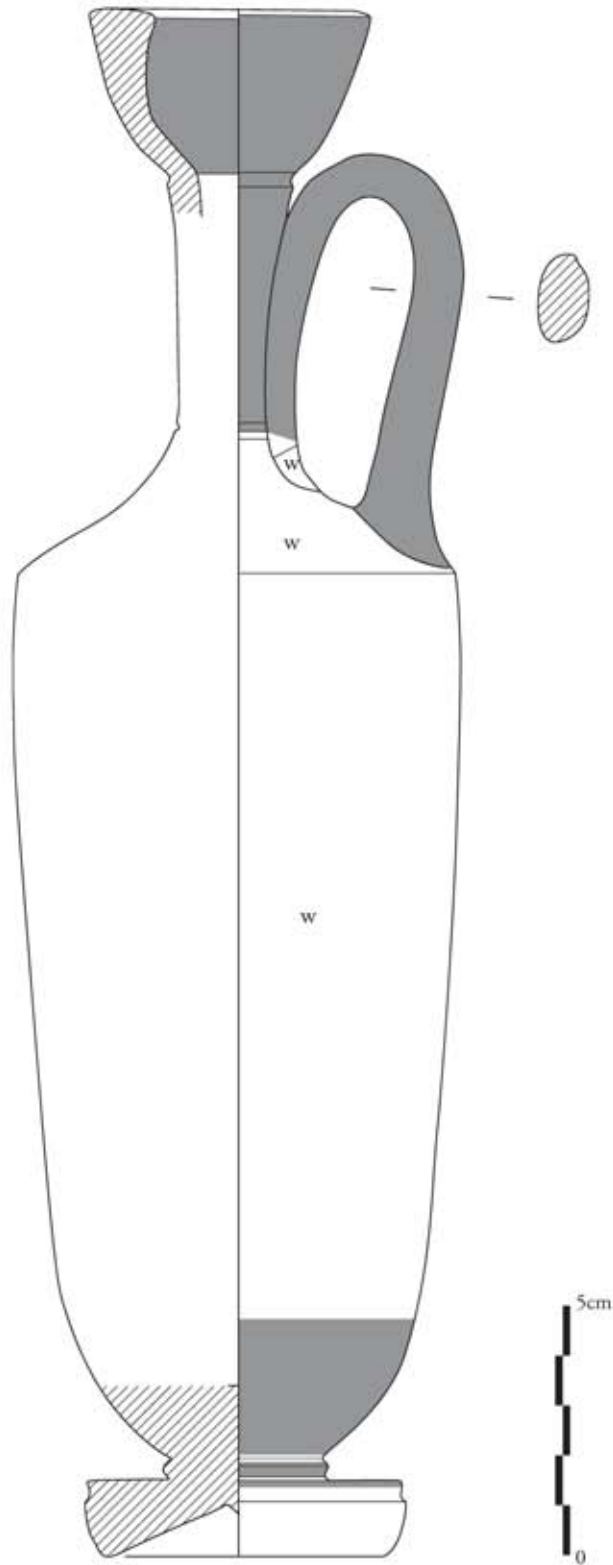

1 (IV 3743)

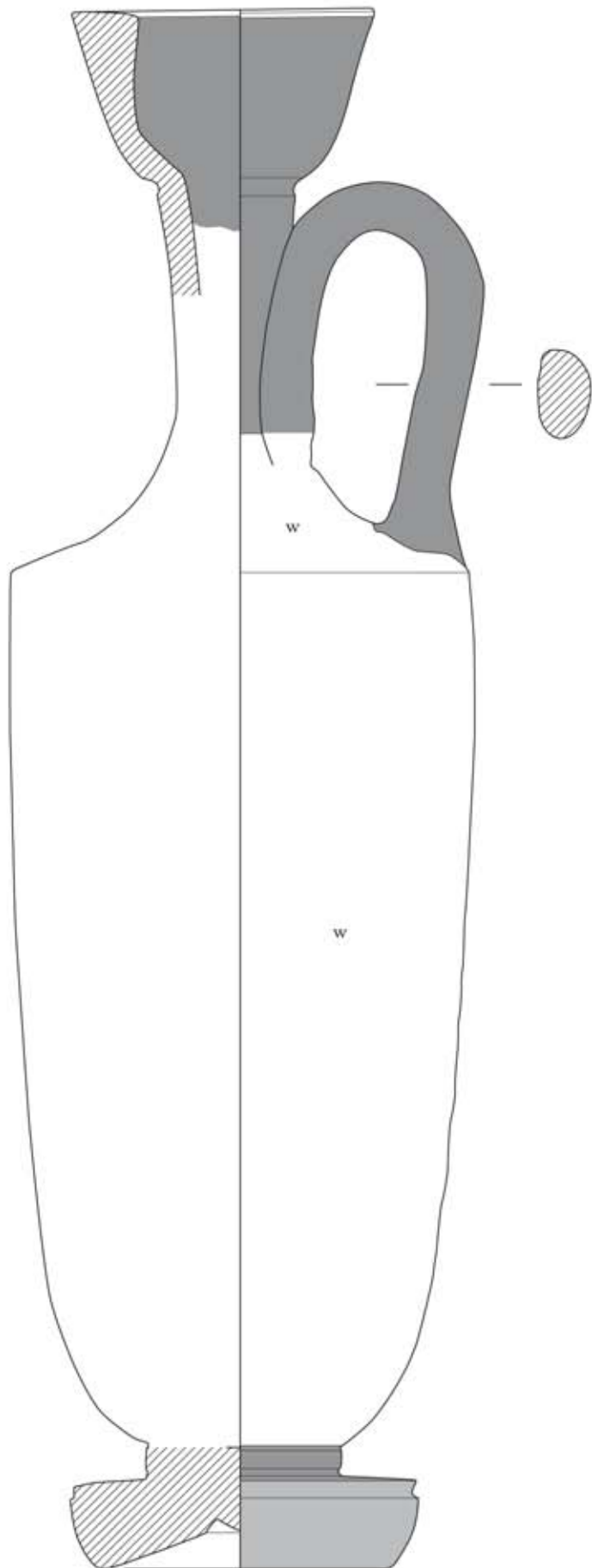

1 (IV 145)

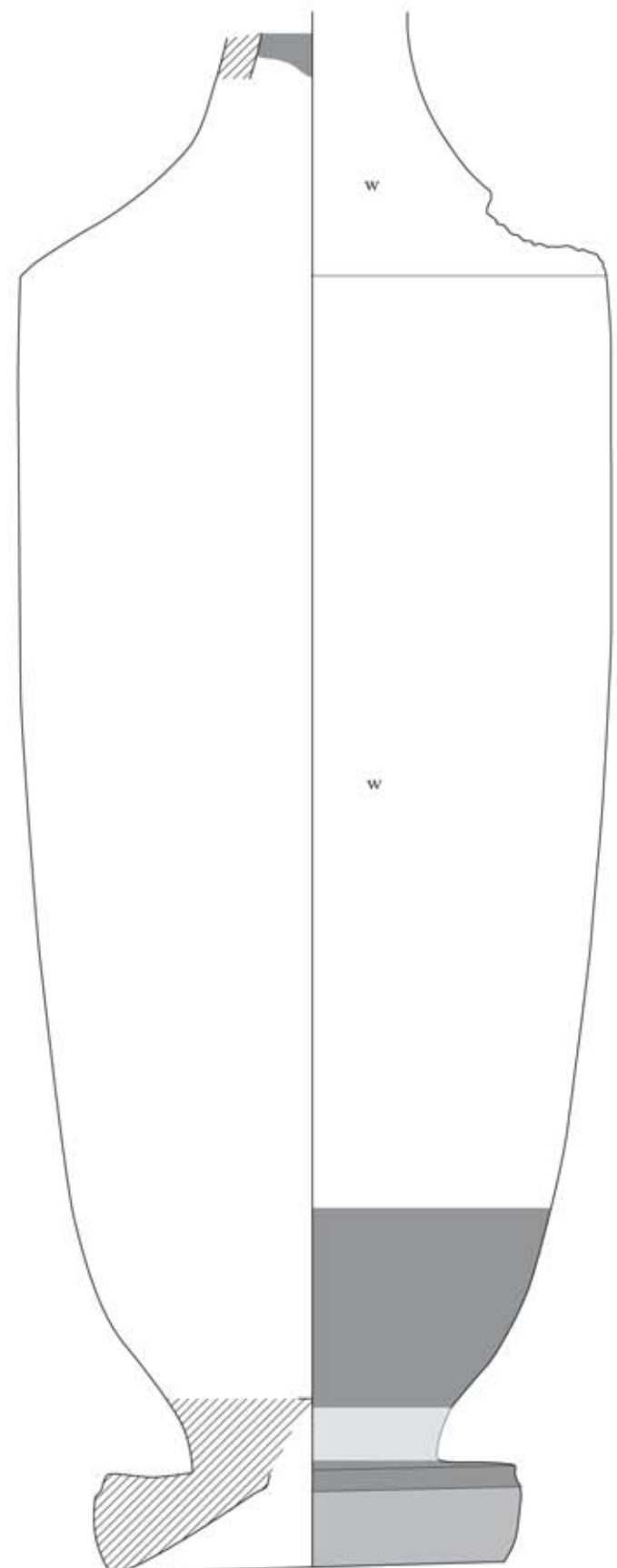

2 (IV 3749)

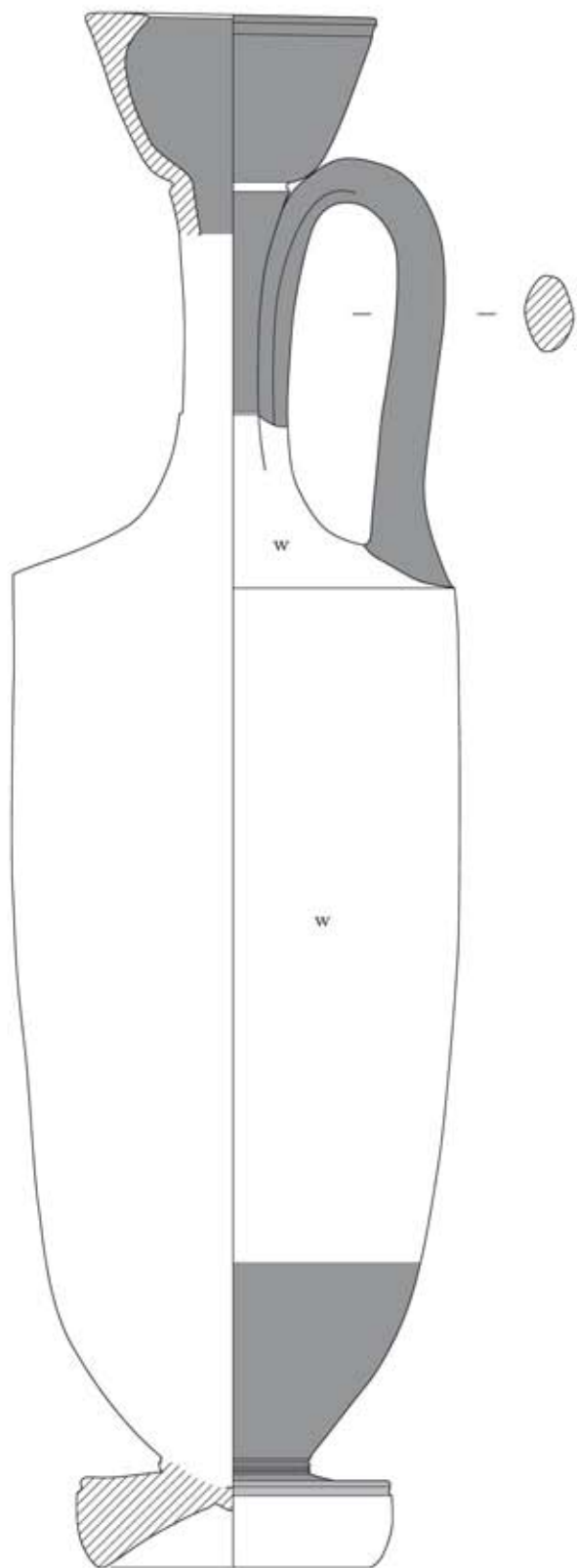

1 (IV 1970)

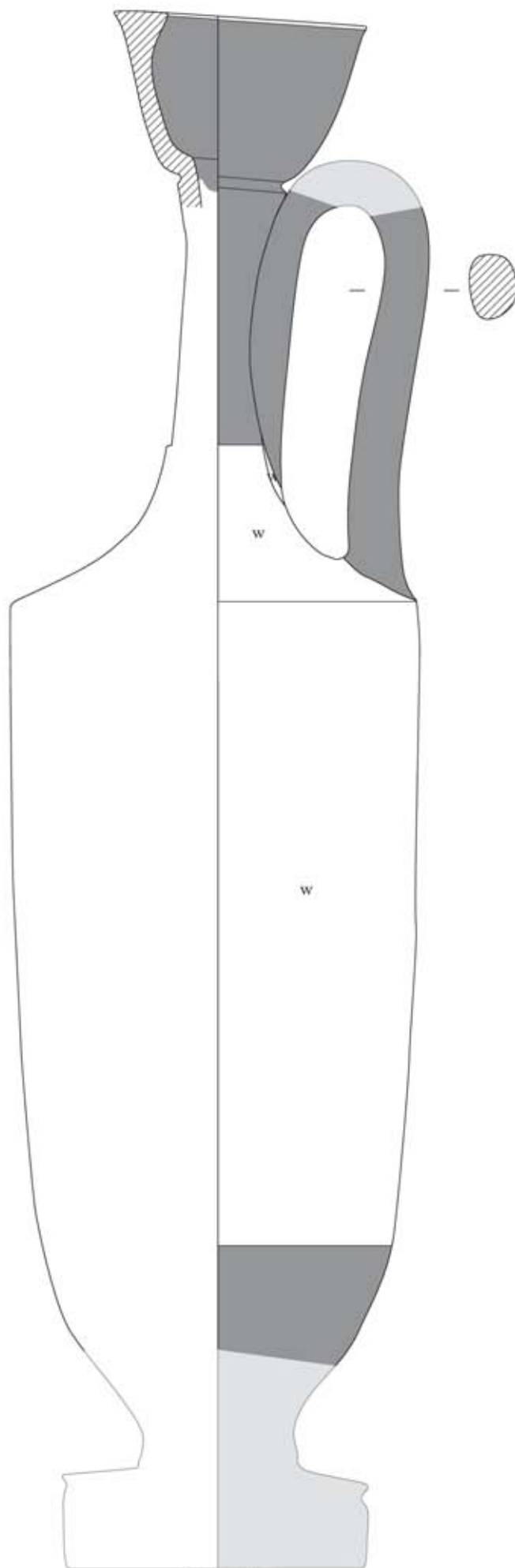

2 (IV 3748)

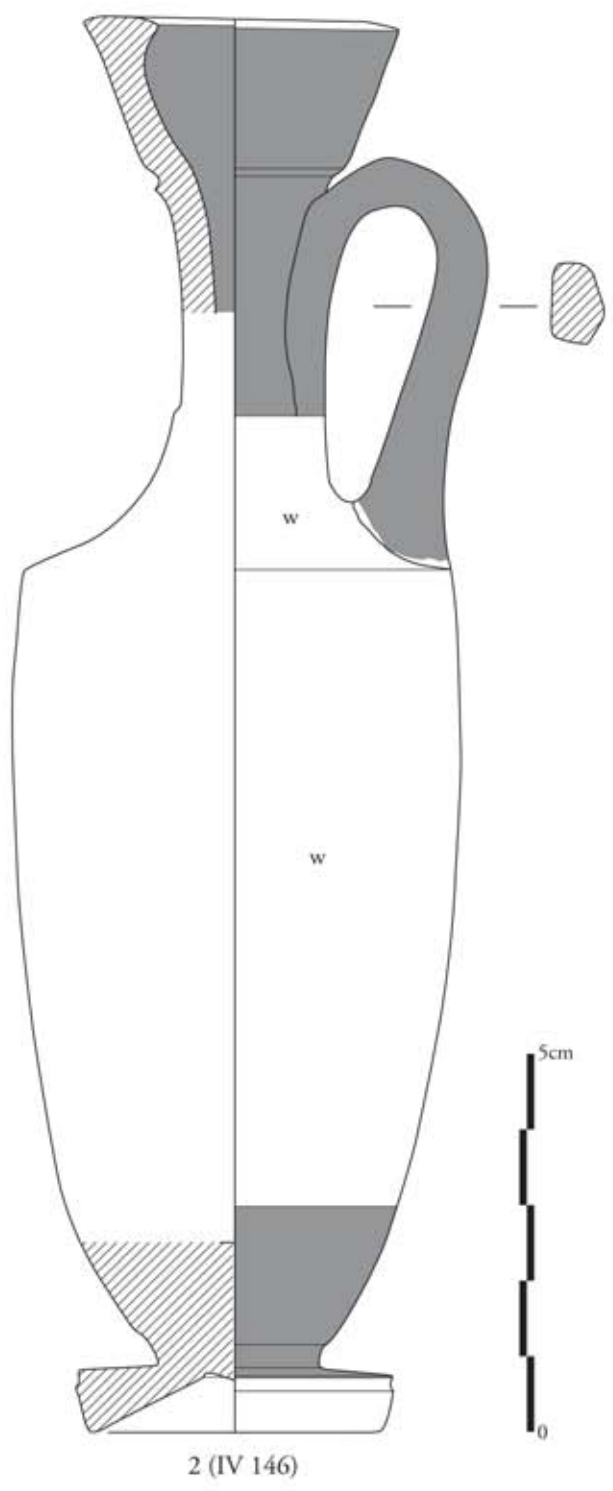
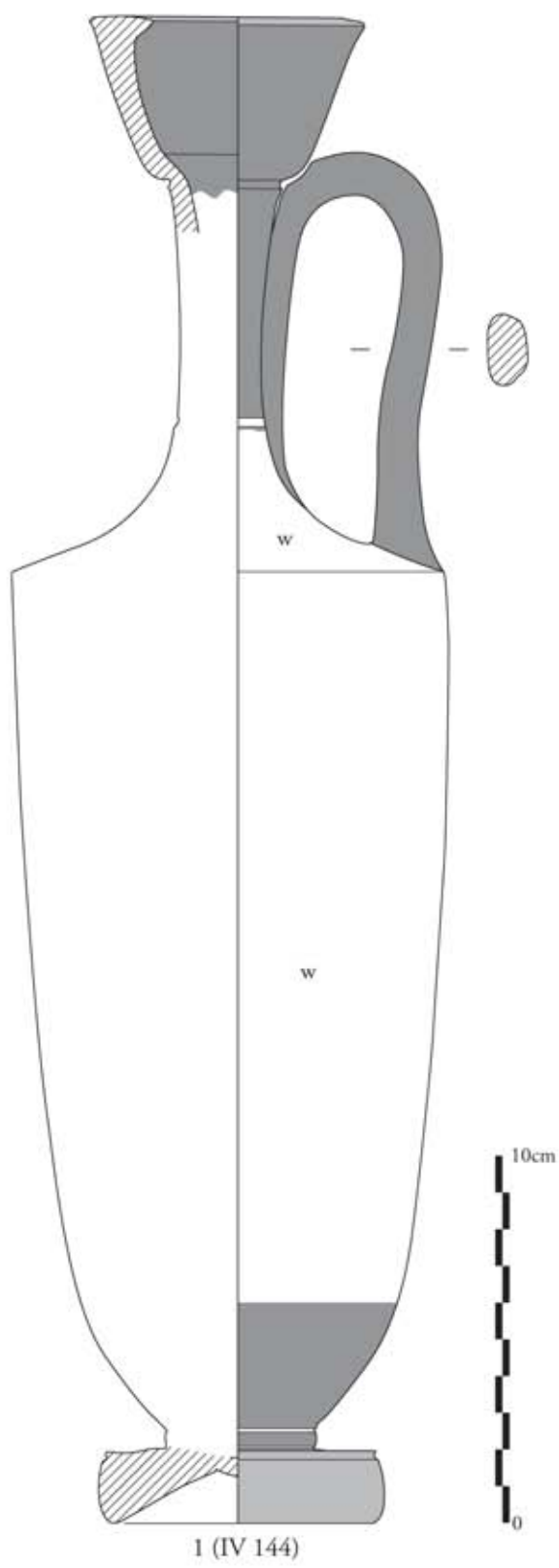

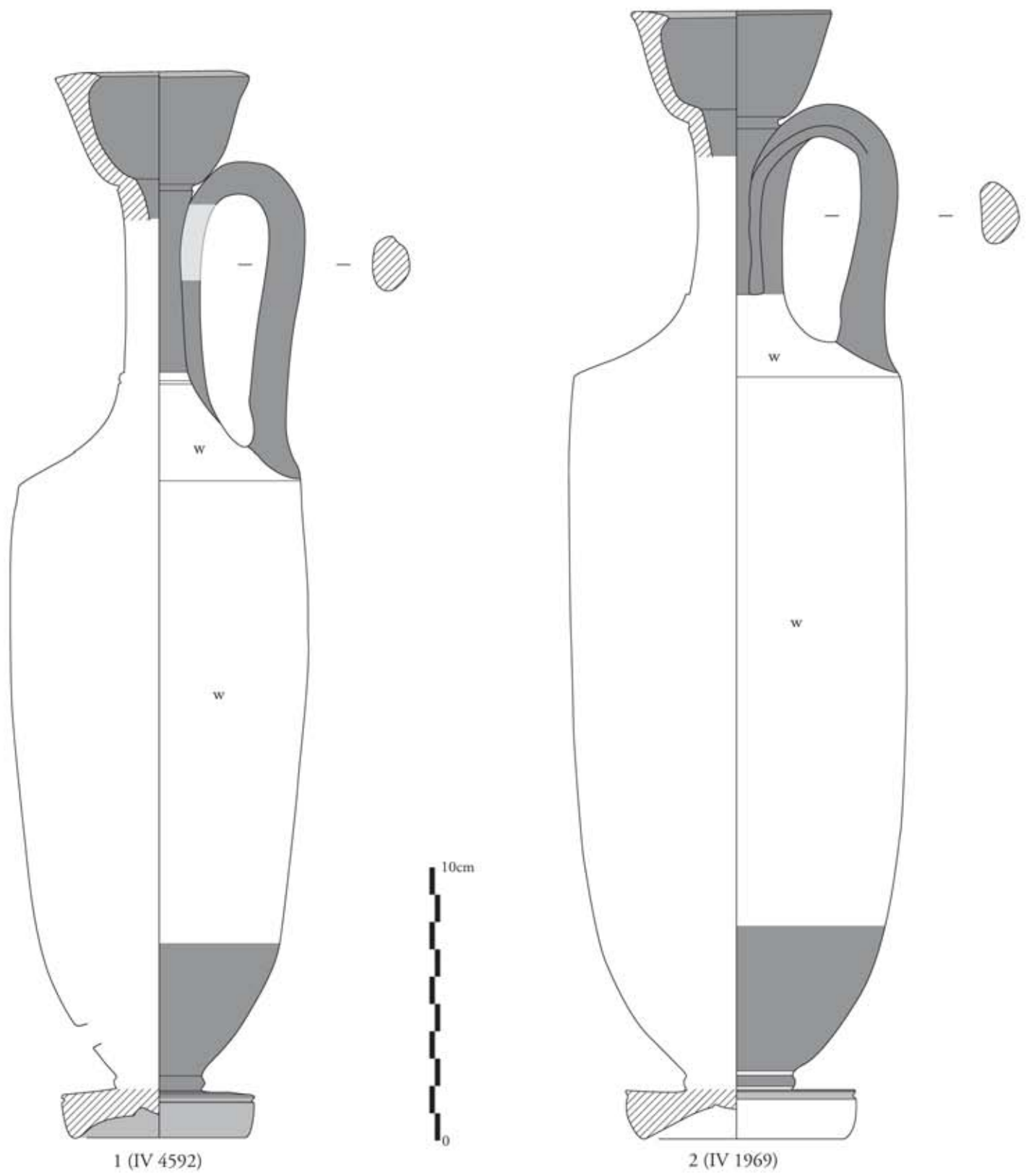

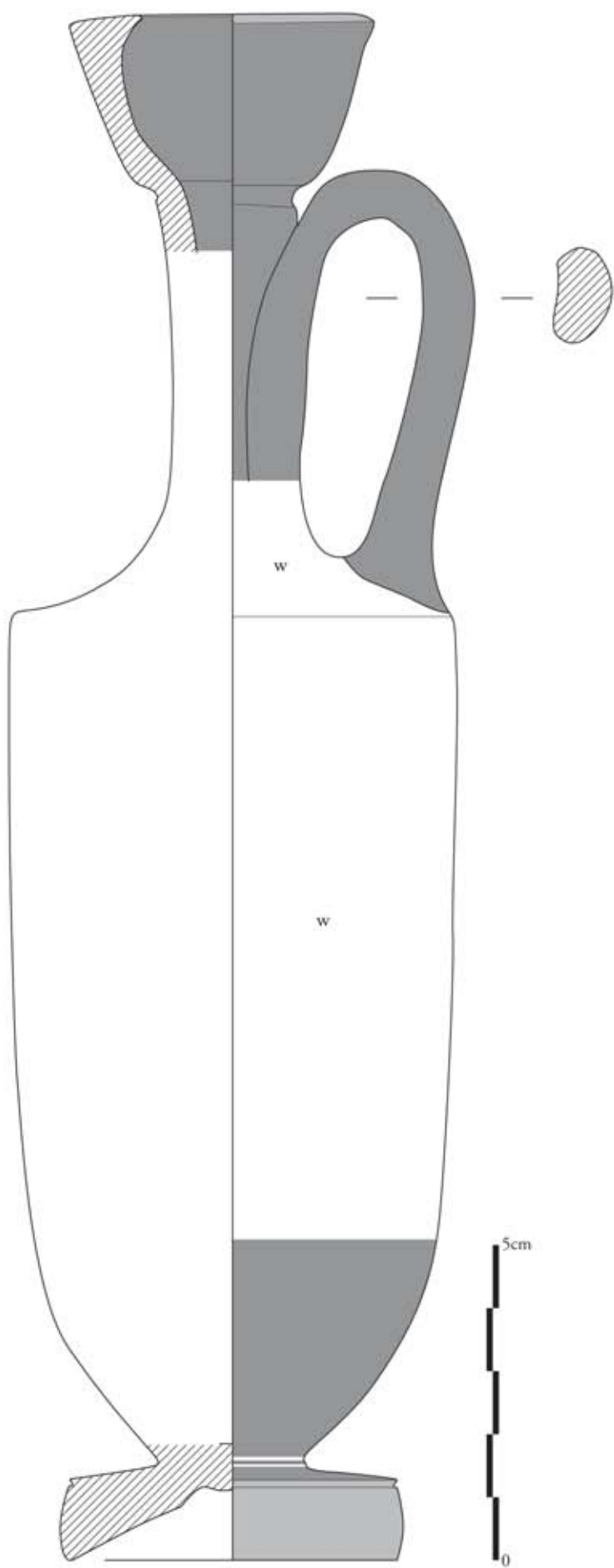

1 (IV 3747)

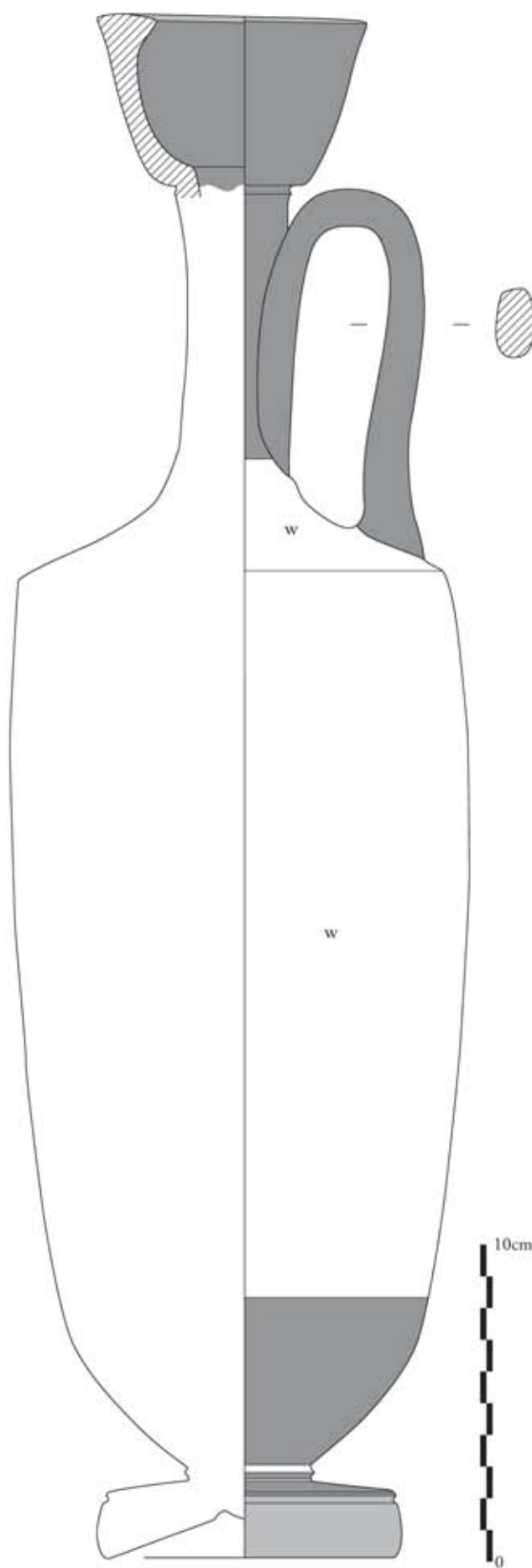

2 (IV 143)

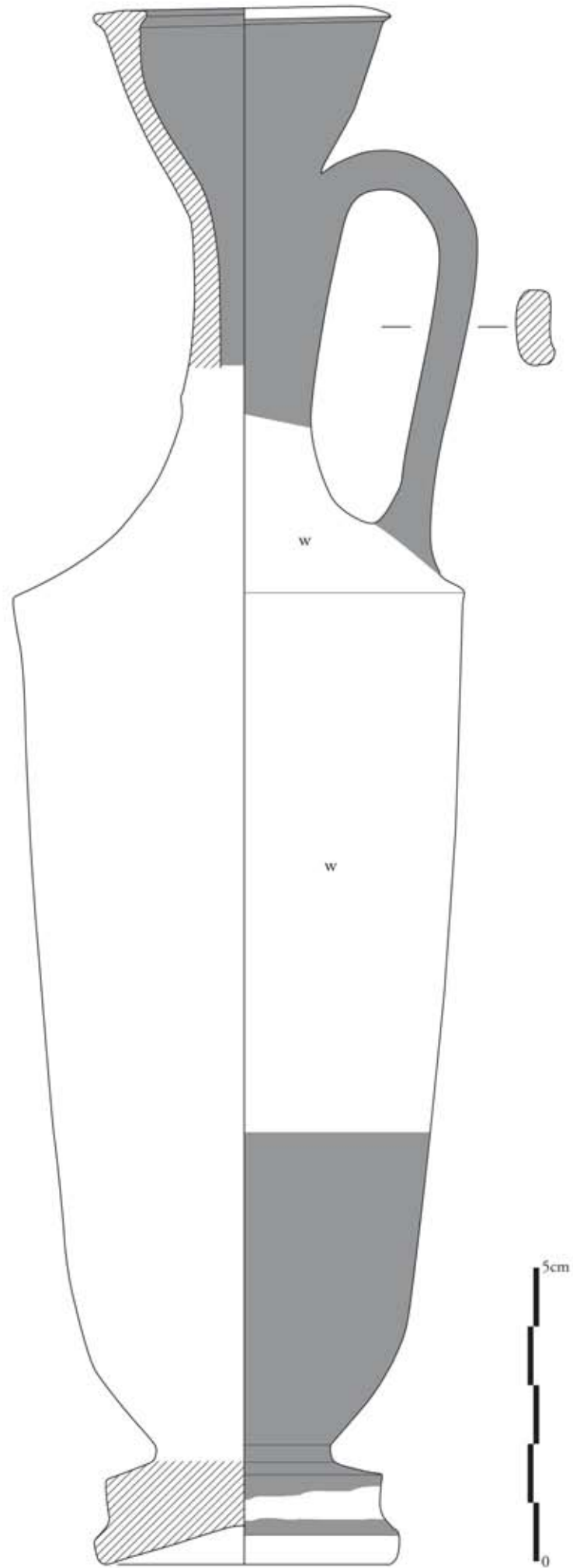

1 (IV 3218)



TAFEL XIV



Antikensammlung Berlin, Inv. Nr. 144

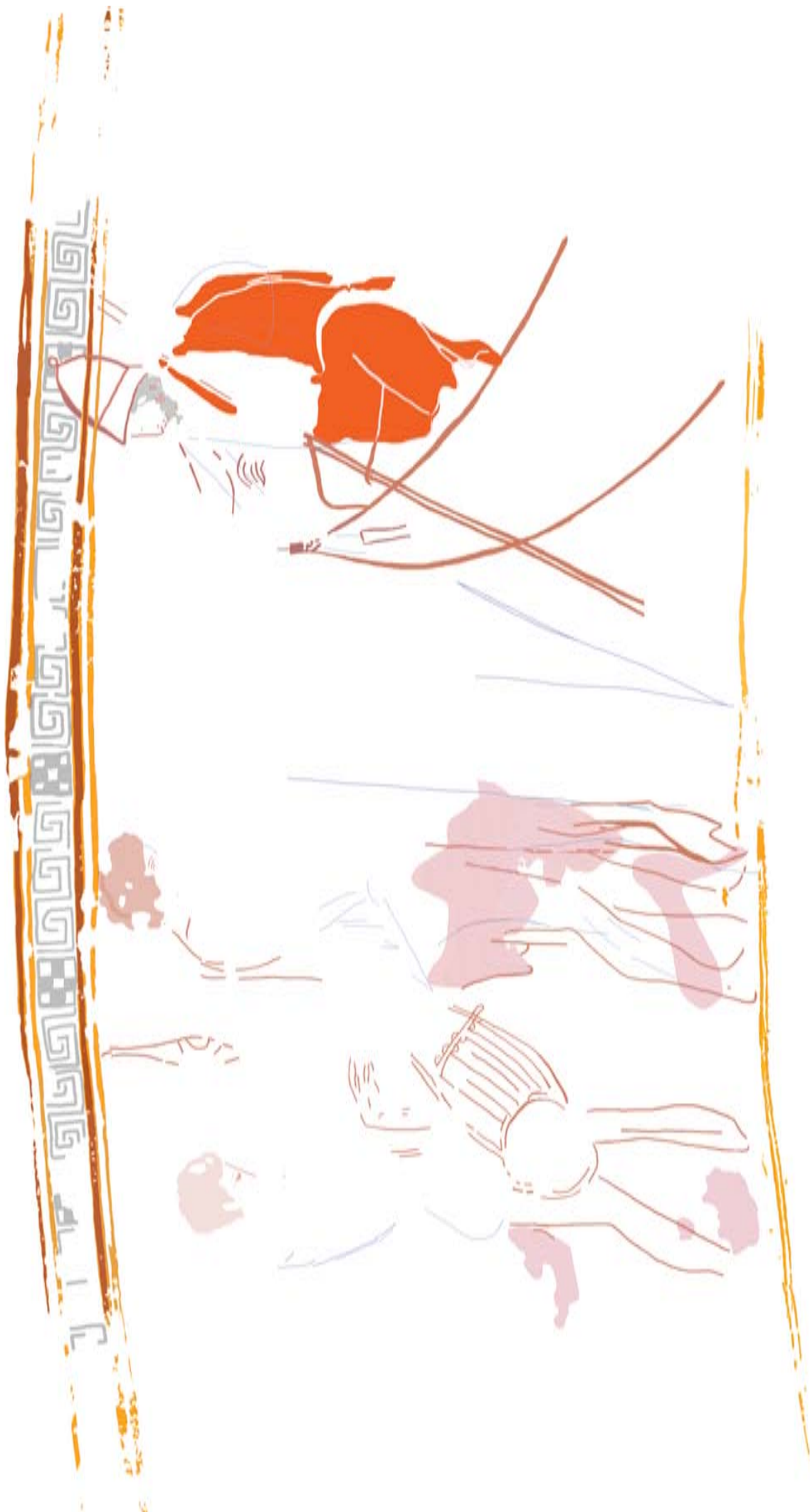

(IV 3473)