

# **ÜBERBLICK ÜBER DIE FUNDE IN DEN LOCI**

(Funde, die nicht gezeichnet wurden (= „n.g.“), sind nicht abgebildet.  
Silices sind in den Abb. S1 – S33 abgebildet)



## REGISTER TAFELN – LOCI

Taf. 1	L2	Taf. 52	L137, L142, L143
Taf. 2	L5, L8, L9, L12	Taf. 53	L155, L156
Taf. 3	L16, L17	Taf. 54	L161, L163/164, L164
Taf. 4	L18, L19	Taf. 55	L165, L170, L171, L172
Taf. 5	L20, L22, L24	Taf. 56	L173
Taf. 6	L25	Taf. 57	L176 (1)
Taf. 7	L26	Taf. 58	L176 (2)
Taf. 8	L27	Taf. 59	L176 (3)
Taf. 9	L28	Taf. 60	L182, L184, L185, L187, L198, L200
Taf. 10	L30	Taf. 61	L201, L206, L208
Taf. 11	L31 (1)	Taf. 62	L209, L211, L212/213, L216
Taf. 12	L31 (2)	Taf. 63	L217
Taf. 13	L31 (3)	Taf. 64	L221, L226, L228
Taf. 14	L31 (4)	Taf. 65	L231, L232
Taf. 15	L32 (1)	Taf. 66	L234 (1)
Taf. 16	L32 (2), L34	Taf. 67	L234 (2)
Taf. 17	L35	Taf. 68	L234 (3), L235
Taf. 18	L36	Taf. 69	L238, L239, L241, L242, L243, L244
Taf. 19	L37	Taf. 70	L245, L246
Taf. 20	L38	Taf. 71	L247
Taf. 21	L39 (1)	Taf. 72	L249, L250, L252, L253
Taf. 22	L39 (2)	Taf. 73	L254
Taf. 23	L39 (3)	Taf. 74	L255, L256, L259
Taf. 24	L40, L41, L45	Taf. 75	L261, L266, L269, L270, L271, L272
Taf. 25	L47	Taf. 76	L273, L281, L282, L284, L285
Taf. 26	L48, L50	Taf. 77	L291, L292, L294, L296
Taf. 27	L51, L53, L54	Taf. 78	L298, L299, L301
Taf. 28	L55, L56, L57, L62	Taf. 79	L302
Taf. 29	L76	Taf. 80	L303, L306, L307, L308, L310, L312, L313
Taf. 30	L77 (1)	Taf. 81	L314, L315, L320, L321, L323
Taf. 31	L77 (2)	Taf. 82	L333, L337, L338
Taf. 32	L77 (3)	Taf. 83	L339, L340, L341, L342, L343, L346, L347
Taf. 33	L78 (1)	Taf. 84	L349, L350, L352
Taf. 34	L78 (2)	Taf. 85	L355, L356, L357, L359
Taf. 35	L78 (3)	Taf. 86	L360, L361
Taf. 36	L78 (4)	Taf. 87	L362, L363
Taf. 37	L78 (5)	Taf. 88	L364, L366, L367
Taf. 38	L79	Taf. 89	L368, L371, L373, L376, L379
Taf. 39	L85	Taf. 90	L380, L383, L386
Taf. 40	L90	Taf. 91	L387, L396, L398, L400, L405, L408, L411, L413, L416
Taf. 41	L93, L94, L95	Taf. 92	L417, L418
Taf. 42	L99	Taf. 93	L419, L420
Taf. 43	L102	Taf. 94	L421
Taf. 44	L103 (1)	Taf. 95	L422, L423, L424
Taf. 45	L103 (2), L104	Taf. 96	L431, L444, L446, L449, L452
Taf. 46	L105 (1)	Taf. 97	L454, L455, L457
Taf. 47	L105 (2)	Taf. 98	L468, L469, L479
Taf. 48	L106	Taf. 99	L481, L482 (1)
Taf. 49	L107	Taf. 100	L482 (2), L483
Taf. 50	L110, L111, L112, L113, L115	Taf. 101	L484, L485/486/488/489/490, L488, L489
Taf. 51	L130, L132, L136	Taf. 102	L487

Taf. 103	L491, L492, L494, L498, L499
Taf. 104	L502, L504
Taf. 105	L507, L511, L512
Taf. 106	L513, L514, L516
Taf. 107	L517, L519
Taf. 108	L520 (1)
Taf. 109	L520 (2)
Taf. 110	L520 (3)
Taf. 111	L520 (4)
Taf. 112	L520 (5), L521, L522
Taf. 113	L523
Taf. 114	L526
Taf. 115	L527, L528
Taf. 116	L529, L530, L531 (1)
Taf. 117	L 531 (2)
Taf. 118	L532, L533
Taf. 119	L534, L535
Taf. 120	L536 (1)
Taf. 121	L536 (2), L539, L540, L542
Taf. 122	L544, L545, L547, L548
Taf. 123	L550, L551, L555, L557, L558, L560, L561, L564
Taf. 124	L567, L568, L569, L576
Taf. 125	L579
Taf. 126	L580, L583, L584
Taf. 127	L585 (1)
Taf. 128	L585 (2)
Taf. 129	L587
Taf. 130	L590 (1)
Taf. 131	L590 (2)
Taf. 132	L590 (3), L586
Taf. 133	L591
Taf. 134	L596, L597
Taf. 135	L598, L493/599
Taf. 136	L601 (1)
Taf. 137	L601 (2), L602
Taf. 138	L603
Taf. 139	L604, L614, L615, L621, L622
Taf. 140	L620, L624, L627, L629, L634, L639
Taf. 141	L647 (1)
Taf. 142	L647 (2)
Taf. 143	L649, L650, L653, L654
Taf. 144	j/61, Gru. 2 (nach Ä&L 11, 19, Abb. 3)
Taf. 145	j/61, Gru. 2 (nach Ä&L 11, 19, Abb. 4)
Taf. 146	j/61, Gru. 2
Taf. 147	k/58, M130; k/58, zw. M669 und M670; k/58, Gru. 1; k/58, Gru. 19; k/59, M674; k/59, M690; k/59, Gru. 22; k/59-O, Gru. 7; k/59-O, Gru. 15
Taf. 148	k/59, Gru. 12; k/59, Gru. 18
Taf. 149	k/59-O, Gru. 22; k/59-60, Gru. 10
Taf. 150	k/60, Gru. 6
Taf. 151	k/60, Gru. 14; k/61, Profilgräben; k/61, M618, Fgr. ; k/61, M144a; k/61, Gru. 1
Taf. 152	k/61, Gru. 3 (=l/61, Gru. 1=l/62, gr. Störung)
Taf. 153	k/61, Gru. 4
Taf. 154	k/61, Gru. 11; l/59, M678/679/680; l/61, M153/156; l/61, M166; l/61, M182; l/61, U1; l/61, Gru. 9; l/61, Gru. 10; l/61, Gru. 13; l/61, Gru. 22
Taf. 155	l/61, Gru. 23; l/61, Gru. 32; l/61, Gru. 35-40, 43
Taf. 156	l/61, Gru. 31 (1)
Taf. 157	l/61, Gru. 31 (2); l/61, Gru. 1 (=k/61, Gru. 3=l/62, gr. Störung)
Taf. 158	l/62, gr. Störung (=k/61, Gru. 3= l/61, Gru. 1)
Taf. 159	m/57, Gru. 2; m/58, M207/211/213; m/58, Gru. 2; m/58, Gru. 3; m/58, Gru. 14
Taf. 160	m/59, Schnitt am O-Profil; m/60, M686/687/688; m/61, M248; m/61, M249; m/61, M265; m/61, M604/606; m/61, Gru. Im S-Profil
Taf. 161	m/61, Gru. 1 (1)
Taf. 162	m/61, Gru. 1 (2)
Taf. 163	m/61, Gru. 2
Taf. 164	m/61, Gru. 3 (1)
Taf. 165	m/61, Gru. 3 (2); m/61, Gru. 4
Taf. 166	m/61, Gru. 5; m/61, Gru. 6; m/61, Gru. 7
Taf. 167	m/62, M241; m/62, M242; m/62, M263; m/62, M302; m/62, M630; m/62, Mauern str. d (?)
Taf. 168	m/62, ganzes Plq. Str. e/4 – f
Taf. 169	m/62, Gru. 1
Taf. 170	m/62, Gru. 2; m/62, Gru. 4
Taf. 171	m/62, Gru. 17; m/62, O-Profil; n/58; Gru. 16; n/58, Gru. 19; n/59, M418/420/421; n/59, Gru. 5; n/59, Gru. 6; n/59, Gru. 9
Taf. 172	n/59, Gru. 18; n/60, M410/413; n/60, M533; n/60, Gru. 5
Taf. 173	n/60, Gru. 10; n/60, Gru. 11; n/60, Gru. 14
Taf. 174	n/61, M457; n/61, M589-594, 599
Taf. 175	n/61, Gru. 1; n/61, Gru. 2; n/61, Gru. 3; n/61, Gru. 5
Taf. 176	n/62, M596; n/62, Mauern str. c und b; o/59, M519/520; o/59, M513/514/521/560; o/59, M545
Taf. 177	o/59, M554-561; o/59, zw. M561 und M547; o/59, M567
Taf. 178	o/59, Mauern str. c; o/59, Mauern str. e/1; o/59, Mauern str. e/2
Taf. 179	o/59, Gru. 1; o/59, Gru. 2
Taf. 180	o/59, Gru. 5; o/59, Gru. 8
Taf. 181	o/59, Gru. 9; o/59, Gru. 10; o/59, Gru. 11; o/59, Gru. 12; o/59, Gru. 18
Taf. 182	o/59, Gru. 22; o/59, Gru. 25



## REGISTER LOCI – TAFELN

L2	Taf. 1
L5 L8 L9 L12	Taf. 2
L16 L17	Taf. 3
L18 L19	Taf. 4
L20 L22 L24	Taf. 5
L25	Taf. 6
L26	Taf. 7
L27	Taf. 8
L28	Taf. 9
L30	Taf. 10
L31	Taf. 11 Taf. 12 Taf. 13 Taf. 14
L32	Taf. 15 Taf. 16
L34	Taf. 16
L35	Taf. 17
L36	Taf. 18
L37	Taf. 19
L38	Taf. 20
L39	Taf. 21 Taf. 22 Taf. 23
L40 L41 L45	Taf. 24
L47	Taf. 25
L48 L50	Taf. 26
L51 L53 L54	Taf. 27
L55 L56 L57 L62	Taf. 28
L76	Taf. 29
L77	Taf. 30 Taf. 31 Taf. 32
L78	Taf. 33 Taf. 34 Taf. 35 Taf. 36 Taf. 37
L79	Taf. 38

L85	Taf. 39
L90	Taf. 40
L93 L94 L95	Taf. 41
L99	Taf. 42
L102	Taf. 43
L103	Taf. 44 Taf. 45
L104	Taf. 45
L105	Taf. 46 Taf. 47
L106	Taf. 48
L107	Taf. 49
L110 L111 L112 L113 L115	Taf. 50
L130 L132 L136	Taf. 51
L137 L142 L143	Taf. 52
L155 L156	Taf. 53
L161 L163/164 L164	Taf. 54
L165 L170 L171 L172	Taf. 55
L173	Taf. 56
L176	Taf. 57 Taf. 58 Taf. 59
L182 L184 L185 L187 L198 L200	Taf. 60
L201 L206 L208	Taf. 61
L209 L211 L212/213 L216	Taf. 62
L217	Taf. 63
L221 L226 L228	Taf. 64

L231 L232	Taf. 65
L234	Taf. 66 Taf. 67 Taf. 68
L235	Taf. 68
L238 L239 L241 L242 L243 L244	Taf. 69
L245 L246	Taf. 70
L247	Taf. 71
L249 L250 L252 L253	Taf. 72
L254	Taf. 73
L255 L256 L259	Taf. 74
L261 L266 L269 L270 L271 L272	Taf. 75
L273 L281 L282 L284 L285	Taf. 76
L291 L292 L294 L296	Taf. 77
L298 L299 L301	Taf. 78
L302	Taf. 79
L303 L306 L307 L308 L310 L312 L313	Taf. 80
L314 L315 L320 L321 L323	Taf. 81
L333 L337 L338	Taf. 82

L339 L340 L341 L342 L343 L346 L347	Taf. 83
L349 L350 L352	Taf. 84
L355 L356 L357 L359	Taf. 85
L360 L361	Taf. 86
L362 L363	Taf. 87
L364 L366 L367	Taf. 88
L368 L371 L373 L376 L379	Taf. 89
L380 L383 L386	Taf. 90
L387 L396 L398 L400 L405 L408 L411 L413 L416	Taf. 91
L417 L418	Taf. 92
L419 L420	Taf. 93
L421	Taf. 94
L422 L423 L424	Taf. 95
L431 L444 L446 L449 L452	Taf. 96
L454 L455 L457	Taf. 97
L468 L469 L479	Taf. 98
L481	Taf. 99
L482	Taf. 99 Taf. 100

L483	Taf. 100
L484 L485 / 486 / 488 / 489 / 490	Taf. 101
L487	Taf. 102
L488 L489	Taf. 101
L491 L492 L494 L498 L499	Taf. 103
L502 L504	Taf. 104
L507 L511 L512	Taf. 105
L513 L514 L516	Taf. 106
L517 L519	Taf. 107
L520	Taf. 108 Taf. 109 Taf. 110 Taf. 111 Taf. 112
L521 L522	Taf. 112
L523	Taf. 113
L526	Taf. 114
L527 L528	Taf. 115
L529 L530	Taf. 116
L531	Taf. 116 Taf. 117
L532 L533	Taf. 118
L534 L535	Taf. 119
L536	Taf. 120 Taf. 121
L539 L540 L542	Taf. 121
L544 L545 L547 L548	Taf. 122
L550 L551 L555 L557 L558 L560 L561 L564	Taf. 123

L567 L568 L569 L576	Taf. 124
L579	Taf. 125
L580 L583 L584	Taf. 126
L585	Taf. 127 Taf. 128
L586	Taf. 132
L587	Taf. 129
L590	Taf. 130 Taf. 131 Taf. 132
L591	Taf. 133
L596 L597	Taf. 134
L598 L493/599	Taf. 135
L601	Taf. 136 Taf. 137
L602	Taf. 137
L603	Taf. 138
L604 L614 L615 L620	Taf. 139
L621 L622	Taf. 140
L624 L627 L629 L634 L639	Taf. 140
L647	Taf. 141 Taf. 142
L649 L650 L653 L654	Taf. 143
j/61, Gru. 2	Taf. 144 Taf. 145 Taf. 146
k/58, M130 k/58, zw. M669 und M670 k/58, Gru. 1 k/58, Gru. 19 k/59, M674 k/59, M690	Taf. 147
k/59, Gru. 12 k/59, Gru. 18	Taf. 148
k/59, Gru. 22	Taf. 147
k/59-O, Gru. 7 k/59-O, Gru. 15	Taf. 147
k/59-O, Gru. 22	Taf. 149
k/59-60, Gru. 10	Taf. 149

k/60, Gru. 6	Taf. 150
k/60, Gru. 14 k/61, Profilgräben k/61, M618, Fgr. k/61, M144a k/61, Gru. 1	Taf. 151
k/61, Gru. 3 (=l/61, Gru. 1=l/62, gr. Störung)	Taf. 152
k/61, Gru. 4	Taf. 153
k/61, Gru. 11 l/59, M678/679/680 l/61, M153/156 l/61, M166 l/61, M182 l/61, U1	Taf. 154
l/61, Gru. 1 (=k/61, Gru. 3=l/62, gr. Störung)	Taf. 157
l/61, Gru. 9 l/61, Gru. 10 l/61, Gru. 13 l/61, Gru. 22	Taf. 154
l/61, Gru. 23	Taf. 155
l/61, Gru. 31	Taf. 156 Taf. 157
l/61, Gru. 32 l/61, Gru. 35-40, 43	Taf. 155
l/62, gr. Störung (=k/61, Gru. 3 = l/61, Gru. 1)	Taf. 158
m/57, Gru. 2 m/58, M207/211/213 m/58, Gru. 2 m/58, Gru. 3 m/58, Gru. 14	Taf. 159

m/59, Schnitt am O-Profil m/60, M686/687/688 m/61, M248 m/61, M249 m/61, M265 m/61, M604/606 m/61, Gru. Im S-Profil	Taf. 160
m/61, Gru. 1	Taf. 161 Taf. 162
m/61, Gru. 2	Taf. 163
m/61, Gru. 3	Taf. 164 Taf. 165
m/61, Gru. 4	Taf. 165
m/61, Gru. 5 m/61, Gru. 6 m/61, Gru. 7	Taf. 166
m/62, M241 m/62, M242 m/62, M263 m/62, M302 m/62, M630 m/62, Mauern str. d (?)	Taf. 167
m/62, ganzes Plq. str. e/4 – f	Taf. 168
m/62, Gru. 1	Taf. 169
m/62, Gru. 2 m/62, Gru. 4	Taf. 170
m/62, Gru. 17 m/62, O-Profil n/58; Gru. 16 n/58, Gru. 19 n/59, M418/420/421 n/59, Gru. 5 n/59, Gru. 6 n/59, Gru. 9	Taf. 171

n/59, Gru. 18; n/60, M410/413 n/60, M533 n/60, Gru. 5	Taf. 172
n/60, Gru. 10 n/60, Gru. 11 n/60, Gru. 14	Taf. 173
n/61, M457 n/61, M589-594, 599	Taf. 174
n/61, Gru. 1 n/61, Gru. 2 n/61, Gru. 3 n/61, Gru. 5	Taf. 175
n/62, M596 n/62, Mauern str. c und b o/59, M519/520 o/59, M513/514/521/560 o/59, M545	Taf. 176
o/59, M554-561 o/59, zw. M561 und M547 o/59, M567	Taf. 177
o/59, Mauern str. c o/59, Mauern str. e/1 o/59, Mauern str. e/2	Taf. 178
o/59, Gru. 1 o/59, Gru. 2	Taf. 179
o/59, Gru. 5 o/59, Gru. 8	Taf. 180
o/59, Gru. 9 o/59, Gru. 10 o/59, Gru. 11 o/59, Gru. 12 o/59, Gru. 18	Taf. 181
o/59, Gru. 22 o/59, Gru. 25	Taf. 182



## KONKORDANZ ZWISCHEN ABBILDUNGEN UND TAFELN, NACH TAFELN GEORDNET

Tafel	TD-Inv. Nr.	Abb.
001	8556X	T17
001	8557A	T17
001	8557F	
001	8557G	
001	8565A	T40
001	8617G	T125
001	8617H	T125
001	8897P	T40
001	8898C	T40
001	8926A1	T120
001	8926A2	T120
001	8926B	T120
001	8926C	T120
002	8557J	
002	8559M	T88
002	8620	T90
002	8906J	T22
002	8906K	T11
002	8906Y	T58
002	8976O	T162
002	8976P	T162
003	8569I	T58
003	8594	T111
003	8620D	T57
003	8886K	T84
003	8886S	T56
003	8887L	T10
003	8897Q	T56
004	8887N	T9
004	8887Q	T45
004	8888J	T63
004	8904S	T9
004	8904T	T9
004	8906Q	T63
005	8569H	T101
005	8617J1	T63
005	8617J2	T63
005	8617J3	T63
005	8619B	T67
005	8975D	K2
006	8575	K12
006	8618W	T125
006	8618X	T125
006	8618Y	T125
006	8618Z	T125

Tafel	TD-Inv. Nr.	Abb.
006	8974A	T138
006	8974B	T131
006	8974C	K2
006	8974M	K2
006	8974N	K2
006	8974O	K2
006	8974P	K2
006	8974Q	K2
006	8975F	K2
006	8975G	K2
007	8574	K12
007	8576	K12
007	8609	K12
007	8949S	K13
008	8892R	T39
008	8900A	T107
008	8975O	T160
009	8556J	T14
009	8557T	T14
009	8557W	
009	8976B	T156
009	8976F/a-f	T161
009	8976F/g	T165
009	8976F/h	T137
010	8886O	T14
010	8898Z	T107
010	8949E	T153
010	8950A	T131
010	8950I	T131
010	8950J	T131
010	8950L	T131
010	8950O	T131
010	8950P	T131
014	8555J	T14
014	8555K	T14
014	8556C	T14
014	8556M	
014	8557R	T14
014	8565D	T41
014	8888O	T14
014	8898O	T41
014	8902B	T14
014	8950D	T131
014	8976R	T162
016	8888N	T14

Tafel	TD-Inv. Nr.	Abb.
016	8889A	T122
016	8889B	T120
017	8617Y	T113
017	8905O	T108
017	8907R	T23
018	8617X	T113
018	8643P	T23
018	8977P	T164
019	8950T	T131
020	8556R	T18
020	8885W	T23
020	8977H	T164
020	9504Z	T168
020/024	8558N	T122
022	8558M	T111
022	8561	T153
022	8885X	T23
022	8928E	T22
022	8949N	T154
022	8976Y	T164
023	8975Q	T160
023	8975R	T160
023	8975S	T160
023	8975T/a-d	T160
023	8975U	
024	8569J	T109
024	8569L	T13
024	8620Z	T111
024	8907K	T106
025	8557C	T17
025	8565Z	T80
025	8886J	T102
025	8886W	T23
025	8975W	T165
027	8565L	T8
027	8617L	T54
027	8617Z	T113
027	8885Y	T3
027	8976S	T165
028	8557V	T8
028	8558F	T9
028	8569G	T130
028	8898U	T36
028	8898Y	T85
028	8899A	T42

Tafel	TD-Inv. Nr.	Abb.
028	8913M	T98
028	8950K	T131
028	8973X	T140
029	8926D	
029	8949Q	T136
029	8974V	K2
029	8974W	K2
029	8974X	K2
029	8974Y	K2
029	8974Z	K2
032	8618A	T84
032	8618E	T50
032	8949U	T131
032	8977C	T163
037	8567A	T150
037	8889H	T15
037	8892M	T15
037	8892P	T111
037	8897J	T15
037	8897K	T55
037	8898K	T2
037	8902D	T63
039	8558B	T16
039	8974D	K2
039	8974E	K2
039	8974F	K2
039	8974G	K14
039	8974H	K2
040	8610	K1
040	8617V	T113
041	8906N	T4
041	8949C	T153
042	8897F	T13
042	8974R	K1
042	8974S	K1
042	8975E	K1
042	8975I	K1
042	8975J	K1
042	8975K	K1
042	8976D	K14
042	8976I	K1
043	8599	T17
043	8885J	T98
045	8559P	T76
045	8618B	T72
045	8619C	T113
045	8620L	T14

Tafel	TD-Inv. Nr.	Abb.
045	8620M	T14
045	8899H	T35
045	8899X	T14
047	8616N	T38
047	8618J	T76
047	8618U	T113
047	8618V	T113
047	8643W	T14
047	8643X	T14
047	8897M	T57
047	8897U	T57
047	8899Q	T40
048	8643U	T15
048	8915A	T136
048	8973S	T144
049	8579	T14
049	8580	T14
049	8581	T14
049	8582	T14
049	8583	T14
049	8584	T4
049	8585	T14
049	8586	T18
049	8643F	T18
049	8885F	T52
049	8885G	T14
049	8885K	T53
049	8888Q	T14
049	8888X	T14
049	8892L	T14
049	8897I	T19
049	8897T	T37
050	8977L/a	T165
050	8977L/b	T163
050/103	8977D	T163
052	8620N	T11
052	8620S	T98
052	8643J	T11
052	8886T	T57
052	8886X	T101
053	8570	T149
053	8571	T149
053	8617W	T71
053	8619	T88
053	8888S	T111
054	8567	T149
054	8888G	T63

Tafel	TD-Inv. Nr.	Abb.
054	8888P	T10
054	8899L	T19
055	8577M	T10
055	8617U	T23
055	8643Y	T10
055	8888T	T36
055	8906T	T49
056	8643S	T38
056	8643T	T10
056	8897N	T56
059	8618I	T39
060	8572	T149
060	8618C	T4
060	8618K	T18
060	8619A	T113
060	8899N	T1
060	8906Z	T39
061	8577	T63
061	8620H	T10
061	8620Q	T111
061	8620U	T111
061	8885H	T98
061	8888R	T10
061	8888V	T10
061	8888W	T10
061	8888Y	T10
061	8899O	T1
061	8907M	T33
061	8950F	T134
062	8578	T10
062	8620V	T63
062	8907N	T33
064	8616	K1
064	8617E	T113
064	8886Y	T113
064	8974I	K1
064	8974J	K1
064	8974K	K1
064	8974L a,b	K1
065	8569F	T53
065	8620O	T63
065	8620R	T111
065	8643C	T12
065	8643K	T99
065	8887W	T63
065	8898R	T53
065	8900P	T37

Tafel	TD-Inv. Nr.	Abb.
065	8949J	T152
065	8949P	T136
065	8950Z	T151
068	8598	T11
068	8617B	T113
068	8617C	T113
068	8617C2	T113
068	8620T	
068	8887Z	T11
068	8898P	T48
068	8898W	T11
068	8904Z	T12
068	8973W	T143
069	8565I	T103
069	8597	T15
069	8620K	T12
069	8620P	T111
069	8885C	T105
069	8888F	T63
069	8949R	T154
070	8593	T39
070	8603	T39
070	8604	T4
070	8605	T10
070	8617M	T22
070	8617N	T36
070	8617O	T36
070	8620X	T45
070	8890B	T10
070	8890F	T10
070	8890V	T10
070	8890W	T10
070	8891R	T10
070	8891T	T22
070	8891W	T10
071	8592	T52
071	8617P	T35
071	8617Q	T34
071	8617R	
071	8617S	
071	8617T	T10
071	8643M	T4
071	8888B	T10
071	8892N	T36
071	8892S	T58
071	8898Q	T64
071	8898S	T106

Tafel	TD-Inv. Nr.	Abb.
071	8898T	T106
072	8601	T111
072	8902C	T13
072	8950U	T152
073	8569B	T72
073	8573	T150
073	8587	T19
073	8602	T39
073	8608	T13
073	8643B	T13
073	8643L	T13
073	8898I	T42
074	8973Y	T144
075	8595	T21
075	8620J	T8
075	8977U	T154
076	8618D	T18
076	8618H	T47
076	8643E	T9
076	8643G	T9
076	8643H	T9
076	8885E	T9
076	8890Z	T12
076	8892O	T35
076	8892X	T56
078	8618F	T23
078	8643N	T18
078	8886L	T86
078	8886Q	T18
078	8887G	T9
078	8900U	T94
080	8617A	T113
080	8889J	T9
080	8890D	T9
080	8890P	T23
080	8891S	T9
080	8897X	T56
080	8904M	T9
080	8906F	T21
080	8906V	T35
080	8907E	T2
080	8907F	T84
080	8950M	T131
081	8904N	T9
082	8890T	T10
082	8891Y	T4
082	8899F	T2

Tafel	TD-Inv. Nr.	Abb.
083	8890H	T99
083	8890Q	T99
083	8897L	T56
083	8907T	T109
083	8949F	T153
084	8887U	T3
084	8889C	T113
084	8890A	T8
084	8891X	T8
084	8899P	T104
085	8900L	T99
085	8900M	T99
085	8900N	T99
085	8900O	T111
085	8949H	K14
087	8888D	T12
087	8889G	T12
087	8889L	T18
087	8889N	T63
087	8889O	T12
087	8889W	T12
087	8890E	T63
087	8890R	T3
087	8890X	T22
087	8890Y	T12
087	8900J	T12
087	8949A	T165
087	8976M	T161
087	8976N	T161
088	8618G	T49
088	8887H	T39
088	8887J	T41
088	8889Q	T1
088	8900H	T1
088	8902E	
089	8889U	T11
089	8890O	T15
089	8890S	T1
090	8617	T65
090	8886C	T36
090	8887R	T46
090	8888C	T9
090	8905K	T73
091	8618L	T22
091	8887K	T39
091	8888Z	T46
091	8889E	T8

Tafel	TD-Inv. Nr.	Abb.
091	8889P	T1
091	8889R	T8
091	8889S	T8
091	8889T	T8
091	8889Y	T8
091	8891V	T8
091	8891Z	T8
091	8907H	T4
091	8977B	T163
092/182	8643R	T44
093	8899K	T63
093	8949G	T151
093	8949K	K14
094	8900W	T10
094	8900X	T111
094	8949O	T154
095	8612	T98
095	8899S	T1
095	8943F	T4
096	8927W	T33
097	8889Z	T9
097	8899J	T63
098	8898M	T48
098	8927Y	T71
100	8565E	T55
100	8899G	T55
100	8905A	T15
100	8973T	T140
100	8974T	K2
100	8976Z/a-b	T163
102	8885L	T13
102	8885M	
102	8885N	T13
102	8885O	T13
102	8885P	T13
102	8885Q	
102	8885R	T13
102	8898N	T107
102	8907Q	T105
102	8907S	T84
102	8913H	T13
102	8976Q	T162
103	8557M	T10
103	8557N	T10
103	8557O	T10
103	8558R	T1
103	8558S	T1

Tafel	TD-Inv. Nr.	Abb.
103	8887S	T38
103	8950Q	T140
104	8557P	T12
104	8557S	T11
104	8557U	T12
104	8557Y	T12
104	8557Z	T12
104	8558E	
104	8886M	T33
104	8897V	T57
104	8898J	T44
104	8899U	T48
105	8556G	T13
105	8569O	T74
105	8618Q	T113
105	8905R	T12
105	8907O	T129
105	8913K	T12
105	8977I	T164
107	8569X	T100
107	8569Y	T100
107	8569Z1	T100
107	8569Z2	T100
107	8577A	T100
107	8577B1	T100
107	8577B2	T100
107	8577C1	T100
107	8577C2	T100
107	8577D	T100
107	8577E	T100
107	8643A	T100
111	8555Y	T17
111	8555Z	T17
111	8556L	T17
111	8556V	T17
111	8559T	T122
111	8559U	
111	8569K	T109
111	8900Y	T122
111	8928B	T23
111	8950W	T152
112	8565S	T21
112	8596	T109
112	8913L	T13
112	8976U	T162
112	8976V	T162
113	8976C	T156

Tafel	TD-Inv. Nr.	Abb.
114	8556H	T9
114	8558C	T9
114	8558D	T9
114	8577L	T113
115	8496	T149
115	8555G	T38
115	8556A	T11
115	8556Z	T10
115	8565B	T1
115	8569N	T45
115	8617K	T37
115	8886E	T57
115	8898H	T2
115	8904W	T10
115	8905P	T47
115	8907J	T22
115	8915	T151
116	8555H	T100
116	8618T	T125
117	8554L	T52
117	8554M	T52
117	8554O	T52
117	8555	T52
117	8556S	T11
117	8886G	T58
117	8886R	T57
117	8928H	T33
117	8950S	T131
118	8915B	T131
118	8950G	T131
118	8977G	T164
119	8559Q	T113
119	8565M	T12
121	8555U	T16
121	8555V	
121	8559H	T98
121	8565W	T33
121	8565X	T73
121	8898B	T37
121	8977Q	T164
122	8620W	T33
122	8892T	T56
122	8898A	T36
122	8898G	T58
122	8950E	T131
122/167	8565F	T100
123	8557Q	T17



Tafel	TD-Inv. Nr.	Abb.
123	8558Y	T63
123	8559	T4
123	8618R	T69
123	8886U	T43
123	8905C	T1
123	8905E	T78
123	8905F	T71
123	8905V	T41
124	8556B	T12
124	8556F	T18
124	8556U	T10
124	8558X	T63
124	8892U	T57
124	8904V	
124	8904X	
124	8905G	T33
125	8556T	T11
125	8565G	T1
125	8565H	T11
125	8565J	T11
125	8565K	T11
125	8900K	T57
126	8559S	T122
126	8928D	T21
126	8928G	T17
128	8558L	T63
128	8565Q	T98
128	8569C	T54
128	8885T	T63
128	8885U	T63
128	8885Z	T19
128	8913N	T111
128	8927X	T50
128	8928F	T1
128	8975X	T155
128	8975Z	T155
128	8976A	T156
129	8556Y	T12
129	8558J	T1
129	8558Q	
129	8559V	T125
132	8569D	T41
132	8897S	T57
132	8900C	T42
132	8975M	T144
133	8556W	T11
133	8558K	T44

Tafel	TD-Inv. Nr.	Abb.
133	8558O	T19
133	8559R	T122
133	8928C	T3
133	8973R	T139
133	8975Y	T155
134	8905D	T3
134	8907L	T129
135	8931K	T134
137	8558W	T15
137	8558Z	T15
137	8905H	T100
137	8905L	T106b
137	8949I	T105
138	8904Y	T15
138	8905J	T100
138	8905M	T111
138	8976X	T162
139	8500H	T125
139	8898L	T36
139	8904L	T9
139	8906C	T8
139	8906G	T23
139	8906R	T63
139	8907D	T106
139	8907W	T13
139	8950H	T131
139	8975A	K2
139	8975B	K2
139	8975C	K2
139	8977M	T164
140	8564C	T78
140	8885S	T9
140	8887O	T23
140	8906B	T9
140	8907A	T38
140	8907G	T71
140	8915C	K2
140	9057Y	T113
142	8559J	T83
142	8588	T11
142	8589	T11
142	8590	T12
142	8591	T11
142	8611	T76
142	8888E	T22
142	8888K	T11
142	8888L	T11

Tafel	TD-Inv. Nr.	Abb.
142	8888M	T12
142	8892W	T58
142	8897Z	T49
142	8898D	T45
142	8913F	T22
142	8913J	T11
143	8887Y	
144	8565N	T16
144	8565O	T16
144	8565P	T16
145	8927T	T120
145	8927U	T120
146	8554P	T39
146	8554Q	T16
146	8554R	T16
146	8554X	T16
146	8565Y	T33
146	8892V	T58
146	8892Y	T58
146	8929	T150
147	8558T	T100
147	8569M	T18
147	8620G	T46
147	8888U	T8
147	8892Z	T107
147	8898V	T37
147	8900S	T1
147	8976W	T162
148	8620Y	T111
148	8886P	T9
148	8889F	T9
148	8889K	T9
148	8890C	T9
148	8890G	T99
148	8899M	T47
148	8900T	T1
148	8913O	T1
149	8643Z	T8
149	8888A	T23
149	8889D	T8
149	8889M	T8
149	8889X	T8
149	8890J	T23
149	8890K	T23
149	8890N	T8
149	8891U	T63
149	8904O	T8

Tafel	TD-Inv. Nr.	Abb.
149	8904P	T8
149	8904Q	T8
149	8904R	T8
149	8906M	T23
149	8906P	T105
149	8907B	
149	8950B	T137
149	8950C	T131
149	8950Y	T138
149	8977O	T164
150	8606	T52
150	8607	T52
150	8620E	T102
150	8900I	T52
150	8900R	T106
150	8906W	T4
150	8906X	T44
150	8907C	T41
151	8557B	T13
151	8569T/1	T106b
151	8569T/2	T106b
151	8618	T90
153	8906L	T69
153	8906O	T63
154	8892Q	T1
154	8897G	T15
154	8897H	T10
154	8897O	T56
154	8906D	T8
154	8906S	T63
154	8907V	
155	8608A	T54
155	8892I	T8
155	8892J	T8
155	8899D	T41
155	8950N	T131
155	8977T	T165
157	8898X	T58
157	8906E	T22
157	8906H	T23
158	8907X	T111
159	8565R	T76
159	8577F1	T99
159	8577F2	T99
159	8577G	T99
159	8577H1	T99
159	8577H2	T99

Tafel	TD-Inv. Nr.	Abb.
159	8577I	T111
159	8577J1	T99
159	8577J2	T99
159	8577K1	T99
159	8577K2	T99
159	8890L	T15
159	8890M	T15
159	8899Z	T10
160	8558A	T16
160	8618P	T113
160	8887T	T111
160	8900B	T48
160	8905T	T2
161	8949M	T129
161	8977K	T165
162	8494O	T56
162	8555D	T16
162	8555E	
162	8555L	T16
162	8555M	T16
162	8555Q	T16
162	8555X	T16
162	8556D	T18
162	8556E	T16
162	8556P	T16
162	8556Q	
162	8557D	
162	8557E	
162	8557K	
162	8557L	
162	8557X	T16
162	8558P	T21
162	8569E	T63
162	8898E	T106
162	8898F	T62
162	8899Y	
162	8905B	T63
162	8905N	T53
162	8905Q	T2
163	8913S	T106b
165	8555F	T106
165	8555O	T16
165	8617F	T125
165	8907P	T129
165	8913P	T50
166	8555R	T16
166	8555S	

Tafel	TD-Inv. Nr.	Abb.
166	8556O	T52
166	8559K	T72
166	8905S	T43
166	8913Q	T106
166	8913R	T106
167	8569V1	T99
167	8569V2	T99
167	8569W1	T99
167	8569W2	T99
167	8569W3	T99
167	8569W4	T99
167	8569W5	T99
167	8888H	T63
167	8950X	T136
167	8973V	T143
168	8569U	T66
169	8555P	T16
169	8555T	T37
169	8569S	T3
169	8897W	T105
169	8928A	T120
169	9145B	T120
169	9145C	T125
170	8555W	
170	8565T	T108
170	8565U	T108
170	8565V	T50
171	8643Q	T10
171	8886D	T56
171	8886F	T58
171	8886H	T102
171	8892K	T11
172	8643V	T15
172	8887M	T13
173	8618M	T22
173	8886N	T8
173	8897Y	T44
174	8558G	T9
174	8565C	T1
174	8902F	T99
174	8902G	T99
175	8559L	T77
176	8569P	T57
176	8885A	T19
176	8885B	T13
176	8887X	T63
176	8899C	T42

Tafel	TD-Inv. Nr.	Abb.
176	8899T	T12
176	8899W	T15
176	8900D	T63
176	8913G	T14
177	8977J	T163
179	8569	T76
179	8569R	T40
179	8900F	T79
180	8902A	
181	8600	T14
181	8618O	T55
181	8643D	T1
181	8643O	T35
181	8885D	T13
181	8890U	T13
181	8900E	T1
181	8900G	T1
182	8620F	T54
182	8899R	T34
183	8558U	T106
183	8558V	T106
183	8620A	T125
183	8620B	T125
183	8620C	T125
183	8897R	T57
183	8900Q	T107

Keine Tafelabbildung	TD-Inv. Nr.	Abb.
Skarabäus (m/62, M605)	8560	T150
Krüglein ( j/60, Grab 1)	8565	T120
Skarabäus (L118)	8566	T149
LPW (L234)	8617D	T115
PTY (k/59, Störung)	8618S	T120
Kupfernadel (L600)	8949B	T153
Tonfigur (L415)	8949L	T129
Steinschale (m/58, M198)	8950R	T131
Fayenceperle, k/61, Grab 5	8950V	T152
Kalksteinplatte (n/58, Gru. 7)	8973Z	T148
Polierstein (o/59, Gru. 11)	8975L	T160
Kalksteinobjekt (L229)	8975N	T137
Diorithammer (j/61, M568)	8975P	T165
Klopfstein (L39)	8975V/a-b	T164
Geglätteter Stein (L20)	8976E	K14
Bohrerkappe? (kein Kontext)	8976G	T137
Relieffragment (kein Kontext)	8976H	K1
Rundstab (kein Kontext)	8976K	T148
Relieffragment (kein Kontext)	8976L	K2
Reibstein (L509)	8976T	T162
Schleifstein (L354)	8977A	T163
Polierstein (kein Kontext)	8977E	T163
Klopfstein (k/61, U1)	8977F	T164
Schleifstein (L375)	8977N	T164
Klopfstein (m/58, M198)	8977S	T164
LPW (L263)	9057X	T113
Kupfernadel (l/m-59/60, M683)	8949D	T153
Kalksteinrelief (l/m-59/60, M683)	8975H	K2

## KONKORDANZ ZWISCHEN ABBILDUNGEN UND TAFELN, NACH INV. NR. GEORDNET

TD-Inv. Nr.	Abb.	Tafel
8494O	T56	162
8496	T149	115
8500H	T125	139
8554L	T52	117
8554M	T52	117
8554O	T52	117
8554P	T39	146
8554Q	T16	146
8554R	T16	146
8554X	T16	146
8555	T52	117
8555D	T16	162
8555E		162
8555F	T106	165
8555G	T38	115
8555H	T100	116
8555J	T14	014
8555K	T14	014
8555L	T16	162
8555M	T16	162
8555O	T16	165
8555P	T16	169
8555Q	T16	162
8555R	T16	166
8555S		166
8555T	T37	169
8555U	T16	121
8555V		121
8555W		170
8555X	T16	162
8555Y	T17	111
8555Z	T17	111
8556A	T11	115
8556B	T12	124
8556C	T14	014
8556D	T18	162
8556E	T16	162
8556F	T18	124
8556G	T13	105
8556H	T9	114
8556J	T14	009
8556L	T17	111
8556M		014
8556O	T52	166
8556P	T16	162
8556Q		162
8556R	T18	020
8556S	T11	117
8556T	T11	125

TD-Inv. Nr.	Abb.	Tafel
8556U	T10	124
8556V	T17	111
8556W	T11	133
8556X	T17	001
8556Y	T12	129
8556Z	T10	115
8557A	T17	001
8557B	T13	151
8557C	T17	025
8557D		162
8557E		162
8557F		001
8557G		001
8557J		002
8557K		162
8557L		162
8557M	T10	103
8557N	T10	103
8557O	T10	103
8557P	T12	104
8557Q	T17	123
8557R	T14	014
8557S	T11	104
8557T	T14	009
8557U	T12	104
8557V	T8	028
8557W		009
8557X	T16	162
8557Y	T12	104
8557Z	T12	104
8558A	T16	160
8558B	T16	039
8558C	T9	114
8558D	T9	114
8558E		104
8558F	T9	028
8558G	T9	174
8558J	T1	129
8558K	T44	133
8558L	T63	128
8558M	T111	022
8558N	T122	020/024
8558O	T19	133
8558P	T21	162
8558Q		129
8558R	T1	103
8558S	T1	103
8558T	T100	147
8558U	T106	183

TD-Inv. Nr.	Abb.	Tafel
8558V	T106	183
8558W	T15	137
8558X	T63	124
8558Y	T63	123
8558Z	T15	137
8559	T4	123
8559H	T98	121
8559J	T83	142
8559K	T72	166
8559L	T77	175
8559M	T88	002
8559P	T76	045
8559Q	T113	119
8559R	T122	133
8559S	T122	126
8559T	T122	111
8559U		111
8559V	T125	129
8560	T150	Keine Tafelabbildung: Skarabäus (m/62, M605)
8561	T153	022
8564C	T78	140
8565	T120	s. j/60, Grab 1
8565A	T40	001
8565B	T1	115
8565C	T1	174
8565D	T41	014
8565E	T55	100
8565F	T100	122/167
8565G	T1	125
8565H	T11	125
8565I	T103	069
8565J	T11	125
8565K	T11	125
8565L	T8	027
8565M	T12	119
8565N	T16	144
8565O	T16	144
8565P	T16	144
8565Q	T98	128
8565R	T76	159
8565S	T21	112
8565T	T108	170
8565U	T108	170
8565V	T50	170
8565W	T33	121
8565X	T73	121
8565Y	T33	146
8565Z	T80	025
8566	T149	Keine Tafelabbildung: Skarabäus (L118)
8567	T149	054

TD-Inv. Nr.	Abb.	Tafel
8567A	T150	037
8569	T76	179
8569B	T72	073
8569C	T54	128
8569D	T41	132
8569E	T63	162
8569F	T53	065
8569G	T130	028
8569H	T101	005
8569I	T58	003
8569J	T109	024
8569K	T109	111
8569L	T13	024
8569M	T18	147
8569N	T45	115
8569O	T74	105
8569P	T57	176
8569R	T40	179
8569S	T3	169
8569T/1	T106b	151
8569T/2	T106b	151
8569U	T66	168
8569V1	T99	167
8569V2	T99	167
8569W1	T99	167
8569W2	T99	167
8569W3	T99	167
8569W4	T99	167
8569W5	T99	167
8569X	T100	107
8569Y	T100	107
8569Z1	T100	107
8569Z2	T100	107
8570	T149	053
8571	T149	053
8572	T149	060
8573	T150	073
8574	K12	007
8575	K12	006
8576	K12	007
8577	T63	061
8577A	T100	107
8577B1	T100	107
8577B2	T100	107
8577C1	T100	107
8577C2	T100	107
8577D	T100	107
8577E	T100	107
8577F1	T99	159
8577F2	T99	159
8577G	T99	159
8577H1	T99	159

TD-Inv. Nr.	Abb.	Tafel
8577H2	T99	159
8577I	T111	159
8577J1	T99	159
8577J2	T99	159
8577K1	T99	159
8577K2	T99	159
8577L	T113	114
8577M	T10	055
8578	T10	062
8579	T14	049
8580	T14	049
8581	T14	049
8582	T14	049
8583	T14	049
8584	T4	049
8585	T14	049
8586	T18	049
8587	T19	073
8588	T11	142
8589	T11	142
8590	T12	142
8591	T11	142
8592	T52	071
8593	T39	070
8594	T111	003
8595	T21	075
8596	T109	112
8597	T15	069
8598	T11	068
8599	T17	043
8600	T14	181
8601	T111	072
8602	T39	073
8603	T39	070
8604	T4	070
8605	T10	070
8606	T52	150
8607	T52	150
8608	T13	073
8608A	T54	155
8609	K12	007
8610	K1	040
8611	T76	142
8612	T98	095
8616	K1	064
8616N	T38	047
8617	T65	090
8617A	T113	080
8617B	T113	068
8617C	T113	068
8617C2	T113	068
8617D	T115	Keine Tafelabbildung: LPW (L234)

TD-Inv. Nr.	Abb.	Tafel
8617E	T113	064
8617F	T125	165
8617G	T125	001
8617H	T125	001
8617J1	T63	005
8617J2	T63	005
8617J3	T63	005
8617K	T37	115
8617L	T54	027
8617M	T22	070
8617N	T36	070
8617O	T36	070
8617P	T35	071
8617Q	T34	071
8617R		071
8617S		071
8617T	T10	071
8617U	T23	055
8617V	T113	040
8617W	T71	053
8617X	T113	018
8617Y	T113	017
8617Z	T113	027
8618	T90	151
8618A	T84	032
8618B	T72	045
8618C	T4	060
8618D	T18	076
8618E	T50	032
8618F	T23	078
8618G	T49	088
8618H	T47	076
8618I	T39	059
8618J	T76	047
8618K	T18	060
8618L	T22	091
8618M	T22	173
8618O	T55	181
8618P	T113	160
8618Q	T113	105
8618R	T69	123
8618S	T120	Keine Tafelabbildung: PTY (k/59, Störung)
8618T	T125	116
8618U	T113	047
8618V	T113	047
8618W	T125	006
8618X	T125	006
8618Y	T125	006
8618Z	T125	006
8619	T88	053
8619A	T113	060

TD-Inv. Nr.	Abb.	Tafel
8619B	T67	005
8619C	T113	045
8620	T90	002
8620A	T125	183
8620B	T125	183
8620C	T125	183
8620D	T57	003
8620E	T102	150
8620F	T54	182
8620G	T46	147
8620H	T10	061
8620J	T8	075
8620K	T12	069
8620L	T14	045
8620M	T14	045
8620N	T11	052
8620O	T63	065
8620P	T111	069
8620Q	T111	061
8620R	T111	065
8620S	T98	052
8620T		068
8620U	T111	061
8620V	T63	062
8620W	T33	122
8620X	T45	070
8620Y	T111	148
8620Z	T111	024
8643A	T100	107
8643B	T13	073
8643C	T12	065
8643D	T1	181
8643E	T9	076
8643F	T18	049
8643G	T9	076
8643H	T9	076
8643J	T11	052
8643K	T99	065
8643L	T13	073
8643M	T4	071
8643N	T18	078
8643O	T35	181
8643P	T23	018
8643Q	T10	171
8643R	T44	092/182
8643S	T38	056
8643T	T10	056
8643U	T15	048
8643V	T15	172
8643W	T14	047
8643X	T14	047
8643Y	T10	055

TD-Inv. Nr.	Abb.	Tafel
8643Z	T8	149
8885A	T19	176
8885B	T13	176
8885C	T105	069
8885D	T13	181
8885E	T9	076
8885F	T52	049
8885G	T14	049
8885H	T98	061
8885J	T98	043
8885K	T53	049
8885L	T13	102
8885M		102
8885N	T13	102
8885O	T13	102
8885P	T13	102
8885Q		102
8885R	T13	102
8885S	T9	140
8885T	T63	128
8885U	T63	128
8885W	T23	020
8885X	T23	022
8885Y	T3	027
8885Z	T19	128
8886C	T36	090
8886D	T56	171
8886E	T57	115
8886F	T58	171
8886G	T58	117
8886H	T102	171
8886J	T102	025
8886K	T84	003
8886L	T86	078
8886M	T33	104
8886N	T8	173
8886O	T14	010
8886P	T9	148
8886Q	T18	078
8886R	T57	117
8886S	T56	003
8886T	T57	052
8886U	T43	123
8886W	T23	025
8886X	T101	052
8886Y	T113	064
8887G	T9	078
8887H	T39	088
8887J	T41	088
8887K	T39	091
8887L	T10	003
8887M	T13	172

TD-Inv. Nr.	Abb.	Tafel
8887N	T9	004
8887O	T23	140
8887Q	T45	004
8887R	T46	090
8887S	T38	103
8887T	T111	160
8887U	T3	084
8887W	T63	065
8887X	T63	176
8887Y		143
8887Z	T11	068
8888A	T23	149
8888B	T10	071
8888C	T9	090
8888D	T12	087
8888E	T22	142
8888F	T63	069
8888G	T63	054
8888H	T63	167
8888J	T63	004
8888K	T11	142
8888L	T11	142
8888M	T12	142
8888N	T14	016
8888O	T14	014
8888P	T10	054
8888Q	T14	049
8888R	T10	061
8888S	T111	053
8888T	T36	055
8888U	T8	147
8888V	T10	061
8888W	T10	061
8888X	T14	049
8888Y	T10	061
8888Z	T46	091
8889A	T122	016
8889B	T120	016
8889C	T113	084
8889D	T8	149
8889E	T8	091
8889F	T9	148
8889G	T12	087
8889H	T15	037
8889J	T9	080
8889K	T9	148
8889L	T18	087
8889M	T8	149
8889N	T63	087
8889O	T12	087
8889P	T1	091
8889Q	T1	088

TD-Inv. Nr.	Abb.	Tafel
8889R	T8	091
8889S	T8	091
8889T	T8	091
8889U	T11	089
8889W	T12	087
8889X	T8	149
8889Y	T8	091
8889Z	T9	097
8890A	T8	084
8890B	T10	070
8890C	T9	148
8890D	T9	080
8890E	T63	087
8890F	T10	070
8890G	T99	148
8890H	T99	083
8890J	T23	149
8890K	T23	149
8890L	T15	159
8890M	T15	159
8890N	T8	149
8890O	T15	089
8890P	T23	080
8890Q	T99	083
8890R	T3	087
8890S	T1	089
8890T	T10	082
8890U	T13	181
8890V	T10	070
8890W	T10	070
8890X	T22	087
8890Y	T12	087
8890Z	T12	076
8891R	T10	070
8891S	T9	080
8891T	T22	070
8891U	T63	149
8891V	T8	091
8891W	T10	070
8891X	T8	084
8891Y	T4	082
8891Z	T8	091
8892I	T8	155
8892J	T8	155
8892K	T11	171
8892L	T14	049
8892M	T15	037
8892N	T36	071
8892O	T35	076
8892P	T111	037
8892Q	T1	154
8892R	T39	008



TD-Inv. Nr.	Abb.	Tafel
8892S	T58	071
8892T	T56	122
8892U	T57	124
8892V	T58	146
8892W	T58	142
8892X	T56	076
8892Y	T58	146
8892Z	T107	147
8897F	T13	042
8897G	T15	154
8897H	T10	154
8897I	T19	049
8897J	T15	037
8897K	T55	037
8897L	T56	083
8897M	T57	047
8897N	T56	056
8897O	T56	154
8897P	T40	001
8897Q	T56	003
8897R	T57	183
8897S	T57	132
8897T	T37	049
8897U	T57	047
8897V	T57	104
8897W	T105	169
8897X	T56	080
8897Y	T44	173
8897Z	T49	142
8898A	T36	122
8898B	T37	121
8898C	T40	001
8898D	T45	142
8898E	T106	162
8898F	T62	162
8898G	T58	122
8898H	T2	115
8898I	T42	073
8898J	T44	104
8898K	T2	037
8898L	T36	139
8898M	T48	098
8898N	T107	102
8898O	T41	014
8898P	T48	068
8898Q	T64	071
8898R	T53	065
8898S	T106	071
8898T	T106	071
8898U	T36	028
8898V	T37	147
8898W	T11	068

TD-Inv. Nr.	Abb.	Tafel
8898X	T58	157
8898Y	T85	028
8898Z	T107	010
8899A	T42	028
8899C	T42	176
8899D	T41	155
8899F	T2	082
8899G	T55	100
8899H	T35	045
8899J	T63	097
8899K	T63	093
8899L	T19	054
8899M	T47	148
8899N	T1	060
8899O	T1	061
8899P	T104	084
8899Q	T40	047
8899R	T34	182
8899S	T1	095
8899T	T12	176
8899U	T48	104
8899W	T15	176
8899X	T14	045
8899Y		162
8899Z	T10	159
8900A	T107	008
8900B	T48	160
8900C	T42	132
8900D	T63	176
8900E	T1	181
8900F	T79	179
8900G	T1	181
8900H	T1	088
8900I	T52	150
8900J	T12	087
8900K	T57	125
8900L	T99	085
8900M	T99	085
8900N	T99	085
8900O	T111	085
8900P	T37	065
8900Q	T107	183
8900R	T106	150
8900S	T1	147
8900T	T1	148
8900U	T94	078
8900W	T10	094
8900X	T111	094
8900Y	T122	111
8902A		180
8902B	T14	014
8902C	T13	072

TD-Inv. Nr.	Abb.	Tafel
8902D	T63	037
8902E		088
8902F	T99	174
8902G	T99	174
8904L	T9	139
8904M	T9	080
8904N	T9	081
8904O	T8	149
8904P	T8	149
8904Q	T8	149
8904R	T8	149
8904S	T9	004
8904T	T9	004
8904V		124
8904W	T10	115
8904X		124
8904Y	T15	138
8904Z	T12	068
8905A	T15	100
8905B	T63	162
8905C	T1	123
8905D	T3	134
8905E	T78	123
8905F	T71	123
8905G	T33	124
8905H	T100	137
8905J	T100	138
8905K	T73	090
8905L	T106b	137
8905M	T111	138
8905N	T53	162
8905O	T108	017
8905P	T47	115
8905Q	T2	162
8905R	T12	105
8905S	T43	166
8905T	T2	160
8905V	T41	123
8906B	T9	140
8906C	T8	139
8906D	T8	154
8906E	T22	157
8906F	T21	080
8906G	T23	139
8906H	T23	157
8906J	T22	002
8906K	T11	002
8906L	T69	153
8906M	T23	149
8906N	T4	041
8906O	T63	153
8906P	T105	149

TD-Inv. Nr.	Abb.	Tafel
8906Q	T63	004
8906R	T63	139
8906S	T63	154
8906T	T49	055
8906V	T35	080
8906W	T4	150
8906X	T44	150
8906Y	T58	002
8906Z	T39	060
8907A	T38	140
8907B		149
8907C	T41	150
8907D	T106	139
8907E	T2	080
8907F	T84	080
8907G	T71	140
8907H	T4	091
8907J	T22	115
8907K	T106	024
8907L	T129	134
8907M	T33	061
8907N	T33	062
8907O	T129	105
8907P	T129	165
8907Q	T105	102
8907R	T23	017
8907S	T84	102
8907T	T109	083
8907V		154
8907W	T13	139
8907X	T111	158
8913F	T22	142
8913G	T14	176
8913H	T13	102
8913J	T11	142
8913K	T12	105
8913L	T13	112
8913M	T98	028
8913N	T111	128
8913O	T1	148
8913P	T50	165
8913Q	T106	166
8913R	T106	166
8913S	T106b	163
8915	T151	115
8915A	T136	048
8915B	T131	118
8915C	K2	140
8926A1	T120	001
8926A2	T120	001
8926B	T120	001
8926C	T120	001

TD-Inv. Nr.	Abb.	Tafel
8926D		029
8927T	T120	145
8927U	T120	145
8927W	T33	096
8927X	T50	128
8927Y	T71	098
8928A	T120	169
8928B	T23	111
8928C	T3	133
8928D	T21	126
8928E	T22	022
8928F	T1	128
8928G	T17	126
8928H	T33	117
8929	T150	146
8931K	T134	135
8943F	T4	095
8949A	T165	087
8949B	T153	Keine Tafelabbildung: Kupfernadel (L600)
8949C	T153	041
8949D	T153	Keine Tafelabbildung: Kupfernadel (l/m-59/60, M683)
8949E	T153	010
8949F	T153	083
8949G	T151	093
8949H	K14	085
8949I	T105	137
8949J	T152	065
8949K	K14	093
8949L	T129	Keine Tafelabbildung: Tonfigur (L415)
8949M	T129	161
8949N	T154	022
8949O	T154	094
8949P	T136	065
8949Q	T136	029
8949R	T154	069
8949S	K13	007
8949U	T131	032
8950A	T131	010
8950B	T137	149
8950C	T131	149
8950D	T131	014
8950E	T131	122
8950F	T134	061
8950G	T131	118
8950H	T131	139
8950I	T131	010
8950J	T131	010
8950K	T131	028
8950L	T131	010

TD-Inv. Nr.	Abb.	Tafel
8950M	T131	080
8950N	T131	155
8950O	T131	010
8950P	T131	010
8950Q	T140	103
8950R	T131	Keine Tafelabbildung: Steinschale (m/58, M198)
8950S	T131	117
8950T	T131	019
8950U	T152	072
8950V	T152	Keine Tafelabbildung: Fayenceperle, k/61, Grab 5
8950W	T152	111
8950X	T136	167
8950Y	T138	149
8950Z	T151	065
8973R	T139	133
8973S	T144	048
8973T	T140	100
8973V	T143	167
8973W	T143	068
8973X	T140	028
8973Y	T144	074
8973Z	T148	Keine Tafelabbildung: Kalksteinplatte (n/58, Gru. 7)
8974A	T138	006
8974B	T131	006
8974C	K2	006
8974D	K2	039
8974E	K2	039
8974F	K2	039
8974G	K14	039
8974H	K2	039
8974I	K1	064
8974J	K1	064
8974K	K1	064
8974L a,b	K1	064
8974M	K2	006
8974N	K2	006
8974O	K2	006
8974P	K2	006
8974Q	K2	006
8974R	K1	042
8974S	K1	042
8974T	K2	100
8974V	K2	029
8974W	K2	029
8974X	K2	029
8974Y	K2	029
8974Z	K2	029
8975A	K2	139
8975B	K2	139

TD-Inv. Nr.	Abb.	Tafel
8975C	K2	139
8975D	K2	005
8975E	K1	042
8975F	K2	006
8975G	K2	006
8975H	K2	Keine Tafelabbildung: Kalksteinrelief (l/m-59/60, M683)
8975I	K1	042
8975J	K1	042
8975K	K1	042
8975L	T160	Keine Tafelabbildung: Polierstein (o/59, Gru. 11)
8975M	T144	132
8975N	T137	Keine Tafelabbildung: Kalksteinobjekt (L229)
8975O	T160	008
8975P	T165	Keine Tafelabbildung: Diorithammer (j/61, M568)
8975Q	T160	023
8975R	T160	023
8975S	T160	023
8975T/a-d	T160	023
8975U		023
8975V/a-b	T164	Keine Tafelabbildung: Klopstein (L39)
8975W	T165	025
8975X	T155	128
8975Y	T155	133
8975Z	T155	128
8976A	T156	128
8976B	T156	009
8976C	T156	113
8976D	K14	042
8976E	K14	Keine Tafelabbildung: Geglätteter Stein (L20)
8976F/a-f	T161	009
8976F/g	T165	009
8976F/h	T137	009
8976G	T137	Keine Tafelabbildung: Bohrerkrappe? (kein Kontext)
8976H	K1	Keine Tafelabbildung: Relieffragment (kein Kontext)
8976I	K1	042
8976K	T148	Keine Tafelabbildung: Rundstab (kein Kontext)
8976L	K2	Keine Tafelabbildung: Relieffragment (kein Kontext)

TD-Inv. Nr.	Abb.	Tafel
8976M	T161	087
8976N	T161	087
8976O	T162	002
8976P	T162	002
8976Q	T162	102
8976R	T162	014
8976S	T165	027
8976T	T162	Keine Tafelabbildung: Reibstein (L509)
8976U	T162	112
8976V	T162	112
8976W	T162	147
8976X	T162	138
8976Y	T164	022
8976Z/a-b	T163	100
8977A	T163	Keine Tafelabbildung: Schleifstein (L354)
8977B	T163	091
8977C	T163	032
8977D	T163	050/103
8977E	T163	Keine Tafelabbildung: Polierstein (kein Kontext)
8977F	T164	Keine Tafelabbildung: Klopstein (k/61, U1)
8977G	T164	118
8977H	T164	020
8977I	T164	105
8977J	T163	177
8977K	T165	161
8977L/a	T165	050
8977L/b	T163	050
8977M	T164	139
8977N	T164	Keine Tafelabbildung: Schleifstein (L375)
8977O	T164	149
8977P	T164	018
8977Q	T164	121
8977S	T164	Keine Tafelabbildung: Klopstein (m/58, M198)
8977T	T165	155
8977U	T154	075
9057X	T113	Keine Tafelabbildung: LPW (L263)
9057Y	T113	140
9145B	T120	169
9145C	T125	169
9504Z	T168	020

## BESCHREIBUNG DER WAREN IN DEN KV-ZEICHNUNGEN

Lokus	KV	Ib	Ic1	Ic2	Ie	IIa	IIc	Andere	KV vollständig	KV Auswahl
L016	K8241	1-2	4-5	3; 6-7					x	
L018	K8245	1-2		5-6	4		3			x
L019	K8239	1								x
L020	K8118	1								x
L022	K8116		1-3	4-5					x	
	K8117	1-3	4	6-7		5			x	
L024	K8353	1-4; 8; 13	7; 9-10; 18	5-6; 11-12; 14; 16		20	17; 19			x
	K8366						1			x
	K8375	1								x
L025	K7534	1-5	6-7	8-9	10-11					x
L026	K8133	1-3		4			5	6 (Id)	x	
	K8134	1-6; 10	7; 9	8; 11-13; 15				14 (IV)	x	
L027	K8132	1-3; 7	4	5-6; 8-9			10		x	
L028	K7535	1-2	3-4			5			x	
	K7536	1-7	8	9-10					x	
	K7539	1-2							x	
	K7540	1							x	
L029	K7537	1-2			3				x	
	K7541	1-6	7-8	9-14			15-17		x	
L030	K7386	1	2						x	
	K7735	1-3	4	5					x	
	K7755	1-2	3	4-5			6-7		x	
	K7761	1-2							x	
	K7762	2		1						x
	K7765	1-2		3						x
L031	K7734	1-5; 7-8; 10	6; 9; 11-16	17-23			24			x
	K7736	1-6		7-17						x
	K7737	1-6	7-10	11-14			15			x
	K7739	1-2	3	4-8			9			x
	K7740	1-4		5-8						x
	K7741	1-3	4	5						x
	K7742	1-3		4					x	
	K7743	1-3	4	5-8						x
	K7745	1-4	5	6-8						x
	K7746	1		2-3					x	
	K7747	1-4	5							x
	K7748	1-7	8	9-13						x
	K7749	1-6	7-9	10-21			22			x
	K7750	1-6; 9	7-8							x
	K7751	1-2; 4; 6	3; 5; 8	7; 9-10			11			x
	K7752	1-4	5-7	8	9					x
	K7753	1-4; 7	5-6	8					x	
	K7757	1-7; 15-17; 19-20	11; 18	8-10; 12-14; 21; 24	23		25-27			x

Lokus	KV	Ib	Ic1	Ic2	Ie	IIa	IIc	Andere	KV vollständig	KV Auswahl
	K7758	1-5		6-8						x
	K7759	1-3	4-5							x
	K7760	2	1				3-4			x
L032	K7386A	1-5; 8; 11	6; 9	7; 10; 12-15	16-17		18-19	20-21 (Marl F)	x	
	K7387	1-5	6	10	7	9			x	
	K7387A	1-5; 7		6; 8					x	
	K7738	1-2	3-4	5-6; 8		7			x	
	K7744	1-5	6	7-9					x	
	K7756	1-2		3-7			8		x	
	K7763	1-4	5-6							x
	K7764	1-2		4	3			8889A (Minoisch)	x	
L034	K7376	1-4		5-6					x	
	K7754	1-3	4	5			6			x
L035	K7855	1-9; 15-20	10; 14-15; 21-22	11-13			23		x	
	K7758	1-4; 7-8	5-6	9			10-11		x	
	K7860					1				x
L036	K7396	1-6; 8; 13-14	8	7; 9-12	17		15-16	18 (IV.2) Amphore	x	
	K7416	1-4	5	6-8					x	
	K7417	1-2		3-8					x	
	K7815	1-13	14; 16	15; 17-18			19-20		x	
	K7857	1-8; 10; 12	9	11; 13					x	
L037	K7307	1-6	7-8; 12	10			9; 11			x
	K7313	1; 4	2; 8-10; 14-15	3; 5-7; 11-13					x	
L038	K8390	1-4	5-10	11					x	
	K8404	1-14	15-19	20-22			23			x
	K8406	1-5	6	7			8		x	
L039	K8386	1-24	25-29; 37; 42	30-36; 38-41; 43-47	48	57	49-56			x
	K8396	1-8	9-14	14-20			21			x
L040	K8394		1					8558N/1-6 (minoisch)	x	
L041	K7863	1-3		4					x	
	K7878			1-3					x	
	K7913	1-4							x	
L045	K8128	1-5	6-11	12-14			15		x	
L047	K8388	1-10	11-18; 20	19; 21-23	24		25			x
	K8401	1-7		8-13		14	15			x
L048	K8398	1-10	13	11-12; 14						x
	K8405	1-10	11-13	14-17			18-19		x	
L050	K8407	1-12	13-15	16-17						x
L051	K8408	1-16	17-20	21-22						x
L053	K8409	1	3-7	2; 8-9			10		x	
L076	K7538		1	2					x	
	K8165	1-4		5-7			8-9		x	
L077	K7394	1-12; 16		13-15; 17-22			23-25		x	

Lokus	KV	Ib	Ic1	Ic2	Ie	IIa	IIc	Andere	KV vollständig	KV Auswahl
	K7395	1-20; 42	35	21-34; 36-41	43		44-45			x
	K7522	1-45; 72; 74	46; 48; 55-57; 71	43-45; 49-54; 58-61; 63-67		75- 76	68-70; 73; 77-78	62 (Schlamm und Sand)		x
L078	K7388	1-10; 17-19	11-15; 32	16; 20-31	33-34		35 comp; 36-42	43-45 (IV) Amphoren		x
	K7389	1-10	12; 14	11; 13; 15-18	19		20-22		x	
	K7390	1-17	18-21; 23-24; 28-29	22; 25-27; 30			31-33			x
	K7391	1-15	16-20; 27-28; 30-33	21-26; 29; 34-35	36-37	38- 39	40-46			x
	K7392	1-9; 14-15	10-13; 16-25	26-27						x
	K7393	1-8	10-19; 25	9; 20-24			26 comp; 27			x
	K7526	1-15	16-23; 37	24-28	29		30-36			x
	K7527	1-8; 10-11	9	12-15						x
	K7528	1-4	5	6-8	9		10-11			x
	K7529	1	2-4	5-6	7		8-12		x	
	K7530	1-6	7-9; 13	10-12; 14-17			18-22			x
	K7616	1-8	15	9-14		17	18-21	16 (Id, intrusiv?)		x
L079	K7666	1-9; 20	10-18	19			21-26	27 (IV) Amphore	x	
	K7667	1-6	7-8	9-11			12-14		x	
L080	K7665	1-4		6-9	5				x	
	K7683	1-6		7-9; 11	10				x	
	K8127	1-4	5-10	11-12						x
L085	K8429	1-5					6-9		x	
L090	K7385	1-9; 21	10-12; 14-17	13; 18-20		23	22		x	
	K8145	1-12; 14-16	13	15-19			20		x	
L093	K8148	1-6; 10	8-9	7			11-12		x	
L094	K8149	1-2	3	4-5					x	
L095	K8163	1-7; 9	8; 10-11	12-15	16		17-18		x	
L099	K7371	1; 8		2-7					x	
	K8147	1-7; 10	11	8-9; 12-18			19		x	
	K8430	1-2							x	
L102	K7545	1-5							x	
	K7550	1-8; 10	9	11-16		17?				x
	K7553	1-11	12-14	15-19	20	23- 25	21-22			x
L103	K7543	1-4	5-7	8-9	10		11-12			x
	K7548	1-11; 15; 19	12-14; 20	16; 18-19; 21	22		17			x
	K7551	1-12	13-23	24-25	30-31	26	27-9			x
L105	K7544	1-6	7-10		11			8618U, 8618V (LPW)		x
	K7547	1-13	14-22; 29	23-26	27		28			x
	K7554	1	2-4	5-6						x
	K7555	1-5	6-8	9-11			12-13			x
L106	K7546	1-7; 9; 12	10-11	8	12		14		x	
	K7812	1-7	8-9						x	
L107	K7552	1-2	3	4			5		x	
	K7558			1-2					x	

Lokus	KV	Ib	Ic1	Ic2	Ie	IIa	IIc	Andere	KV vollständig	KV Auswahl
L110	K7519	1-4	5-10	11-14			15-16			x
L111	K7521	1-14	15-18; 22-25	19-21; 26			27-29			x
L112	K7520	1-6	7-10	11-13						x
L115	K7523	1-3	4						x	
L130	K7370	1		2;4				3 (IV.2, Amphore)		x
	K7373	1-3; 5		4; 6			7	8-9 (IV, Amphoren)		
L132	K7374	1-2		3				IV.2 (Amphore)		x
L136	K7675	1-8	9-14	15-20					x	
	K7679	1-7	8-10	11-13			14-17		x	
L143	K7708	1-8; 11; 19	9-10; 12	13-17			18		x	
L155	K7626	1-2	3				4		x	
L156	K7401	1-3	4	5					x	
	K7426	1-2							x	
	K7617	1	2-4	5			6-7			x
L161	K7630		1							x
L163/ L164	K7491	1-3	5-6	4			7			x
	K7500	1-4; 8-9	7	5-6			10-12			x
L164	K7512	1-2	3-4; 7-8	5-6; 9			10			x
L165	K7490	1-10; 18		11-17; 20		22-23	19; 21			x
	K7515	1								x
L171	K7493	1-3		4						x
	K7503	1-5		6			7			x
	K7504			1						x
L172	K7501	1-5	6; 8-9	7		10	11-13			x
L173	K7477						1			x
	K7510	1-7; 9-10; 14-16	11-13; 21-23	8; 17-20	25		26-28			x
L176	K7474	1-6; 23	7-10; 20	11-19; 21-22; 24-27; 33-34			28-32			x
	K7488	1-12	15-17	13-14; 18-19			20			x
	K7489	1-6; 11; 15	12-14; 16	7-10; 17			18			x
	K7497	1-16	17-31	32-37		38	39-43			x
	K7498	1-8	9-14	15-26		27				x
	K7499	1-7	9-15	8; 16						x
L182	K8137	1-2		3-4	5		6-7	8619A (LPW)		x
L187	K7398	1-4							x	
L200	K8153	1-9; 16-17	10; 13	11-12; 14-15			18-19		x	
L201	K8150	1-3	4-5; 7	6		8			x	
L211	K7571	1-4	5	6-10					x	
L212/ L213	K7559	1-3	4-8	9					x	
L216	K7423	1-2; 4-5	6	3						x
L217	K7688	1-7; 13	8-12	14-21; 28	22	23	24-27			x
	K7692	1-12; 16-18	13-15; 19-21; 23; 28	22; 24-27; 29			30-32		x	



Lokus	KV	Ib	Ic1	Ic2	Ie	Ila	Ilc	Andere	KV vollständig	KV Auswahl
L221	K7481	1-2	4	3; 5						x
	K7494	1-2		3						x
L226	K7813	1-4; 9	5-6	8; 15	7	11, 12	13	10 (Id); 14 Amphore (IV); 8886Y (LPW)	x	
L228	K7323	1-3	4	5-8		11-13	9-10	8617E (LPW)	x	
L231	K7766	1-4; 19-20	13-15; 17	5-12; 16; 18			21-24			x
	K7777		1							x
L234	K7324	1-7; 9-16	8; 17-26	27-30	34?	32	33	8617C2 (LPW)		x
	K7325	1-12; 15-22; 28-29	13; 23-27; 30-42; 45	43-44; 46-48		49	50-56			x
L235	K7336	1-8	9-13	14-16			17-18			x
	K7377	1-4		5-6						x
L239	K8411	1-4		5-6						x
L241	K8421	1-3		4	6	7	5			x
L242	K7821	1-2						IV.2(?)	x	
L245	K8151			1						x
L249	K7567	1-4	6-7	5					x	
L250	K7568	1-5	6						x	
L252	K7577	1-4; 6	6; 8; 10	7; 9; 11-14		15				x
L253	K7565	1-5; 9	6	7-8			10-11			x
L254	K7563	1-20	21-28	29-43	44-45	46	47-50			x
	K7566	1-3	4						x	
L255	K7572	1-2								x
L256	K7570			1-2						x
L259	K7469		1	2-3					x	
	K8124	1-5	6-10	11-13		14			x	
L266	K7411			1		2				x
L269	K7410/7426			1						x
L270	K7415			1						x
L271	K7431	1	2; 4	3; 5						x
	K7436	1-4		5						x
	K7444	1-3	4-7	8	9					x
L272	K7443				1					x
L273	K7429		1							x
L281	K7458	1-2	3-4	5-6			7-8			x
L285	K7651	1-4; 7	5	6					x	
L291	K7710	1-11; 13-14	12; 15-17; 22	18-21; 23-26		27	28		x	
L292	K7713	1-4; 7	10-12	5-6; 8-9; 13-14		15				x
L294	K7706	1-3	4	5; 7-8			6		x	
L296	K7824	1-4; 7	5				6			x
L298	K7422	1-3	4-5				6			x
	K7435	1-2					3			x
	K7438	1-5	6-9	10						x
L301	K7430	1		2-3	4					x
	K7437	1-4	5	6						x

Lokus	KV	Ib	Ic1	Ic2	Ie	IIa	IIc	Andere	KV vollständig	KV Auswahl
	K7446	1-2; 4	3; 5-8	9-12			13			x
L302	K7433	1-4		5-6			7-8			x
	K7445	1-2	3-7	8	9		10			x
	K7450	1	2-3; 5-8	4	9					x
L313	K8185	1-2					3	8617A (LPW)	x	
L314	K8176				1					x
L320	K7353			1	5-7		2-4			x
L321	K7326	1	2-3	5			4		x	
L323	K7334	1-4	5-6	7-11						x
L333	K7309	1-2		3						x
	K7315	1-4		5						x
	K7317	1-5		6-9						x
L337	K7335	1-6; 12	7	8-10	11	13	14-15			x
L338	K7327				1	2				x
L340	K7781	1		2-3					x	
L341	K7788	1								x
L343	K7319	1	2; 4	3; 5			6		x	
L346	K7725	1-7; 9	8	10-12					x	
L347	K7711	1-4	5-6	7-9					x	
L349	K7722	1-15		16						
L352	K7660	1-5; 8; 11; 14	6-7	9-10; 12-13; 15-17		19	18	8889C (LPW)	x	
L355	K7614	1-14; 23	15-19; 21	20; 22					x	
L356	K7589	1-3	4-5	6-7			8-10		x	
	K7608	1-5		6-8			9		x	
L357	K7585	1		2-3						x
L360	K7578	1-22	23-34	35-48			49-51		x	
L361	K7580	1-6	7-12	13-22		24- 25	23			x
L363	K7582	1-2		3-4						x
	K7590	1-2	4; 6	3; 5						x
L364	K7579	1-12	13-22	23-26		27	28			x
L366	K7588	1-2				4	3			x
L367	K7581	1-2; 4-6; 13; 15	3; 7; 12; 14; 16-18; 22	8-11; 19-21; 23-27	28					x
L368	K7591	1-5	6-7; 11-12	8-10; 13-15			16-17			x
L371	K8413	1-7		8-10			11-14		x	
L373	K8414	1-2		3	4-5				x	
L376	K7792	1-5								x
L380	K7345	1-7	8-10	11-13		14	15-16			x
L383	K7343	1-3	4							x
L396	K7715	1-4; 5	5-6	8-12			13-15		x	
L398	K7714	1-3	4	5-7			8		x	
L400	K7440	1		2	3		4-5		x	
L413	K7354	1-5								x
L418	K7594	1-8	9-14	15-27; 35-36; 39-42	28-20; 33	38	32; 34; 37		x	

Lokus	KV	Ib	Ic1	Ic2	Ie	IIa	IIc	Andere	KV vollständig	KV Auswahl
L419	K7595	1-15	16-23	24-31	32-35					x
L420	K7600	1-37	38; 42; 45-48; 51	39-41; 43-44; 49-50	52	53	54-56		x	
L421	K7601	1-6; 9; 18	7; 13; 19	8; 10-12; 14-17; 20; 22		21			x	
	K7603	1-35; 37; 39-40	36; 38	41-53			54-55		x	
	K7610	1-2							x	
L422	K7596	1-9	10	11		12- 13				x
L423	K7592	1-5	6-10	11-19		20				x
L424	K7593	1-8; 10-11	9; 12-16	17-24						x
L431	K7455	1-2; 5-8	3-4; 9-13	14		15				x
L444	K7351	1		2-4; 6			5		x	
L446	K8416	1-5		6		7			x	
	K8419	1-3	4						x	
L449	K7806	1-4	6-8	5; 9-12; 14			13		x	
L452	K7612	1-5; 710	16; 19-20	6; 11-15; 17-18; 21-23					x	
L454	K7604	1-14; 16; 18-23; 25-26	15; 17; 32	24; 27-31					x	
L455	K7605	1-11; 28; 36; 42	12-22; 35; 40; 43	23-27; 29-30; 32-34; 37-38; 39; 41	31				x	
L457	K7368	1-3; 6	4-5				7-8		x	
L469	K7364	1-5					6		x	
L479	K7524	1-10; 12	11; 13; 20; 23	14-19; 21-22		27	24-26			x
	K7816	1-11	12-13	14						x
L481	K7531	1-6; 8-9	7	10-11; 13				12 (IV)	x	
	K7533	1-4		5-6					x	
L482	K7828	1-7		8-17	18		19-34; 24 (comp.)		x	
	K7829	1-11; 14	12-13; 15	17-35			36-40			x
	K7990	1-4	5-6	7-10						x
	K8101	1-6			7					x
L483	K7836	1-8; 15-16	17	9-14		18	20-25		x	
	K7845	1-9; 12	10-11; 13-15	16-17					x	
L484	K8104	1-3; 6	4	7			5			x
L485- L490	K7846	1-6	7							x
L487	K8110	1-5; 7	6	8		10- 11	9		x	
	K8114	1-7; 9	11-12	8; 10; 13			14-15		x	
L488	K7843	1-3; 9	6-8	4-5					x	
L489	K7841	1-3		4-5					x	
	K7844	1-7	8	9-14					x	
L491	K8106	1-7; 15	13; 17	8-12; 14	16		18	19 (IV.2, Amphore)		x
L492	K8107	1-7	9	8; 10-14						x
L494	K8109	1-7	8	9-11		12			x	

Lokus	KV	Ib	Ic1	Ic2	Ie	IIa	IIc	Andere	KV vollständig	KV Auswahl
L504	K7865			1						x
L511	K7852	1-5; 9	11	6-8; 10; 12			13-14		x	
	K7853	1-4	5-7	8-9					x	
L512	K7840	1-6	7-9	10-16			17		x	
L513	K7835	1-4	6	5			7		x	
L514	K7837	1-13; 16		14-15; 18-19			17			x
L516	K7826	1-8		9-13			14-18		x	
	K7830	1-2		3	4		5-6		x	
L517	K7833	1-3					4			x
	K7834	1-12	13	14-17		18	19-20		x	
L519	K8344	1-3; 5; 18; 25; 27; 29	6-12; 26; 28	13-17; 19-24; 30			31-32			x
L520	K7920	1-7; 15; 19	8-12; 14; 16; 18	13; 17		20				x
	K7921	1-32; 51-53; 62-63; 67	33-37; 54-56; 60; 64; 66	38-50; 57-59; 65	61		68-71		x	
	K8338	1-19; 43	20-22; 24-28; 37-39; 44	23; 29-36; 40- 42; 45			46-48		x	
	K8339	1-9; 14-17; 19-20	10; 18; 21-22	11-13; 23; 25	24		26-27			x
	K8340	1-7	8	9-13			12			x
	K8341	1-10	11-14	15-19			20			x
	K8342	1-11	12-15; 23-26	16-22; 27			28-32			x
	K8343	1-4	5						x	
L521	K7936	1-2	3-4	5					x	
L522	K8336	1-6	7	8-9			10-12		x	
	K8337	1-56	7-8						x	
	K8345	1-8; 20	16-19; 23	9-15; 21-22; 24-26			27		x	
L523	K7935	1-3	5-6	4						x
	K8347	1-8; 20-21	9-19; 33-34	22-29; 31-32	30		35-36			x
L524	K7933	1-8; 10; 16-17	9; 13-14	11-12; 15			18		x	
L526	K7972	1-4; 6	5	7-10					x	
L528	K7939	1-3; 5		4; 6-7					x	
L529	K7905	1-5; 10	6-9; 11	12-15	16-18		19		x	
L530	K7906	1-6	7-10	11				8618T (WPPL)	x	
L531	K8382	1-3	4-5	6-9						x
	K8389	1-20	21-24	25						x
	K8403	1-7	8-13	14-15			16-17			x
L532	K8378	1-2; 4		3					x	
	K8391	1-8; 11-12	9-10; 13-16	17-20			21-22			x
	K8399	1-8; 11	9-10; 12-13	14-17						x
L533	K8387	1-11; 14	12-13; 16	15; 17-22						x
L534	K8379	1-10	11-13	14; 16-18			15			x
L535	K8332	1-6					7			x
	K8334	1-5; 7-12		13			14-18	Id (6); LPW (8559Q)		X
L536	K8364	1-14	15-28	29-32			33			x
	K8371	1-12; 14-15; 21	13; 16-20; 22-31	32-39	40	42	41		x	

Lokus	KV	Ib	Ic1	Ic2	Ie	Ila	Ilc	Andere	KV vollständig	KV Auswahl
	K8372	1-4; 7; 9	5-6; 8; 10-11	12					x	
L539	K8265	1-2	3-4	5					x	
L540	K7925	1-2; 4	6	3; 5					x	
L544	K8333	1-3		4-5					x	
L547	K8315		2	1						x
L551	K7969a			1						
L557	K7945			1						x
L564	K7962			1						x
L579	K8377	1-5; 7	6; 11	8-10			12-14		x	
	K8392	1-17; 20	18; 20-24	25-29			30		x	
L580	K8395	1-7	8-15	16-17			18	8559S (minoisch)	x	
L583	K8400	1-5	6; 8-9; 11; 13	7; 10; 12	14					x
L584	K8402	1-2	3-4	5-6						x
L585	K8355	1-2		3			4		x	
	K8358	1-7	8-11				12		x	
	K8359	1-10; 14; 21	11-13; 15-20; 22; 24	23; 25-27					x	
	K8361	1-4	5-7						x	
	K8383	1-14; 21	15-20; 22-25	26			27-28			x
	K8384	1-12	13-16				17			x
L586	K8357	1-4								
	K8362	1-6; 8	7; 9-10; 13; 15-16	11-12; 14						
	K8368	1-4; 6	5; 7-9							
L587	K8356	1-5					6		x	
	K8363	1-23	24; 28	25-27; 29-34		36	35			x
	K8367	1-14	17-18	15-16; 19-21						x
	K8373	1-3; 6	4	5; 7-8					x	
L590	K8354	1-2; 8	3-4; 6	5; 7; 9-15			16		x	
	K8360	1-16; 20-25	17-19; 26-29	30-40	41		42		x	
	K8369	1-17; 22-29; 47	18-21; 30-40; 48	41-46; 49-50		51			x	
	K8374	1-3		4-6					x	
	K8385	1-13	14-15	16-23						x
L591	K8365	1-11; 14	12-13; 15-18				19		x	
	K8370	1-7; 10	8-9	11-14; 16			15			x
	K8376	1-14	15	16-20			21			x
L596	K8111	1-22	23; 27-28	24-26; 29-34			35-42		x	
L597	K8112	1-9	10-11	12-18	19	23	20-22		x	
L598	K7999	1-4	8-9; 11-16	5-7; 10; 17-18			19		x	
L599/ L493	K8108	1-23	24-26; 30	27-29; 31-36; 41			37-40			x
L601	K7991	1-8	9-10			11	12-13		x	
	K7992	1-11	12-15	16-25	28		26-27			x
	K7993	1; 3	2	4-6					x	
	K7998		1	2-7						x
L602	K8102	1-9	10	11-15; 17-18			16		x	
L603	K7988	1-9	10-11; 13	12; 14-17			18-19		x	

Lokus	KV	Ib	Ic1	Ic2	Ie	IIa	IIc	Andere	KV vollständig	KV Auswahl
	K7996	1-2		3-4					x	
	K7997						1-10			x
	K8100	1-10; 12; 22	11	13-21; 24			23; 25-27			x
L614	K8319	1-8; 10-11	9; 12	13-14		15			x	
L622	K8298	1								x
L647	K8138	1-19; 22	20-21; 23-24	25-27			28			x
	K8139	1-3	4-5							x
L649	K7569	1-6	9-12	7-8						x
L650	K7575	1	2	3					x	
L653	K8346	1-11	20	12-19; 21-22	23	24	25-27			
L654	K7987	1-5; 8; 10		6-7; 9; 11	12 (Ic2)		13			x
j/61, Gru. 2	K8423/ 24	1-3; 10	7	4-6; 8-9	12-13; 22-23		11; 15-19	20 (IV, Amphoren); 21 (TY)		x
	K8422	1-4		5-7	8		9-10		x	
k/59, Gru. 12	K7329	1-4	5-9	10			11-12			x
k/59, Gru. 18	K7328	1-6	7-9; 12-14	10-11; 15; 17			16			x
k/58, zw. M669 und M670	K7759	1-3	4-5							x
k/59, M674	K8431	1		2						x
k/59, Gru. 18	K7328	1-6	7-9; 12-14	10-11; 15; 17			16			x
k/59-O, Gru. 7	K7331	1-2		3-5			6			x
k/59-O, Gru. 22	K7369	1-8		9			10			x
k/61, Gru. 1	K8208	1-7		8						x
	K8209	1-3				4				x
k/61, Gru. 3	K8200	1-14	20	15-19						x
	K8201	1-2		3-6						x
	K8214	1-13	14; 18-19	15-17; 20-32; 35-36			33-34			x
k/61, Gru. 4	K8205	1-29; 34	30-33; 35-49	50-58						x
	K8210	1-3	4	5-11	12		13-15			x
k/61, Gru. 11	K8226	1-2		3-5						
I/61, M166	K8285	1								x
I/61, U1	K8288	1-6; 9	7	8					x	
I/61, Gru. 1	K8248	1	2; 5	3-4; 8-9			6-7			x



Lokus	KV	Ib	Ic1	Ic2	Ie	IIa	IIc	Andere	KV vollständig	KV Auswahl
m/62, Gru. 4	K8330	1-5		6-9	10-11		12-14			x
m/62, Gru. 17	K8348	1-11		12-21			22-24		x	
m/62, O-Profil	K8381	2		1; 3						x
n/59, M418/ 420/421	K7403	1								x
n/59, Gru. 18	K7449	1-8	9-13	14-16					x	
n/60, M533	K7428	1-7		8-14			15			x
n/60, M410/ 41	K7483						1			x
n/60, Gru. 5	K7525	1-20	21-27	28-32	33-34		35 (comp.) -43			x
n/60, Gru. 10	K7476	1-4	5-6	7-10						x
	K7478	1; 5-6; 9	2-4; 8	7			10			x
n/60, Gru. 11	K7466		1							x
n/60, Gru. 14	K7463	1-6	7; 14	8-10	11		12-13			x
n/61, M589- 94	K7861	1-12; 19		13-16; 18	17		20-22		x	
n/61, Gru. 1	K7832	1-10	16-17	11-15	20-22		18-19; 23-25	26-27 (IV, Amphoren)	x	
n/61, Gru. 2	K7827	1-2		3-4				5 (IV, Amphore)	x	
n/61, Gru. 3	K7831	1-4; 7	5-6; 8	9-11	12-14				x	
n/62, Mauern str. c und b	K8103	1-2		3-4					x	
	K8105	1-4				6	5		x	
	K8113	1-3							x	
o/59, M519- 20	K7598	1-9	10-11; 16	12-15; 17-18					x	
o/59, M513/ 514/ 521/ 560	K7609	1-5		6-15						x
o/59, M554- 561	K7564	1-5	6-7	8-9		10	11		x	
o/59, zw. M561- M547	K7561	1-4	5-7	8		9			x	



Lokus	KV	Ib	Ic1	Ic2	Ie	Ila	Ilc	Andere	KV vollständig	KV Auswahl
o/59, M567	K7557	1-4	5-9	11			10			x
	K7587	1	2				3			x
o/59, Mauern str. c	K7586	1-3	4-5	6					x	
o/59, Mauern str. e/1	K7597	1-19	23-24; 31-33	20-22; 25-30; 34-36	37		38-39		x	
o/59, Mauern str. e/2	K7609	1-5		6-15					x	
o/59, Gru. 1	K7556	1-2; 5-6	7	4; 8-10					x	
o/59, Gru. 2	K7549	1-9	10-13	14-16						x
o/59, Gru. 5	K7560	1-10	11; 13	12; 14-17			18-19			x
o/59, Gru. 8	K7562	1-8	12-14	9-11; 15-20		21- 22	23-25			x
o/59, Gru. 9	K7573	1-2		3-4					x	
o/59, Gru. 10	K7574	1-3	4	5-6					x	
o/59, Gru. 12	K7576	1-2				4	3		x	
o/59, Gru. 18	K7583		1						x	
o/59, Gru. 22	K7602	1-10; 15	16-17	11-14; 18-22					x	
o/59, Gru. 25	K7613	1-3	5	4; 6; 8	7					x



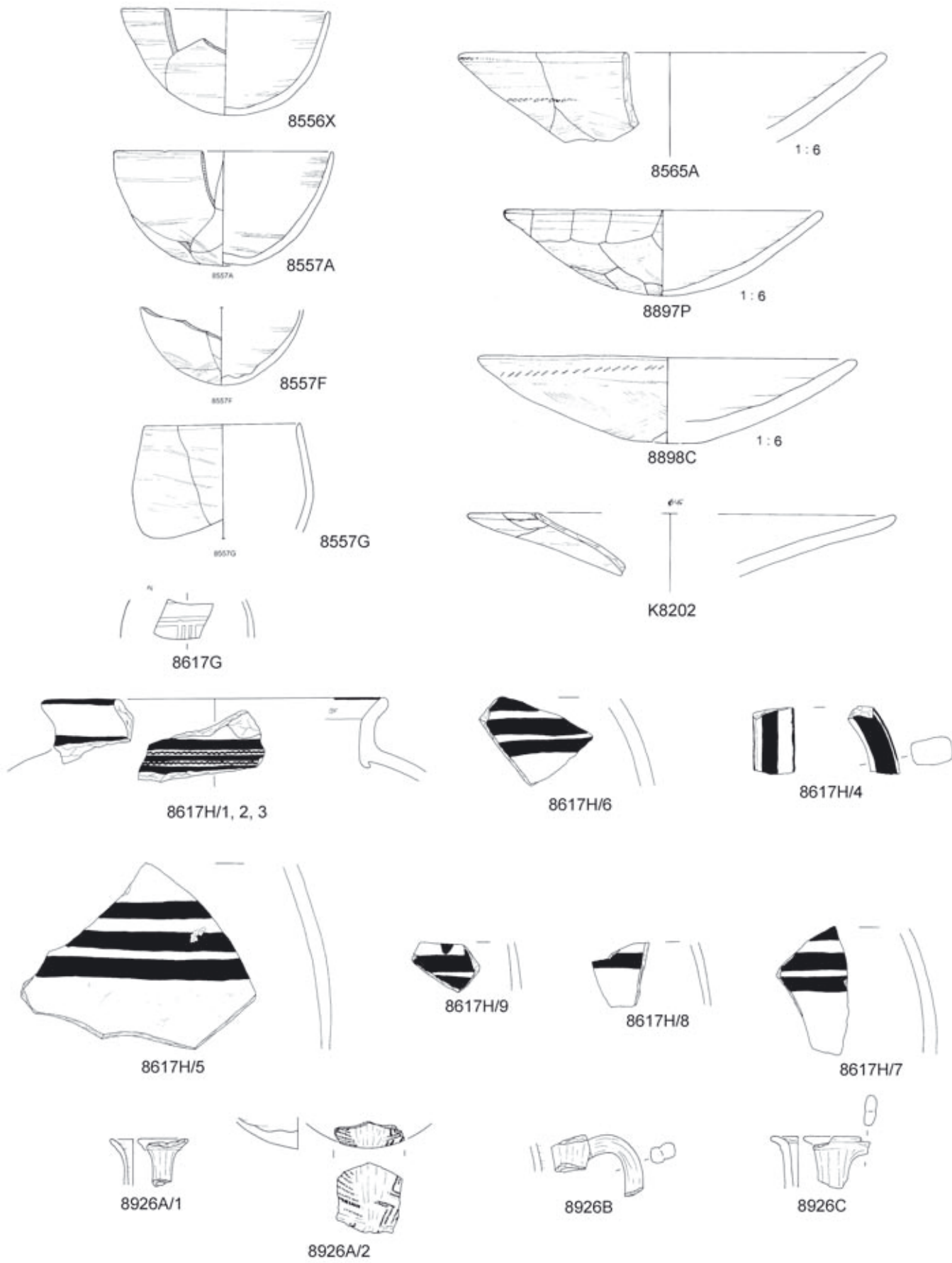

L2

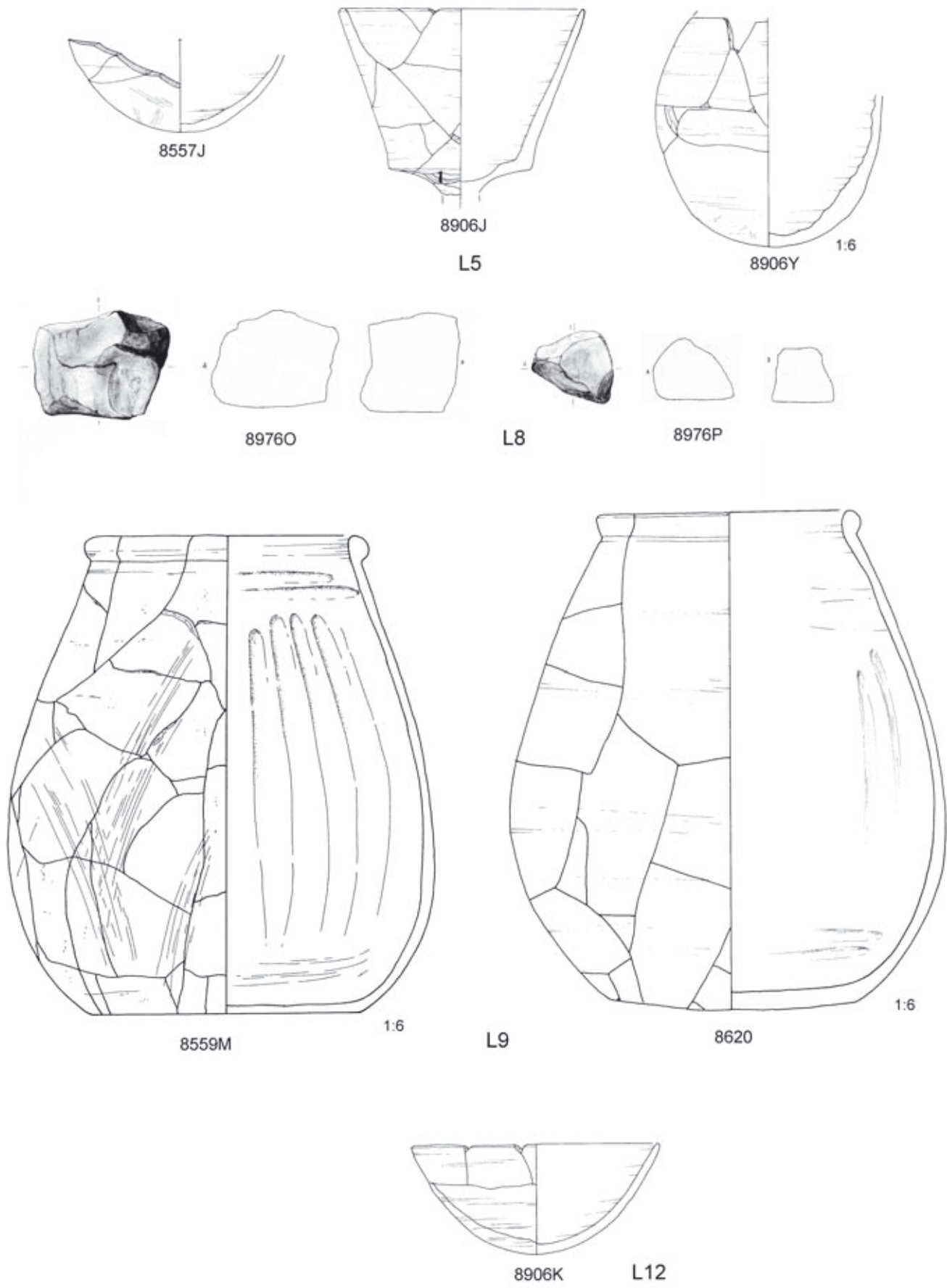

K8241

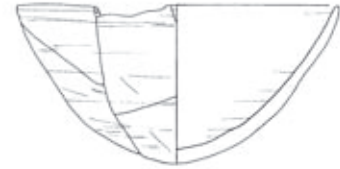
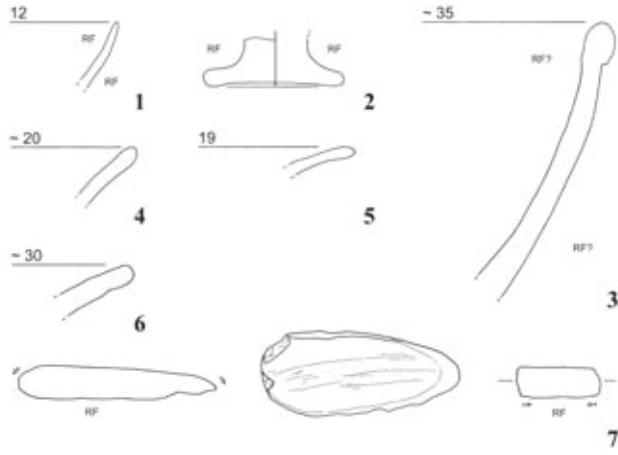

8887L



8569I

1:6

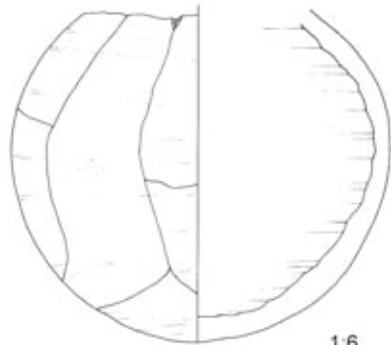

8620D

1:6

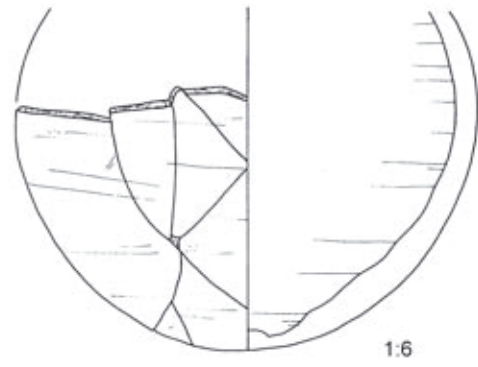

8886S

1:6

L16



8594

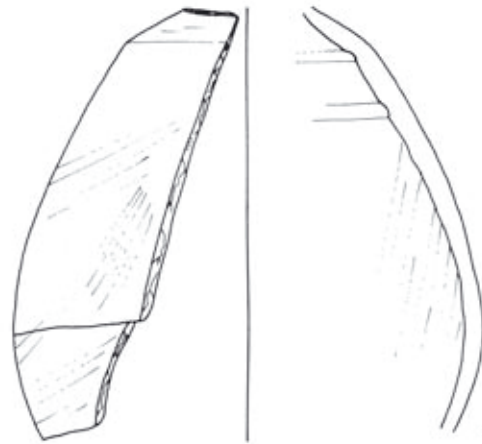

8886K

1:6



8887P



8897Q

1:6

L17

K8245

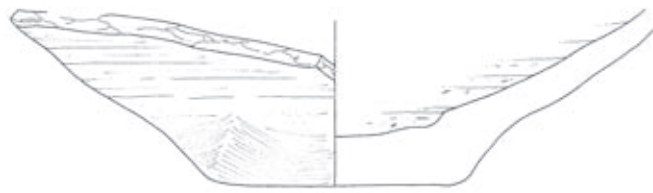
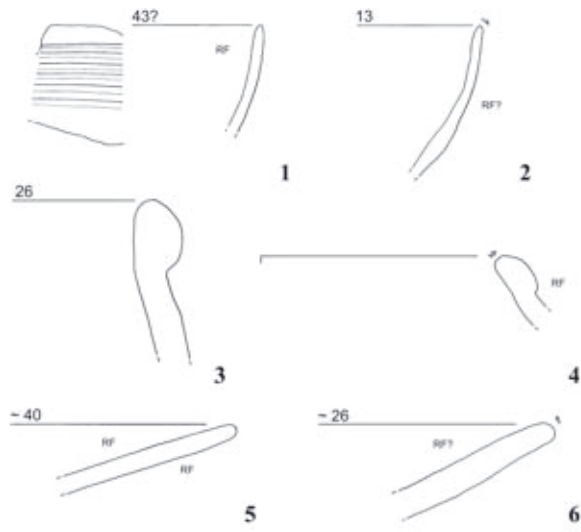

8887Q

L18



8888J

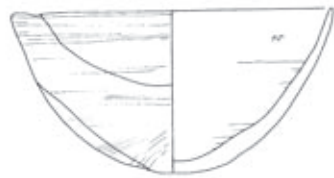

8887N

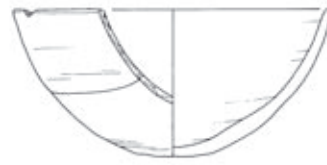

8904S

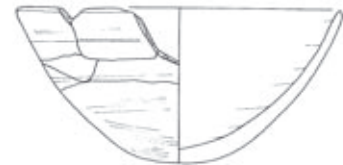

8904T



8906Q



K8239

L19

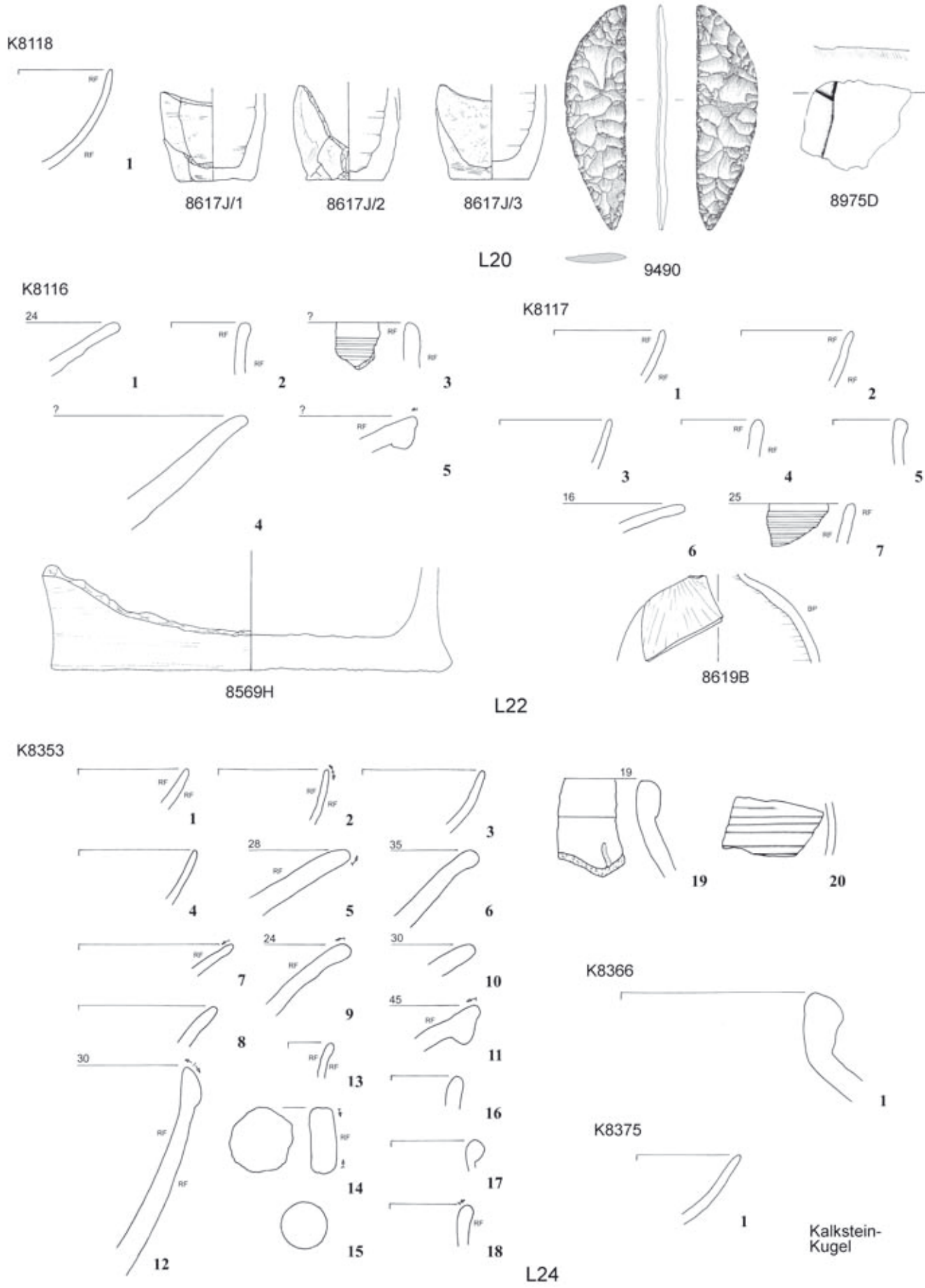

Tafel 5



K7534

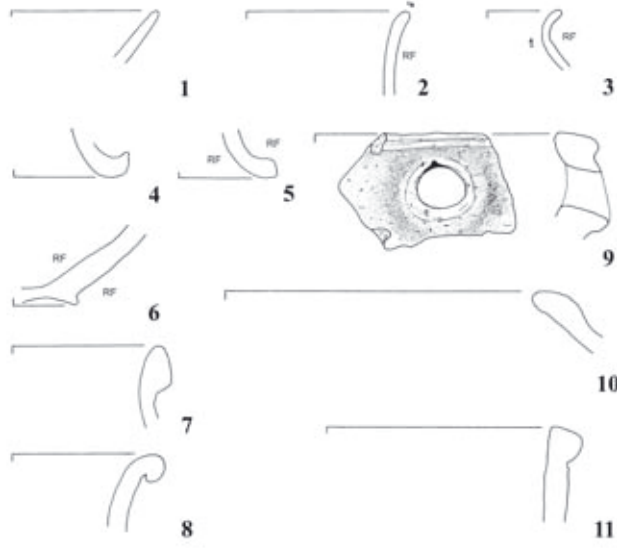

K8131 (Füllschutt)

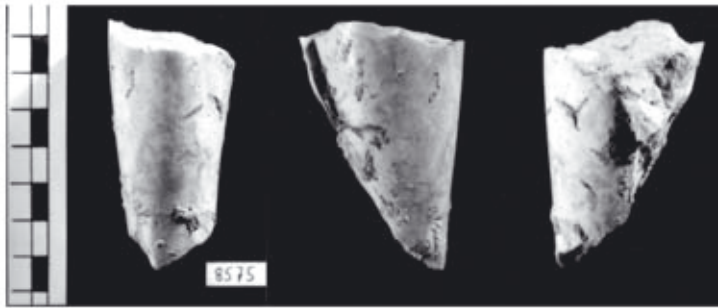
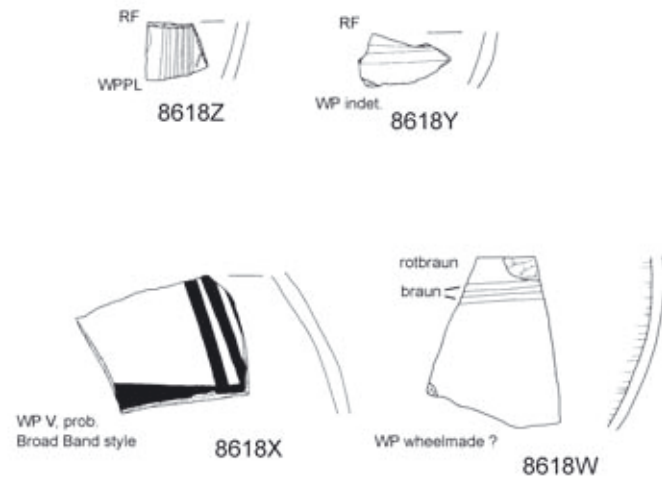

1:2

8575

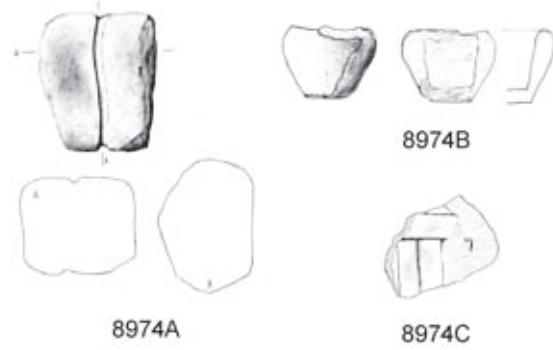

8974A

8974C

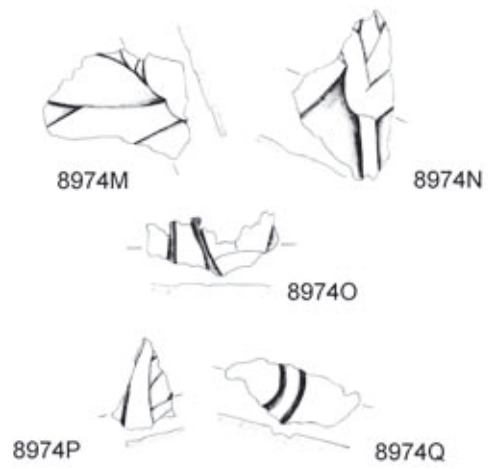

8974M

8974N

8974O

8974P

8974Q



8975F



8975G

L25



K8133

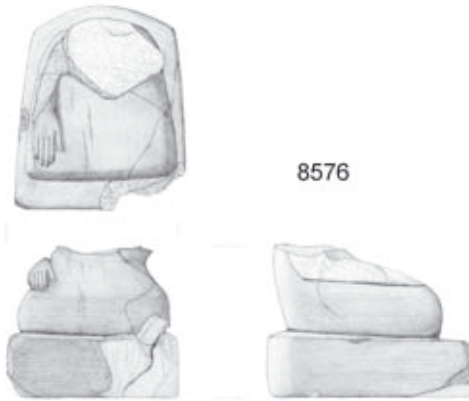
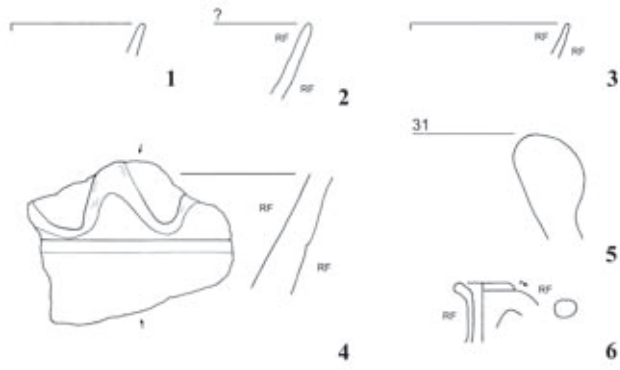

K8134

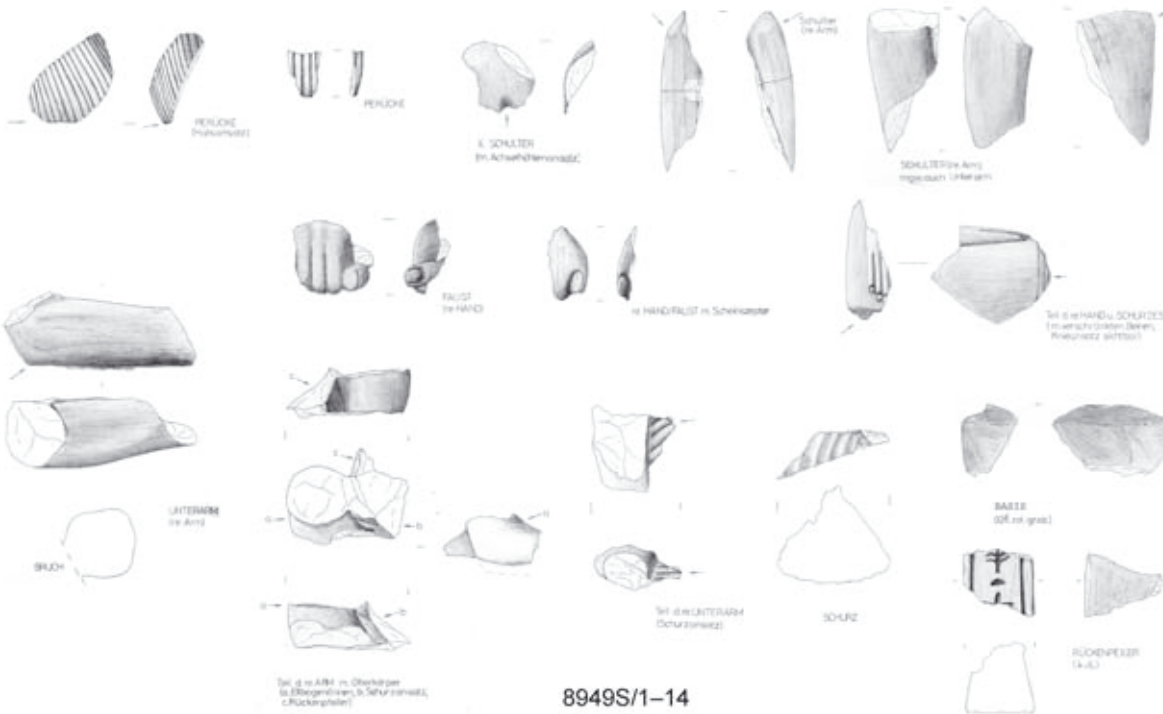
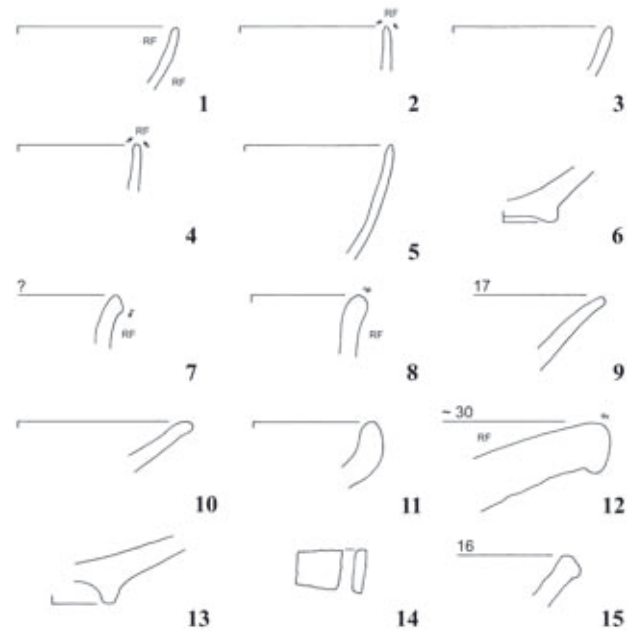

L26

8949S/1-14

K8132

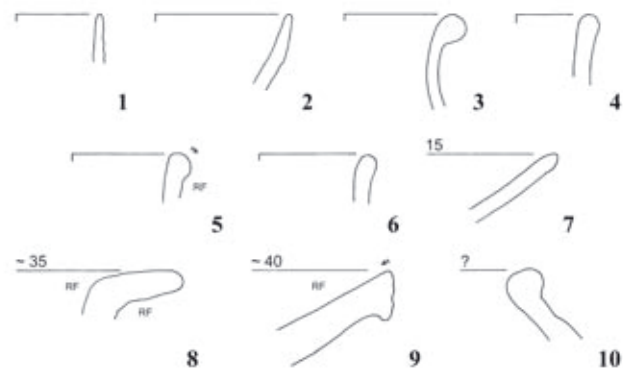

K8135

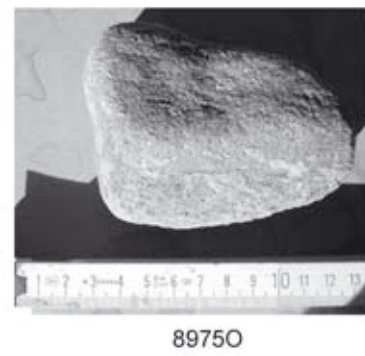
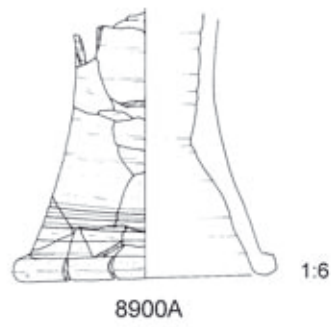
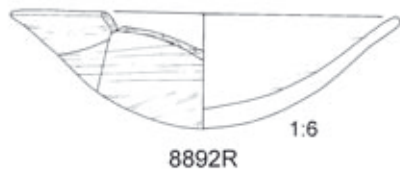
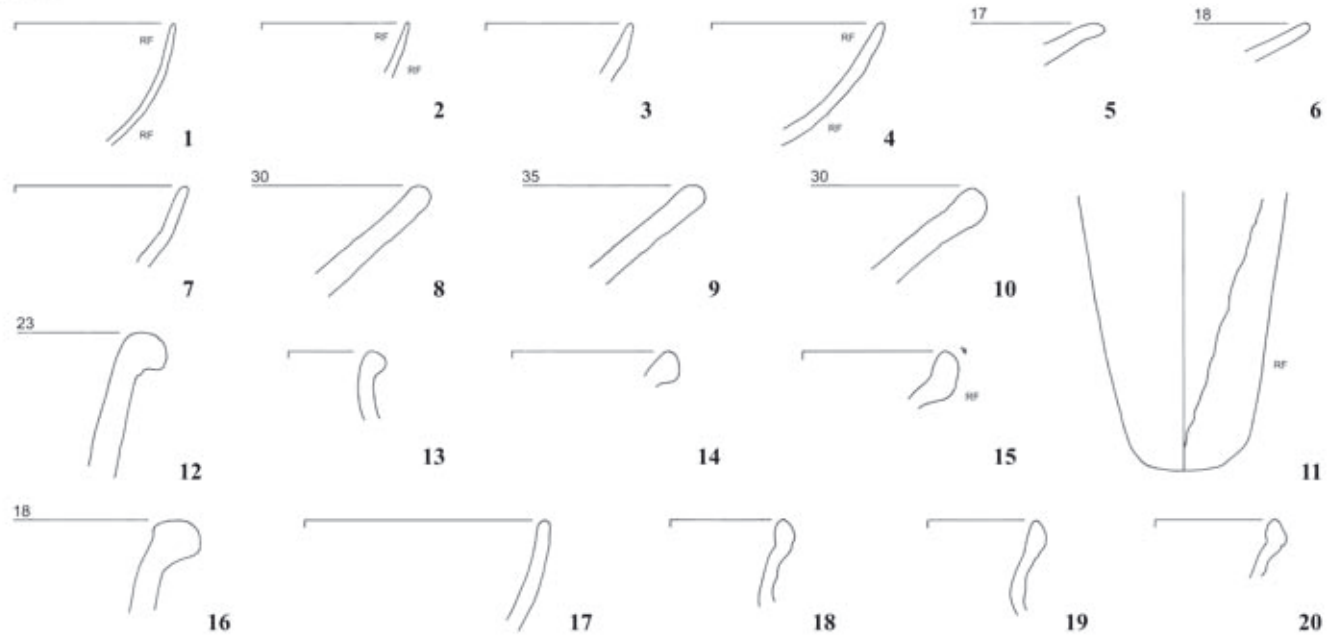

L27

Tafel 8

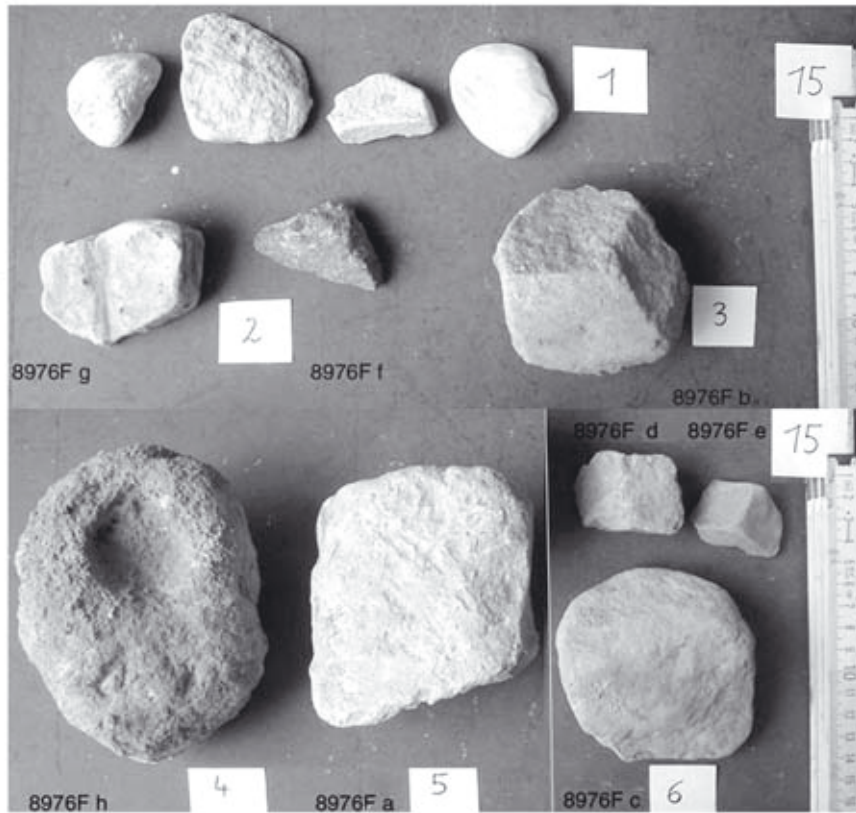
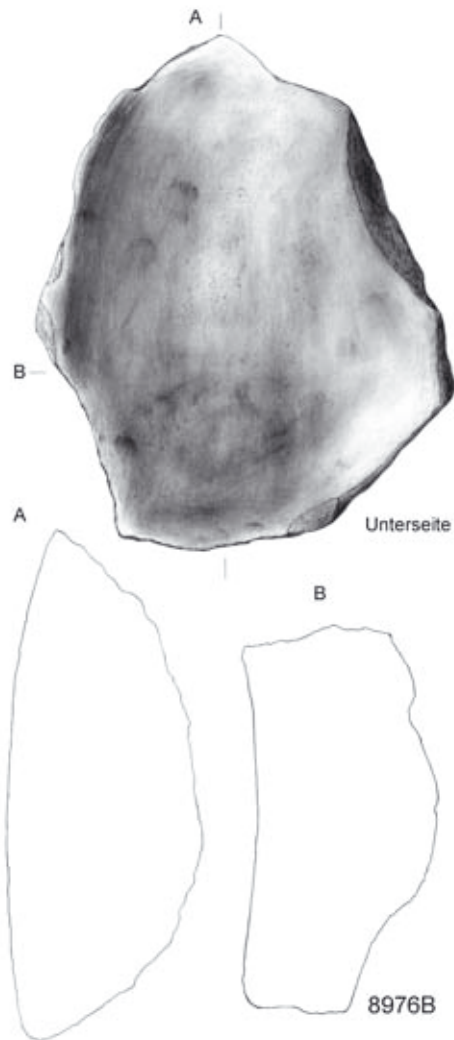
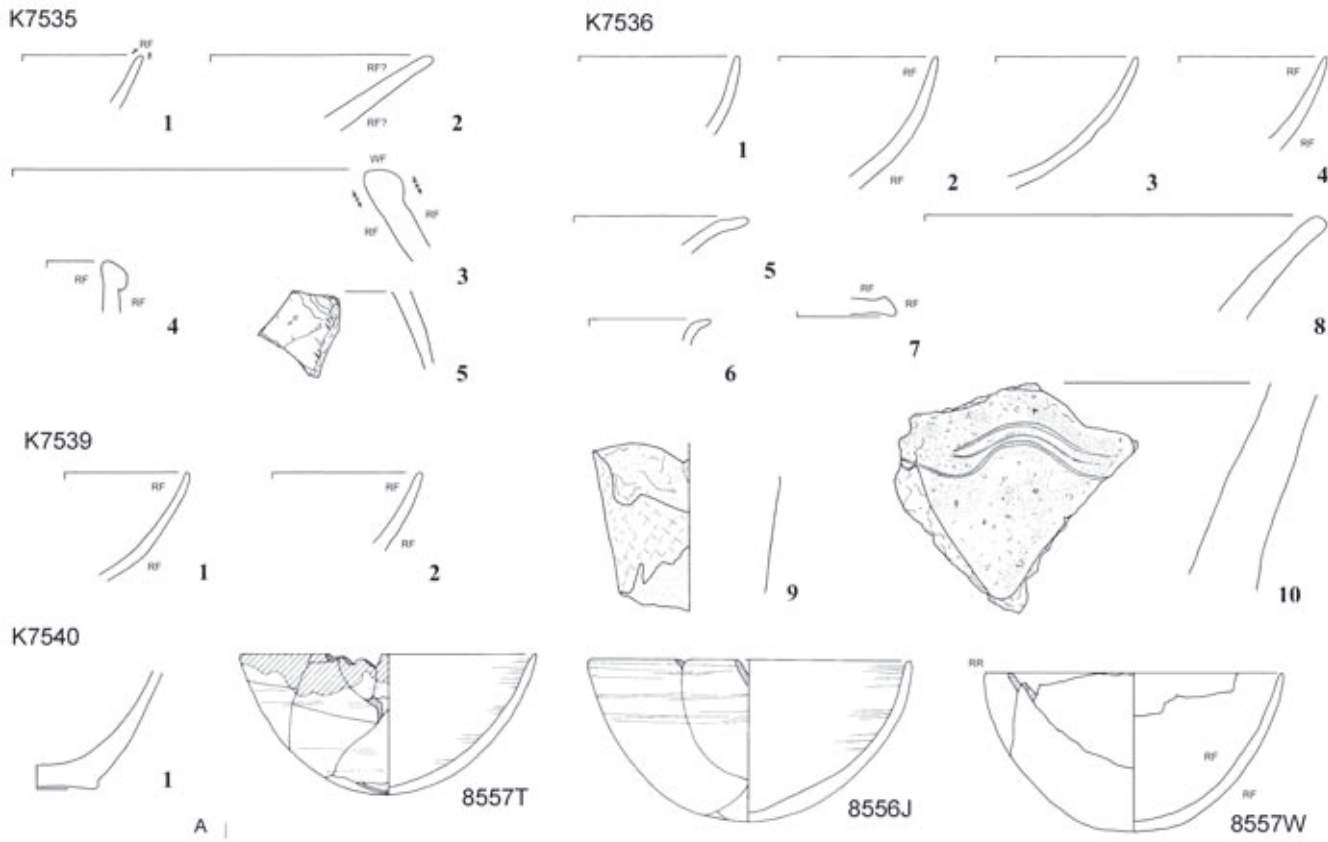

L28  
Tafel 9

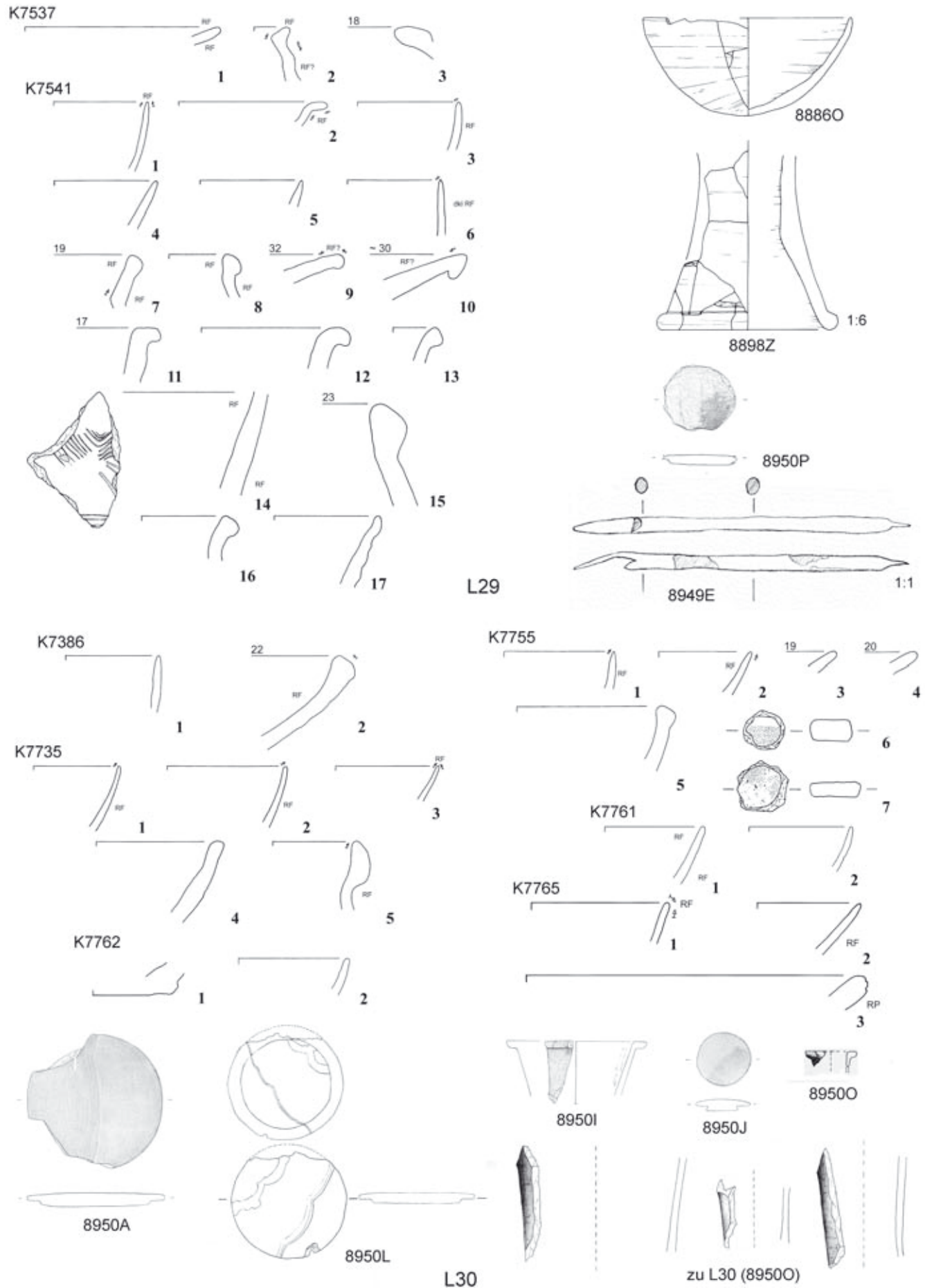

K7734

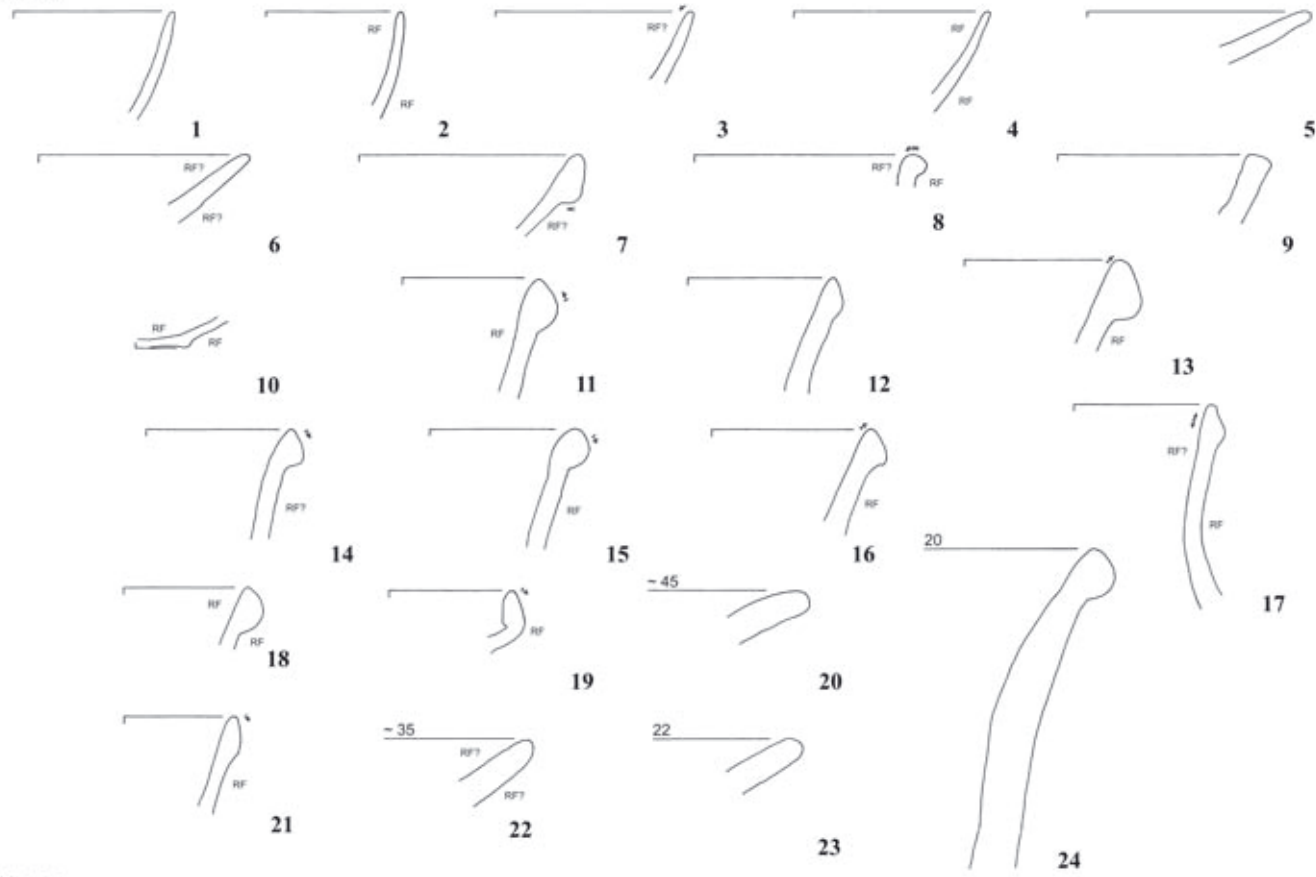

K7736

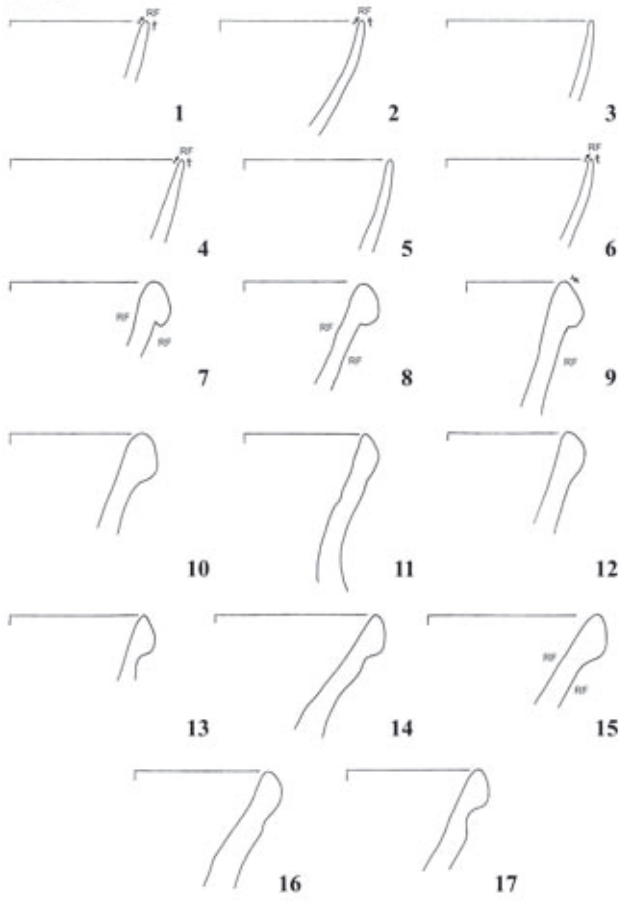

K7737

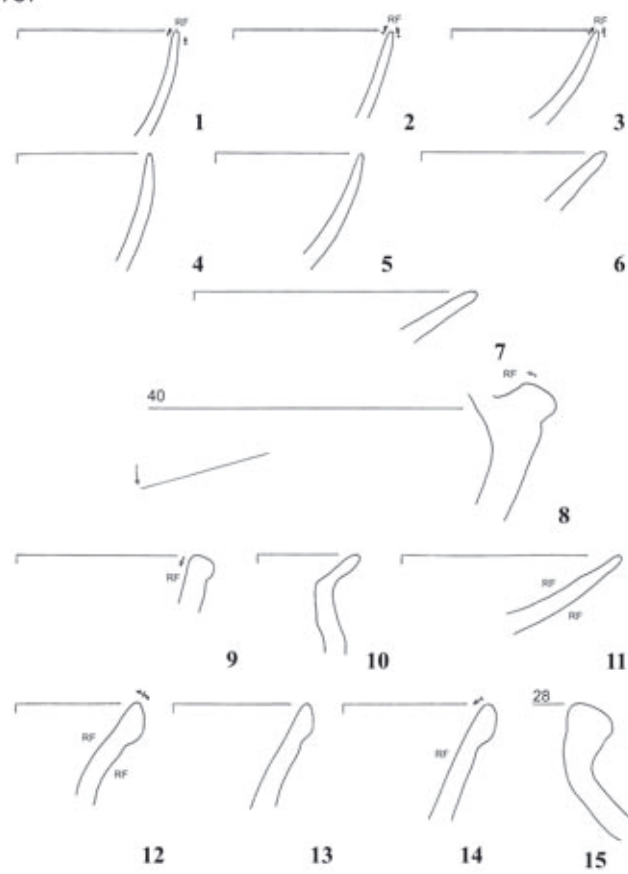

L31 (1)



K7739

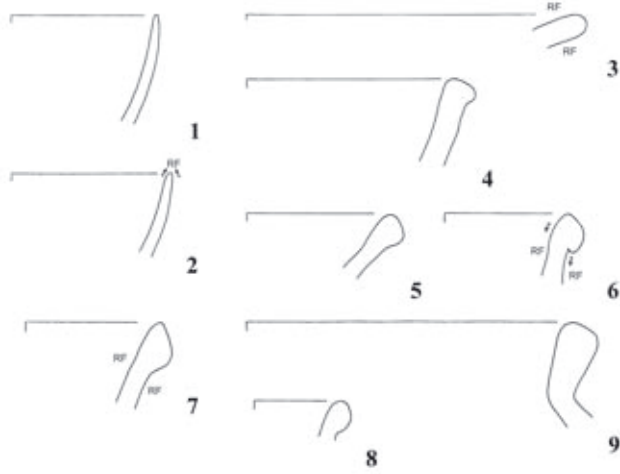

K7741

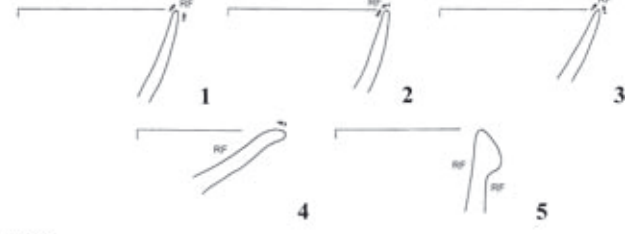

K7742

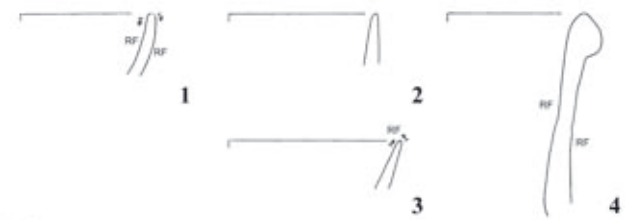

K7740

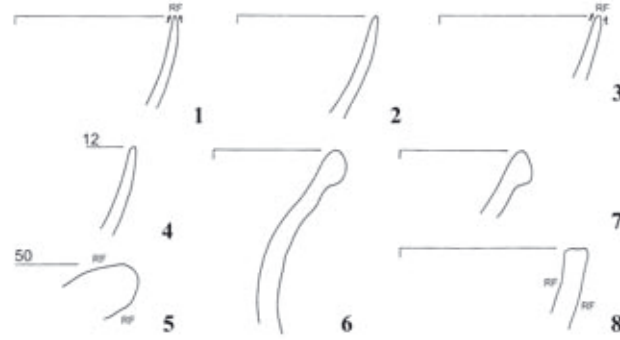

K7743

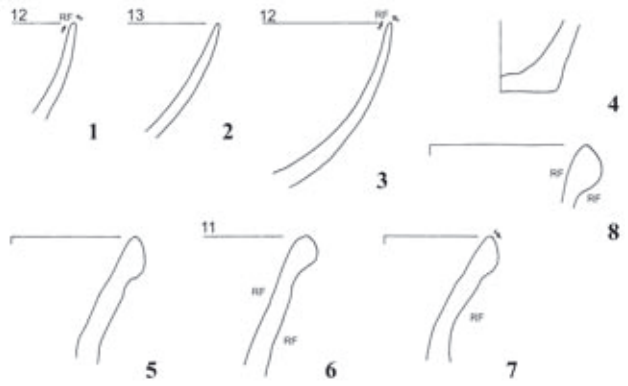

K7745

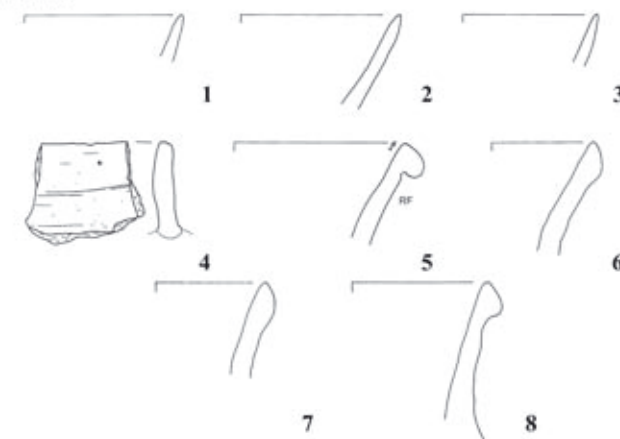

K7746



K7747

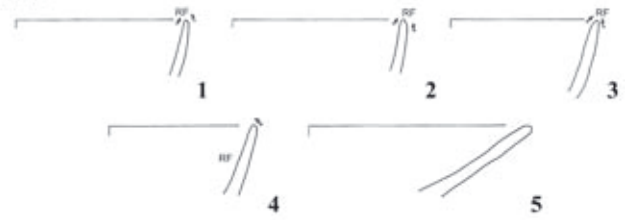

K7748

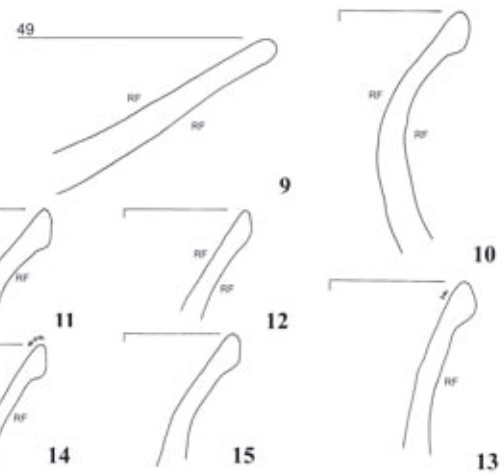
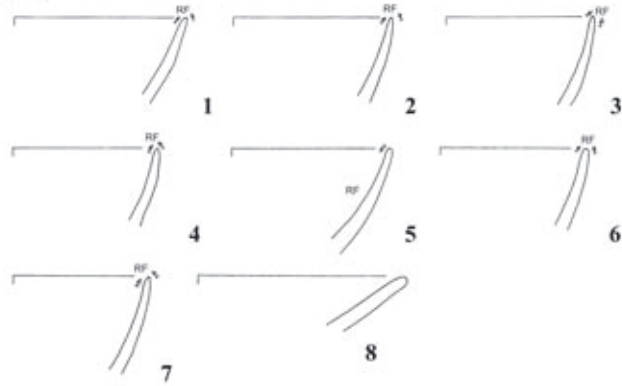

L31 (2)

Tafel 12

K7749

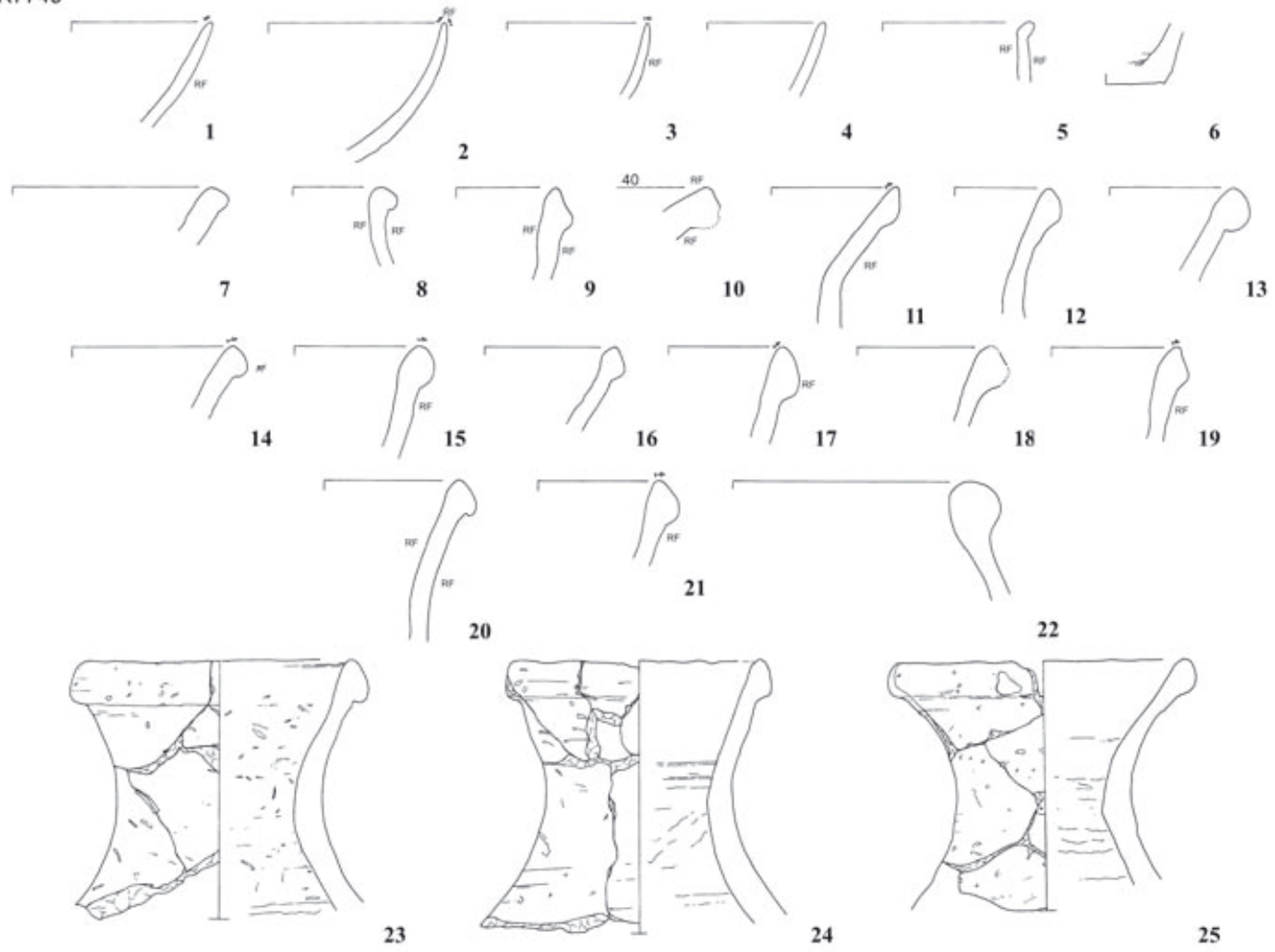

K7750

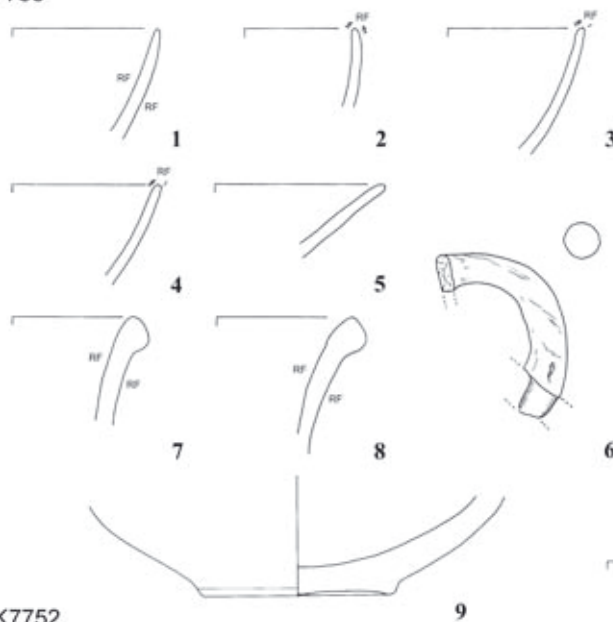

K7751

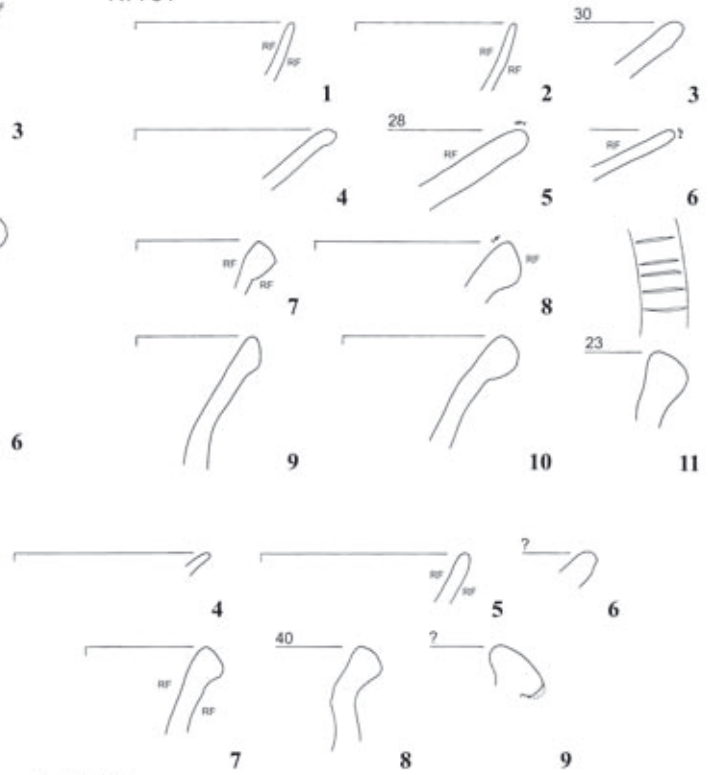

K7752

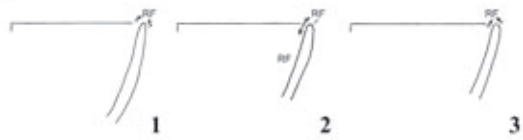

L31 (3)

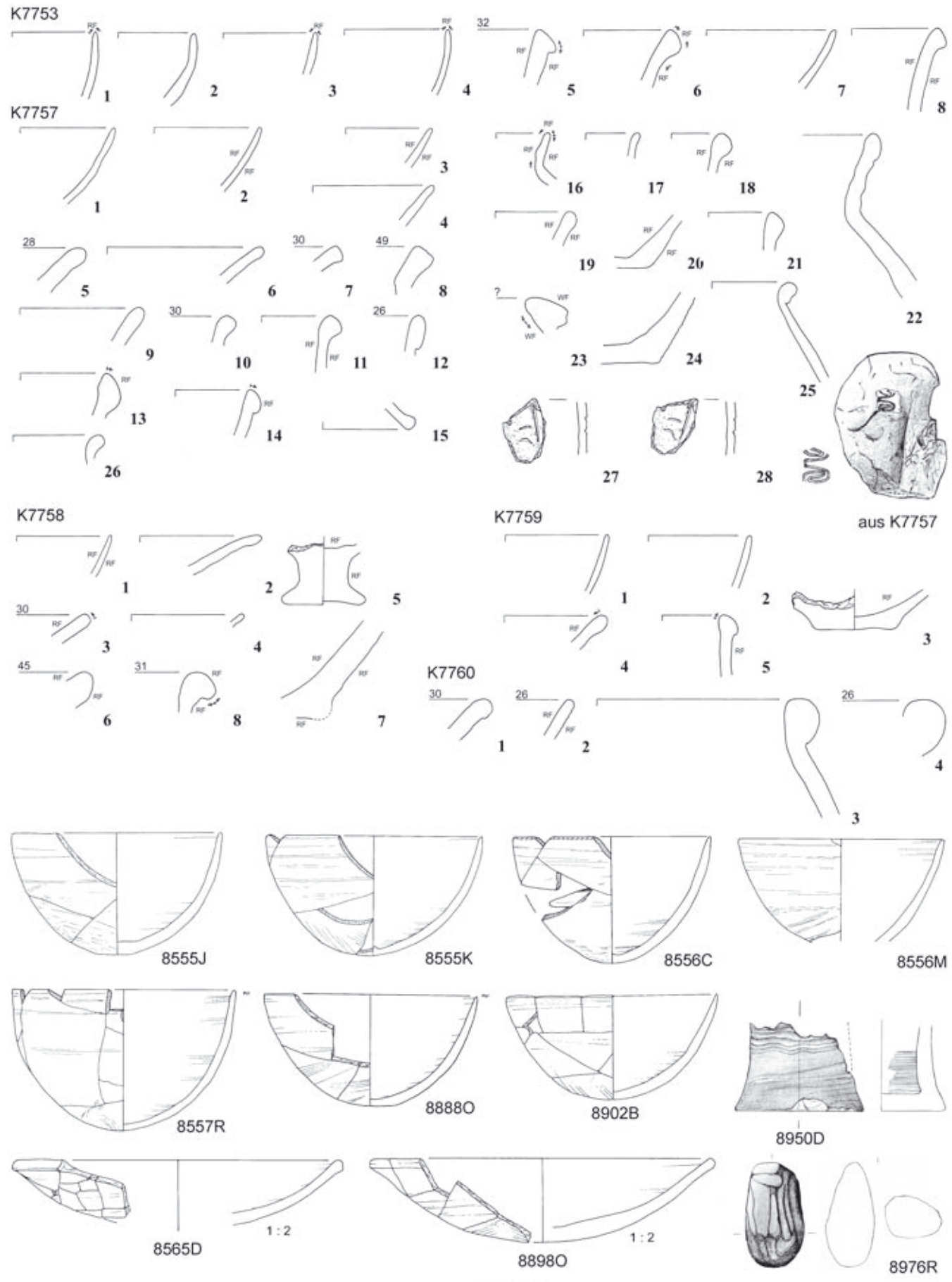



K7386A

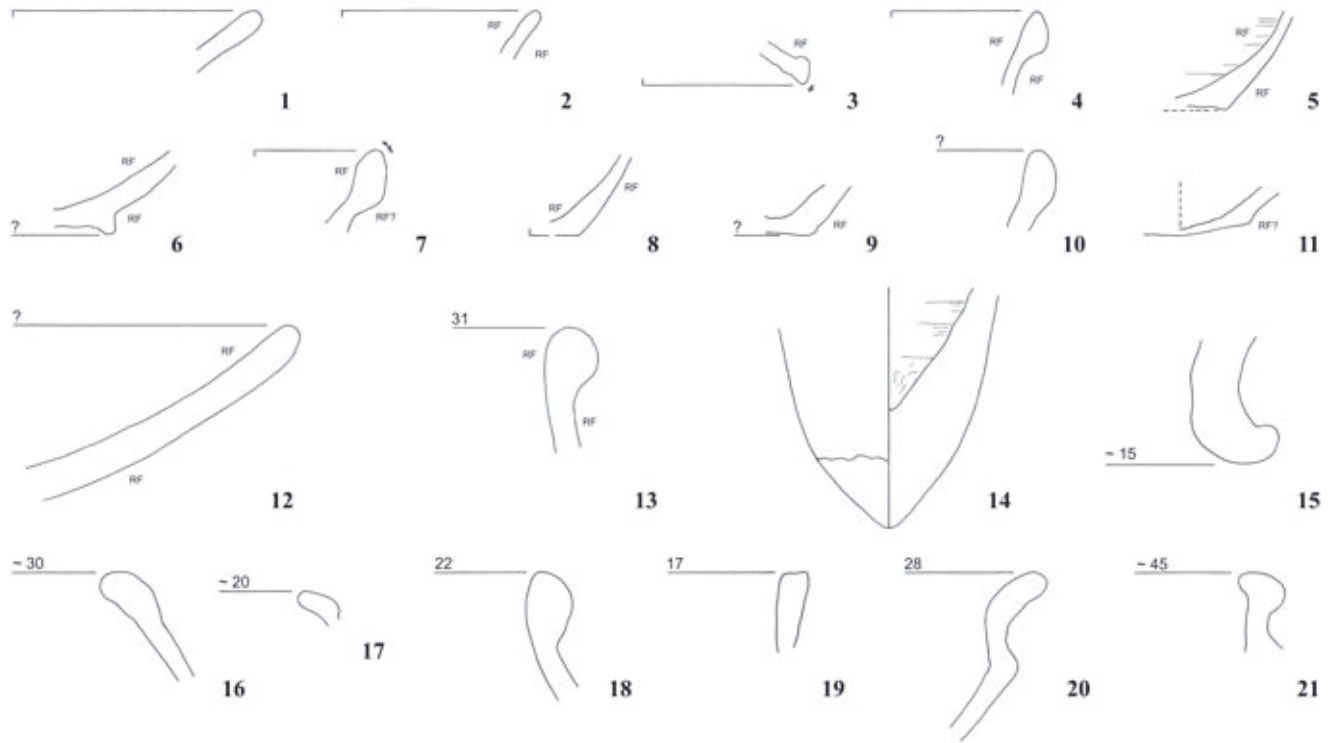

K7387

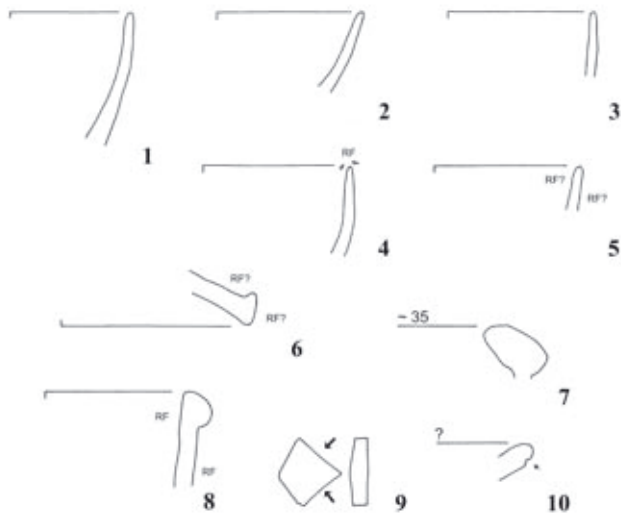

K7738

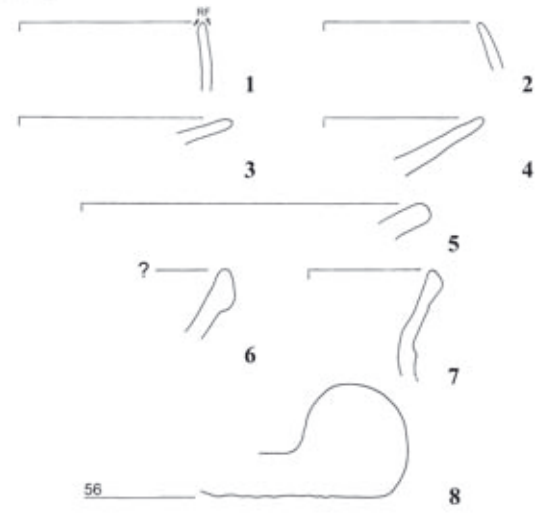

K7387A

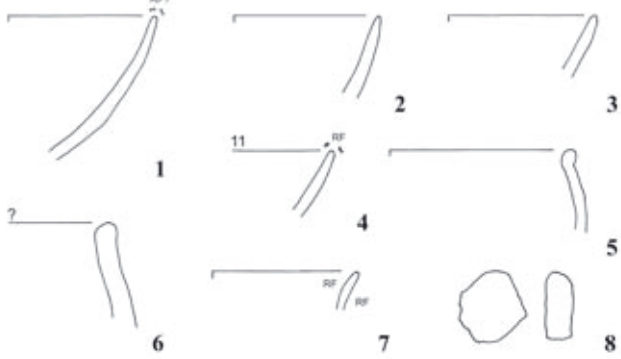

K7744

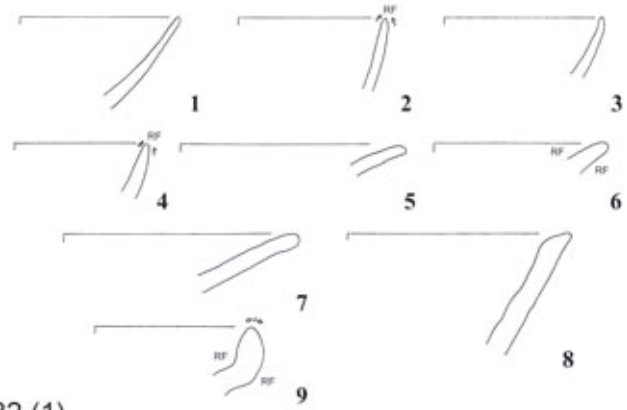

L32 (1)

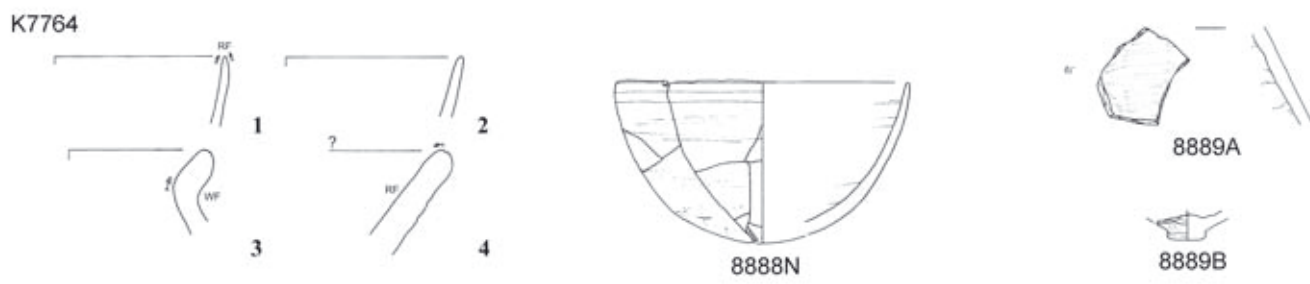
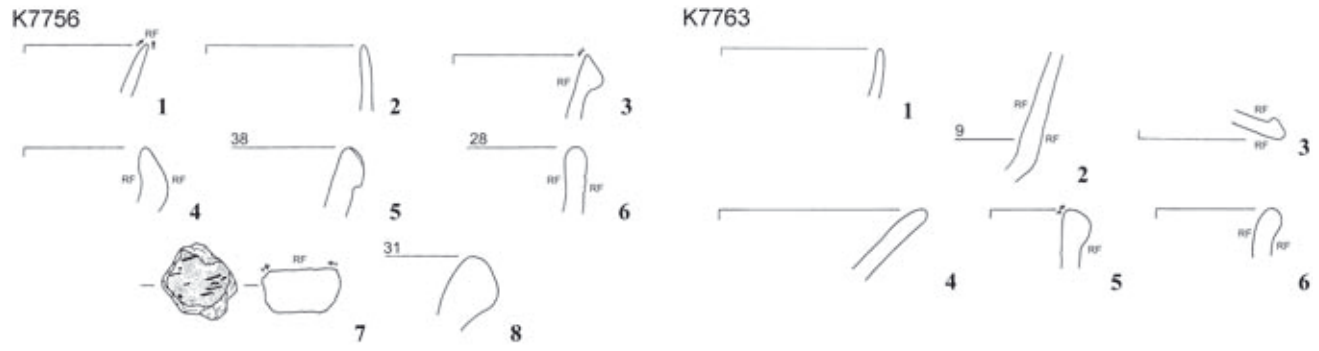

L32 (2)

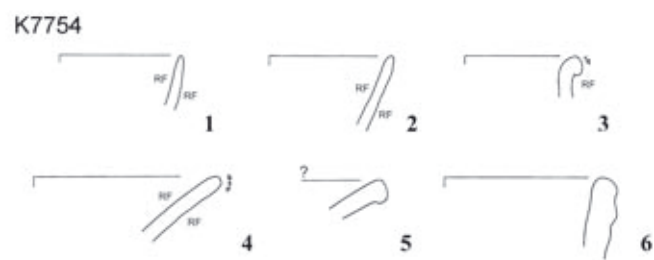
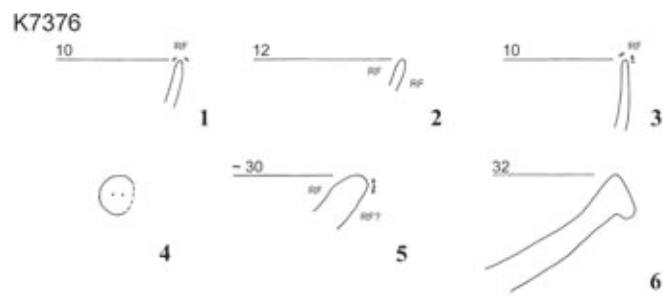

L34

K7376

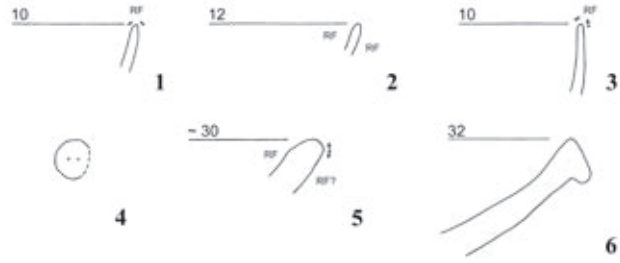

K7754

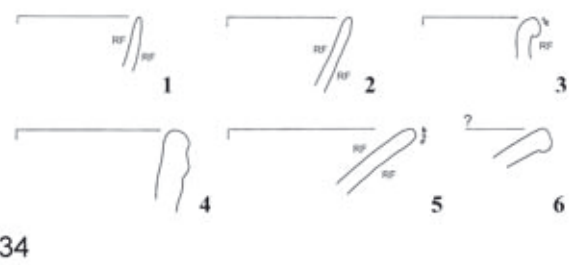

L34

K7855

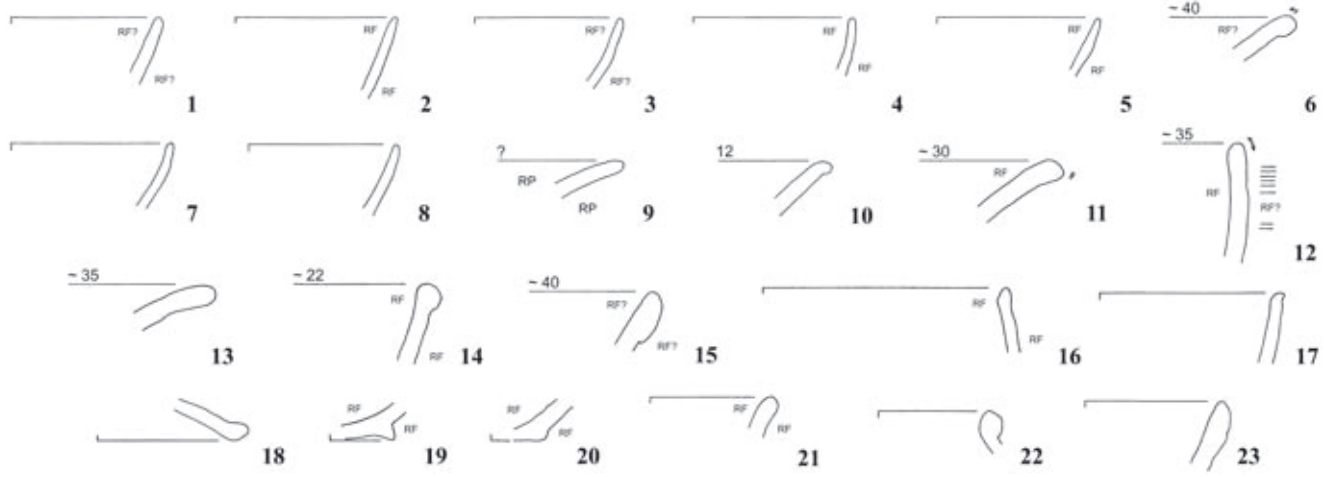

K7858

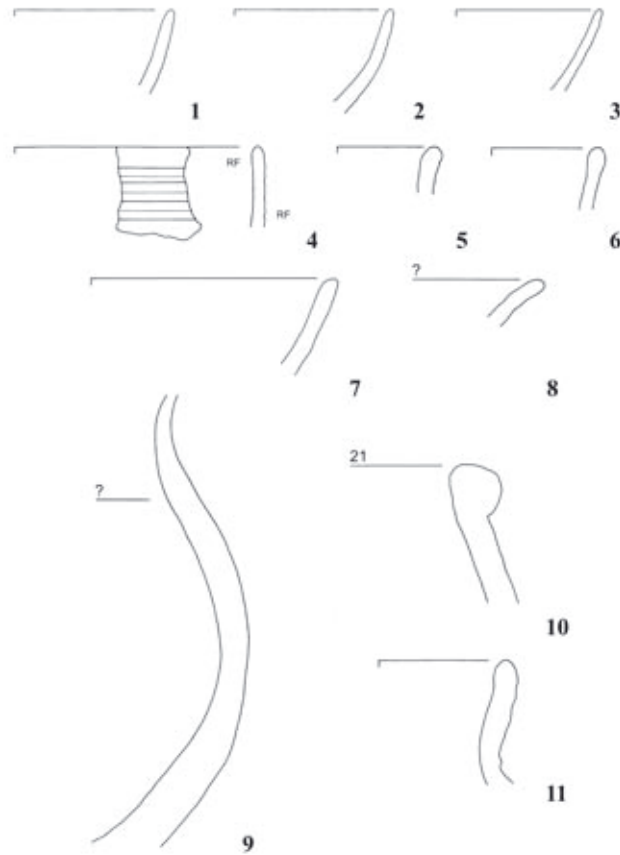

K7860

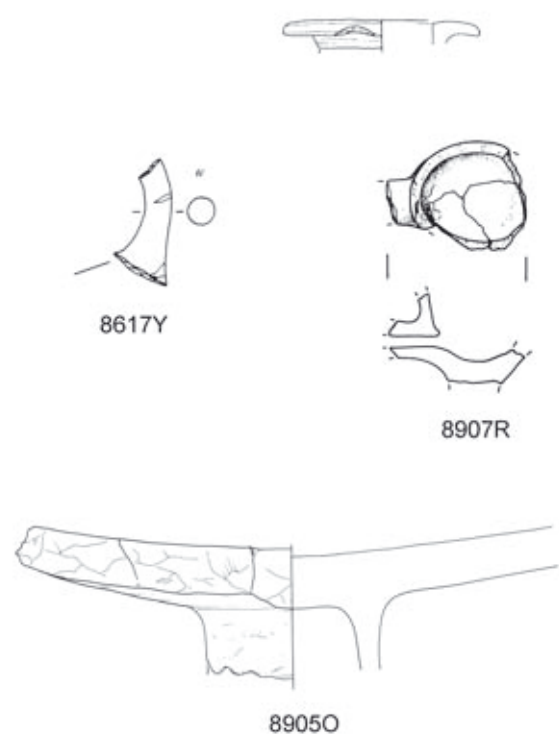

L35

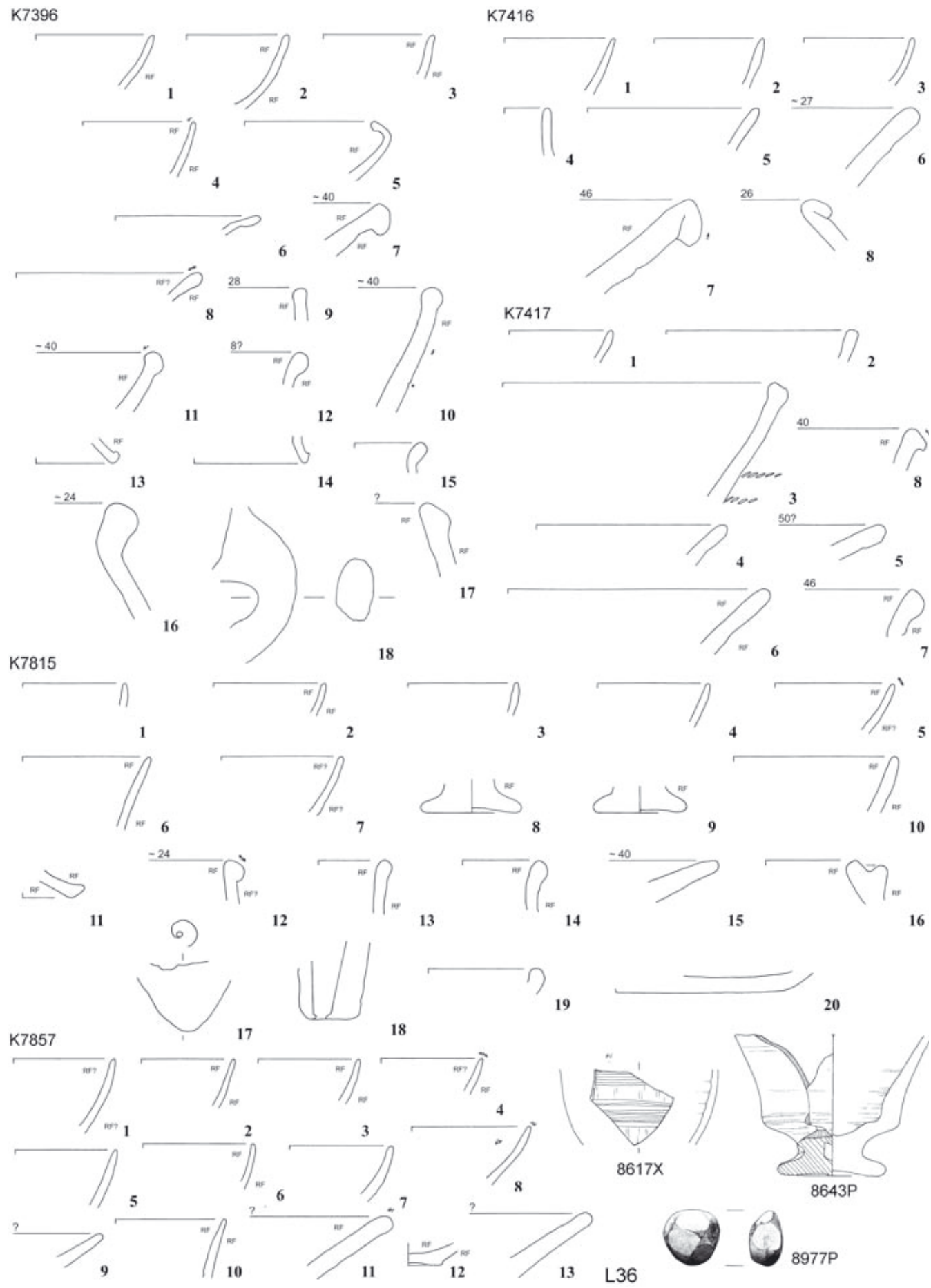

Tafel 18

K7307

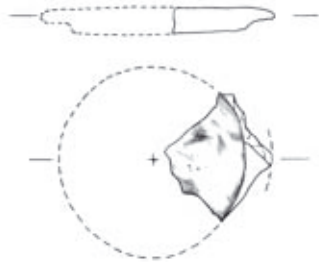
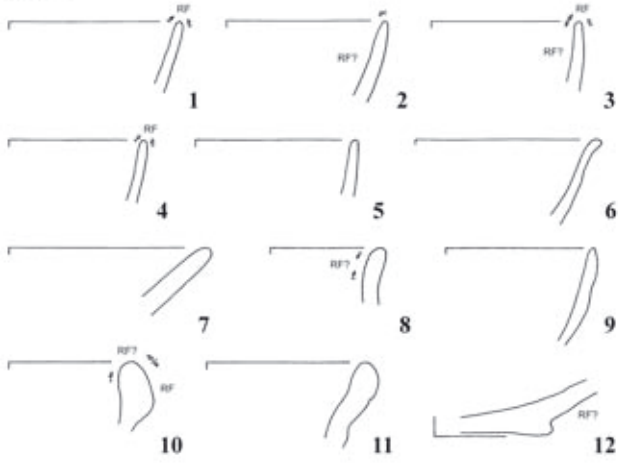

8950T

K7313

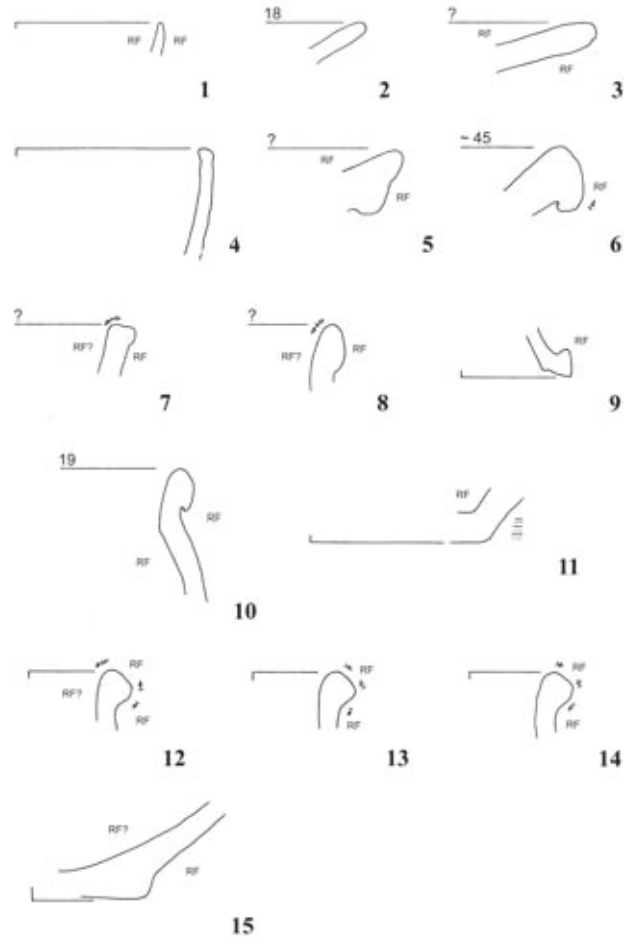

L37

Tafel 19

K8390

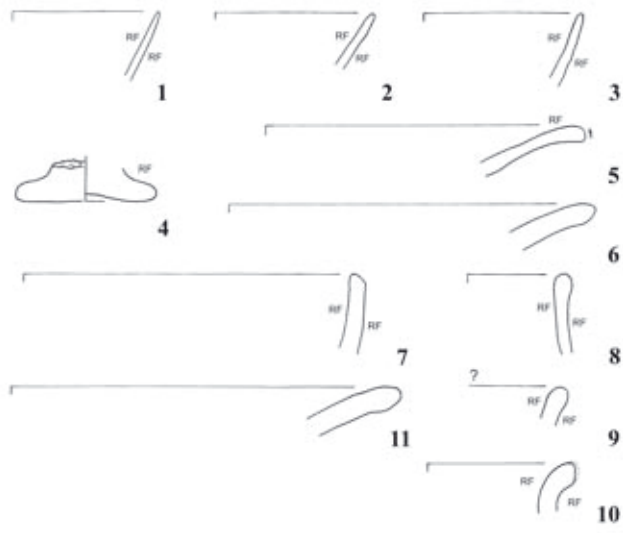

K8404

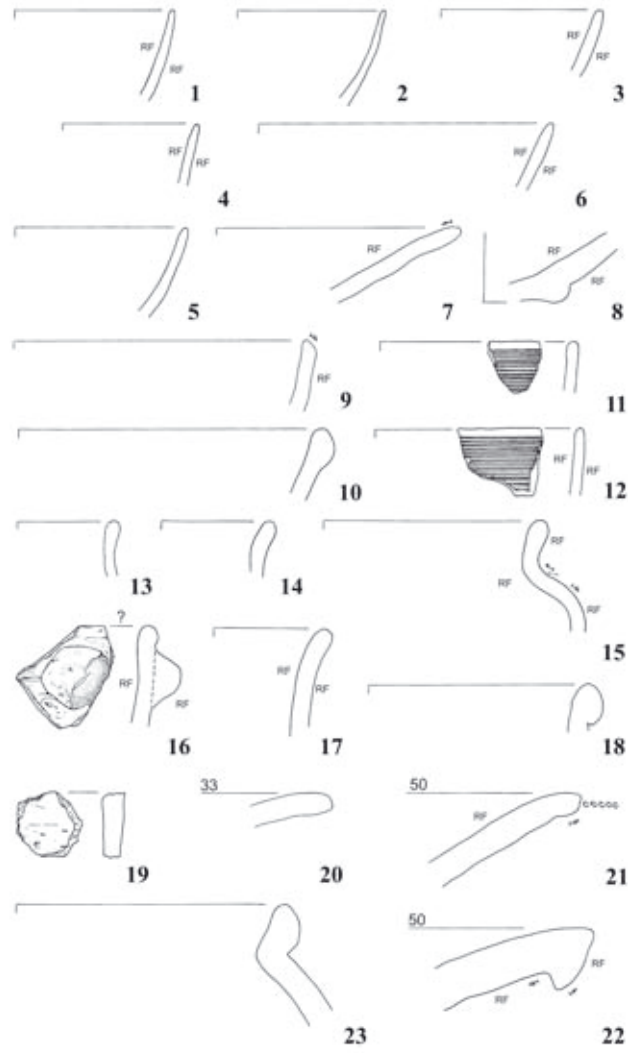

K8406

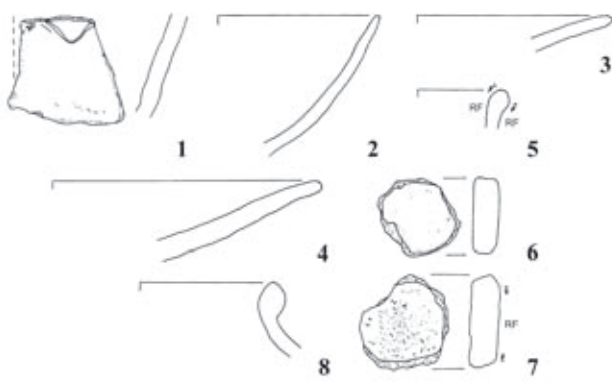

8556R

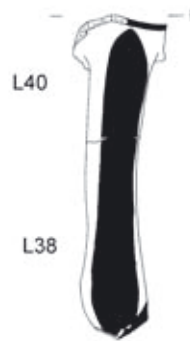

8558N/1+5



8885W



8977H

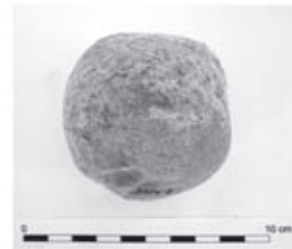

9504Z

L38

K8386

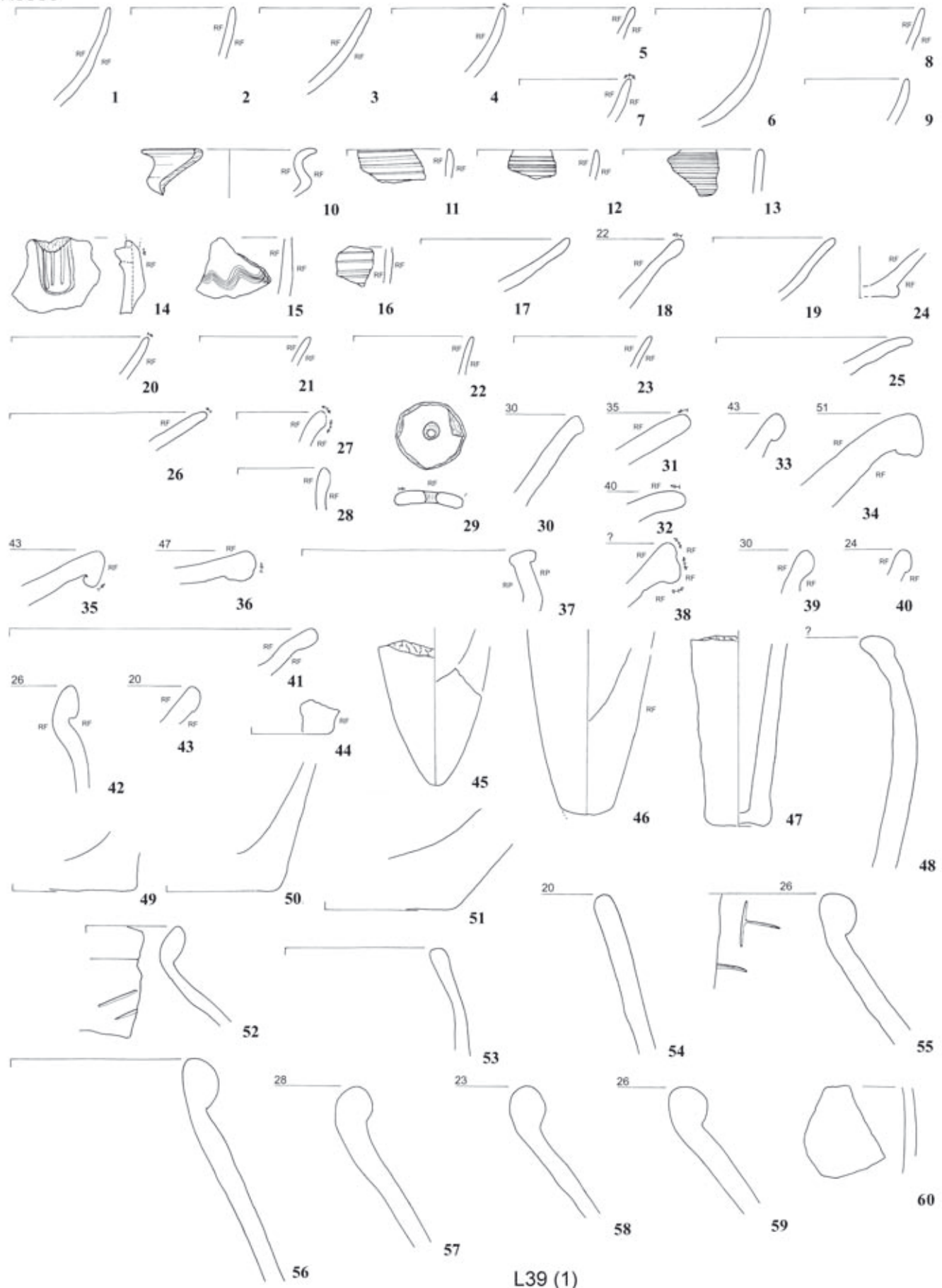



K8396

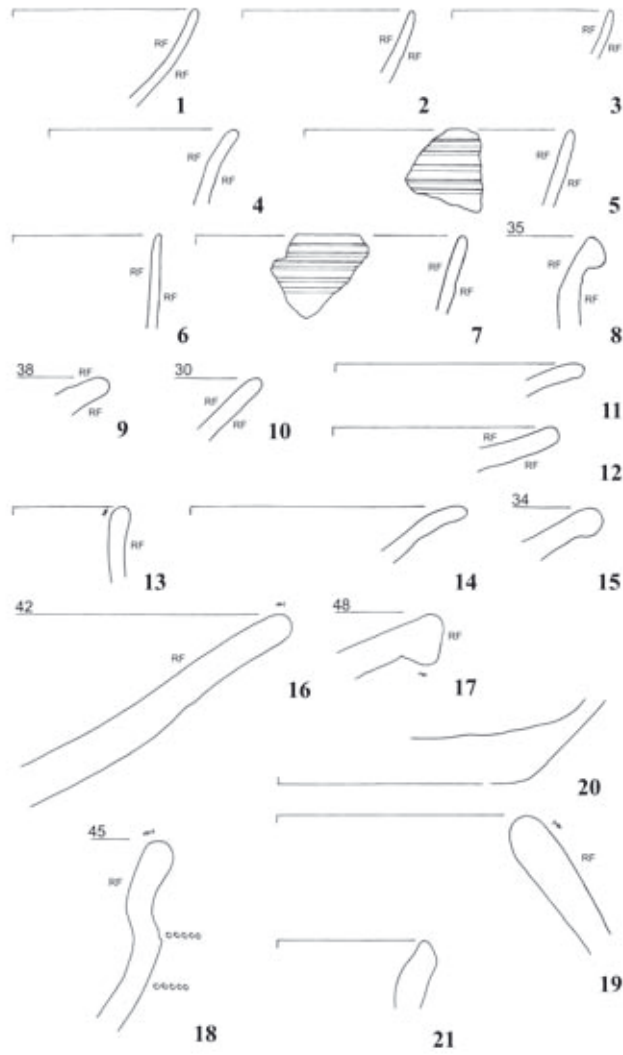

K8307

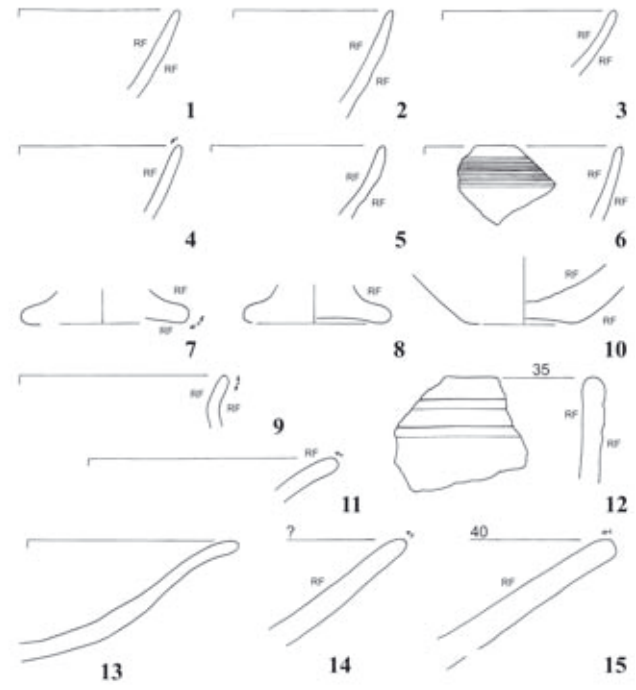

8885X

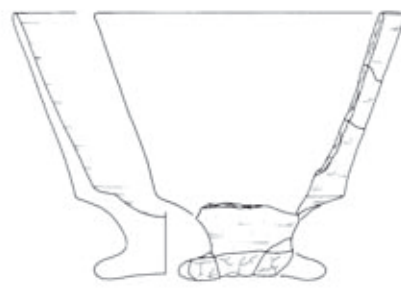

8928E



8949N



8561



K8397



8558M

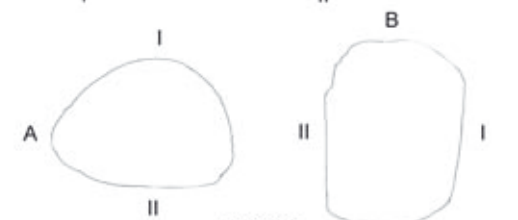
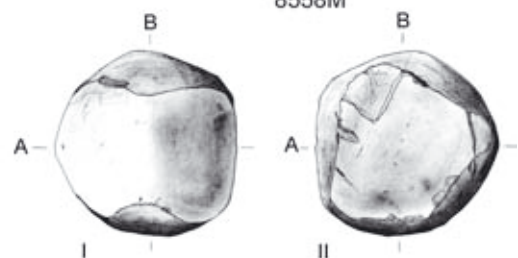

8976Y

L39 (2)





L39 (3)

Tafel 23

K8394

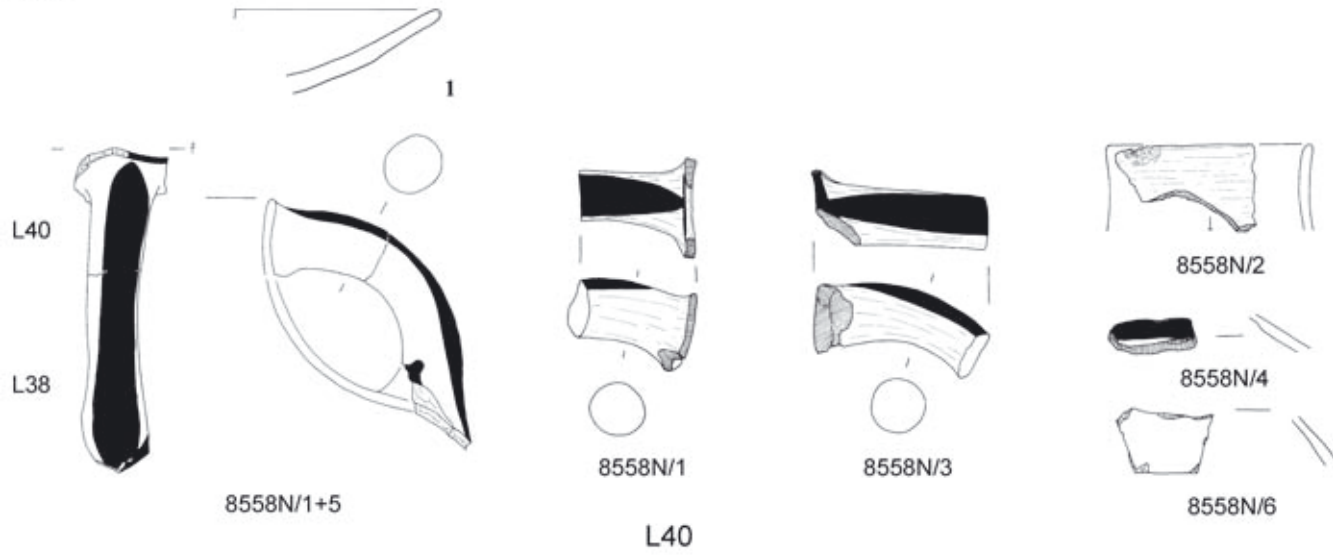

K7863



K7878

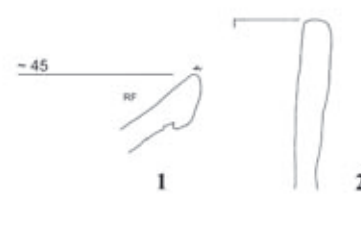

K7913

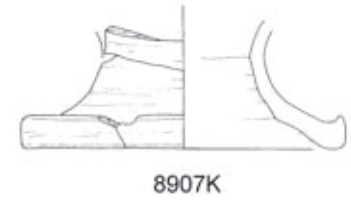
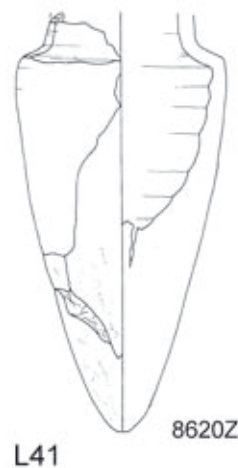
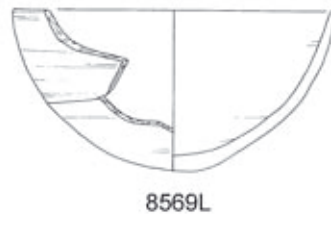
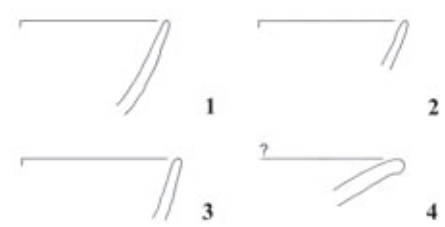

L41

K8128 (auch L46)

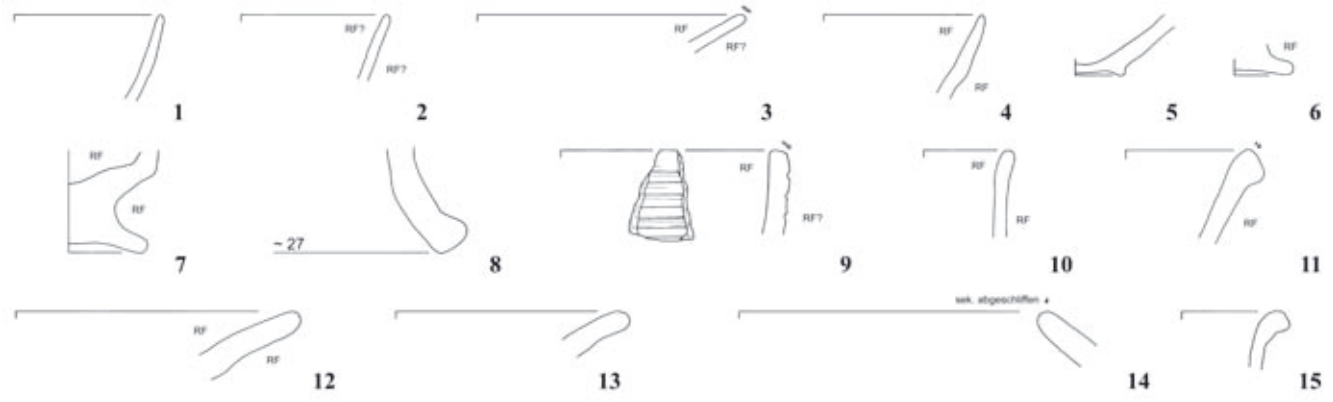

L45

K8388 (auch L580)

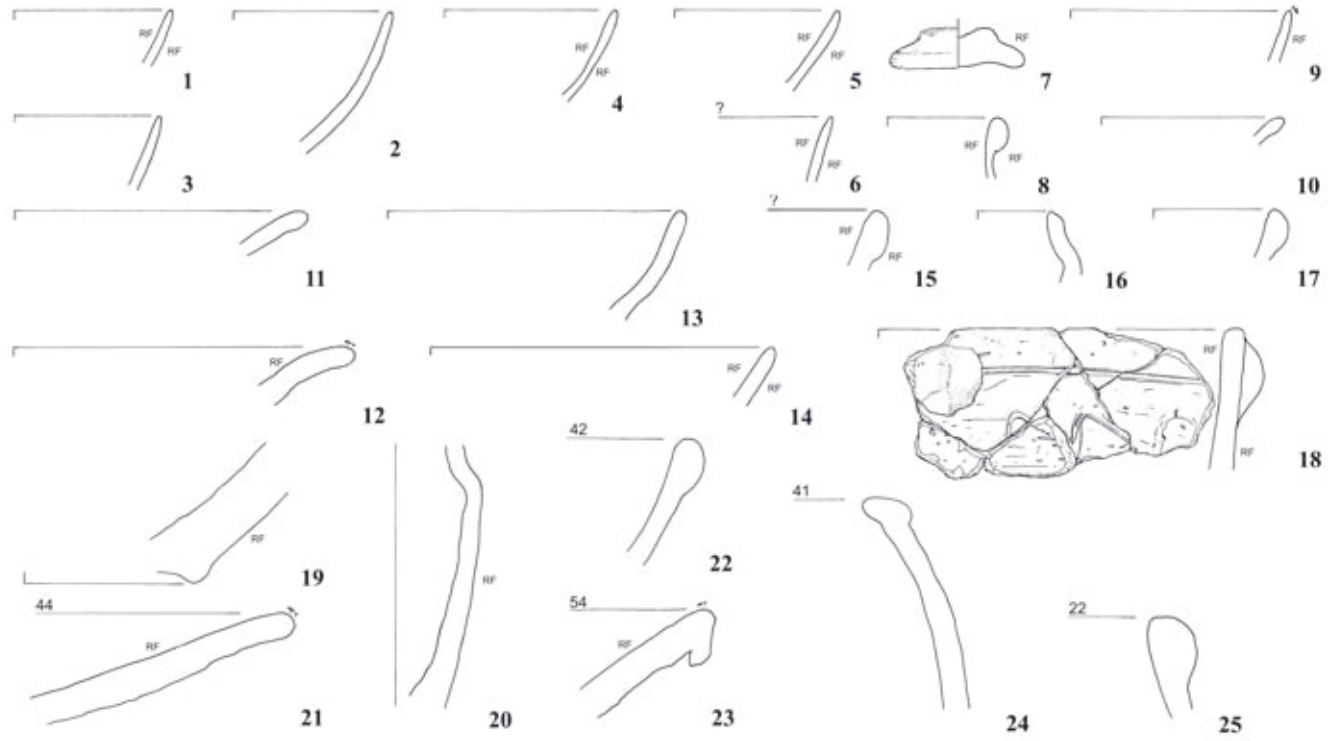

L8401

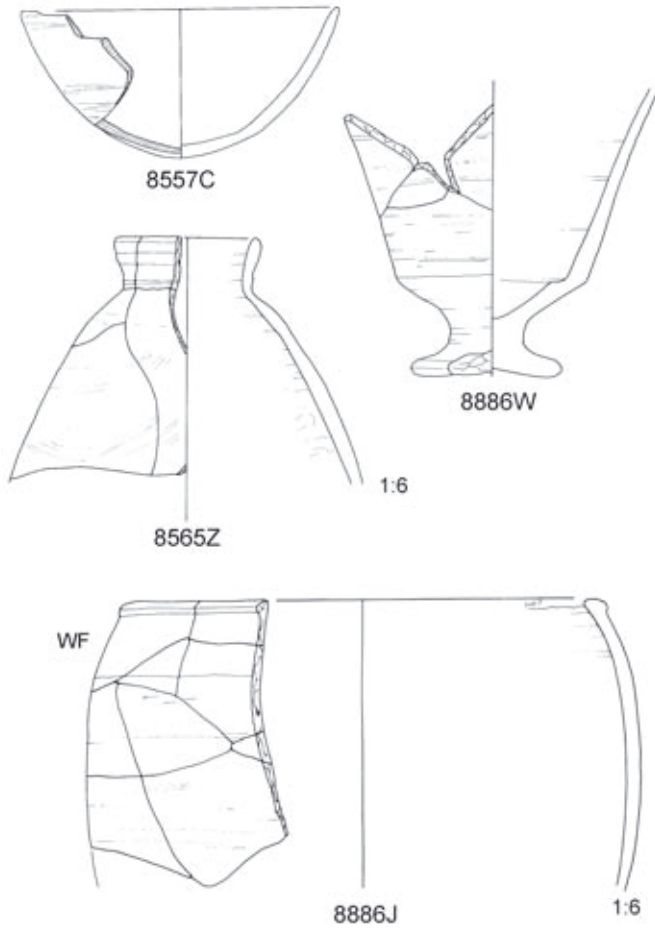
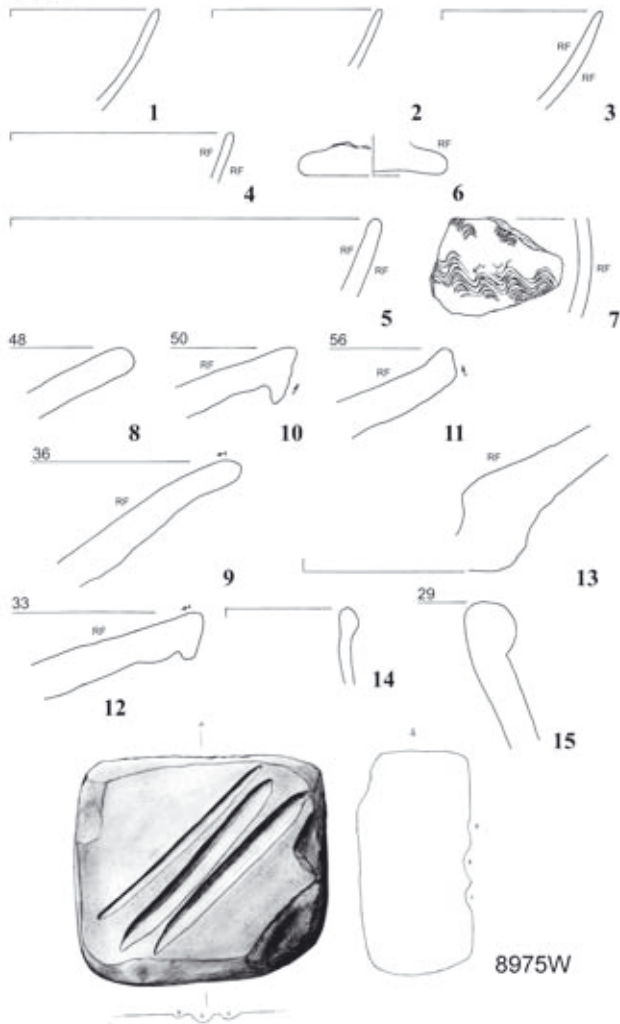

L47

K8398

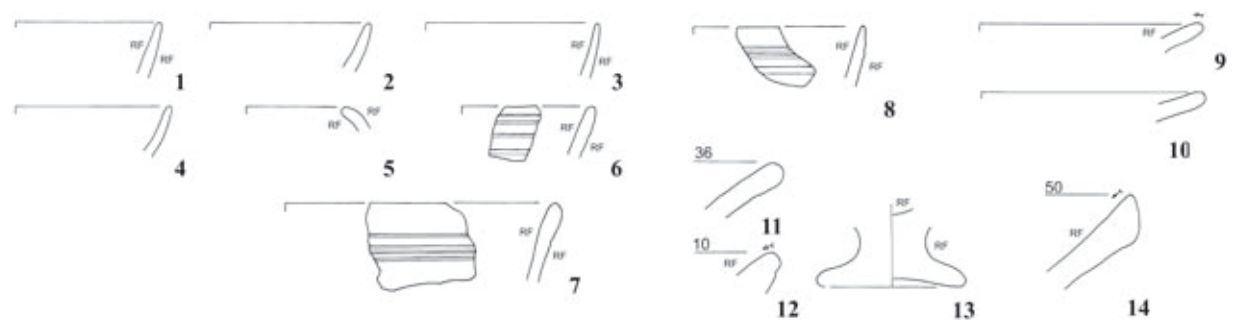

K8405

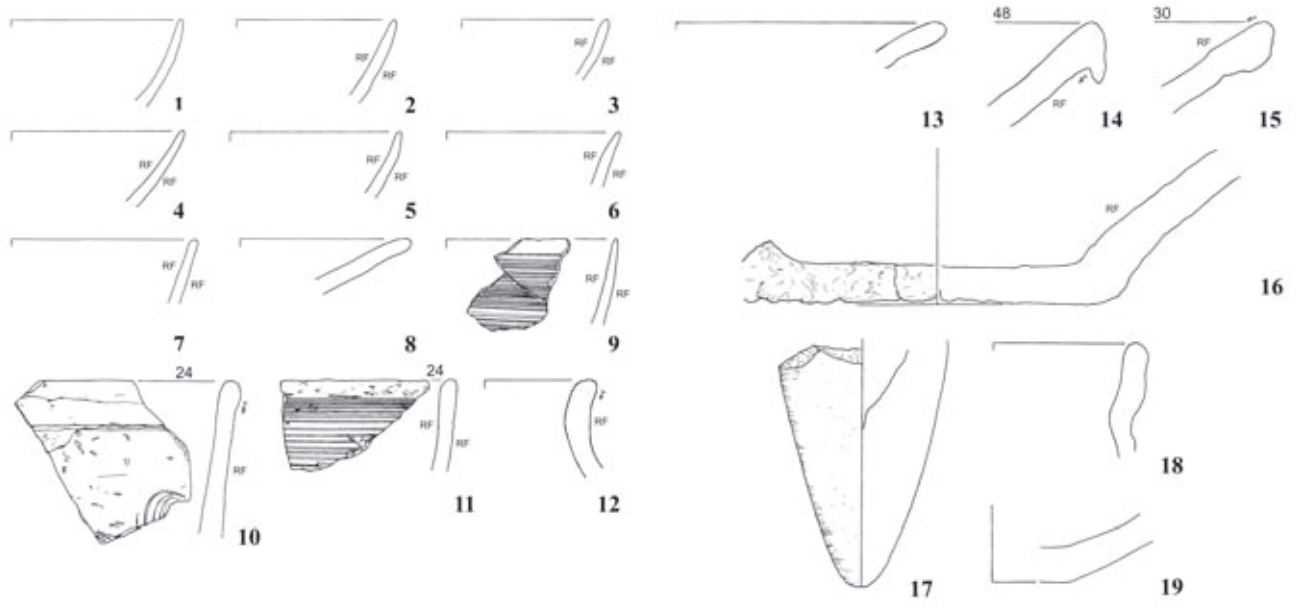

L48

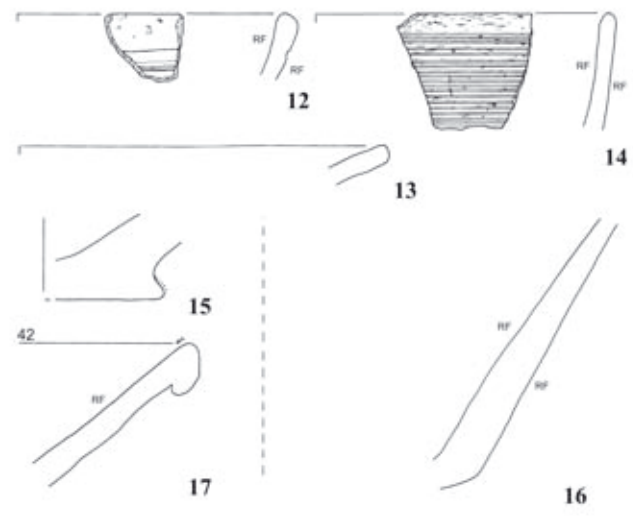

K8407

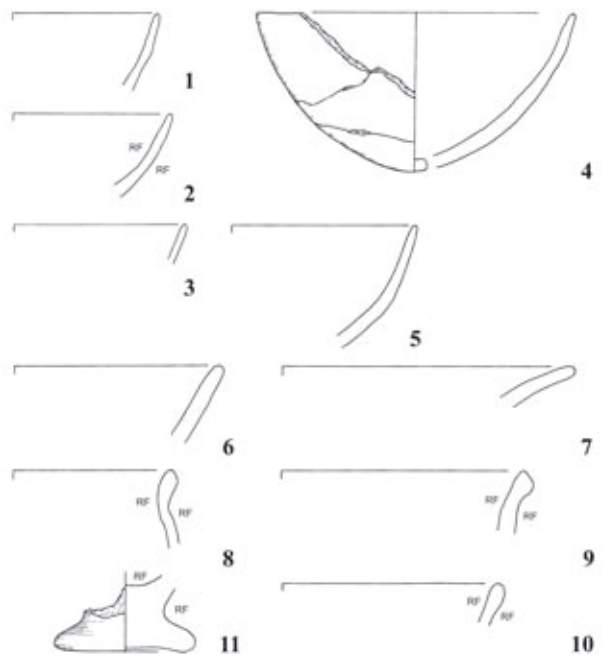

L50

K8408

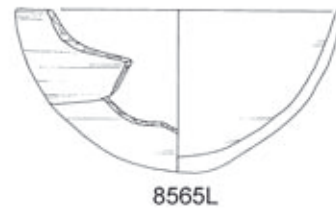
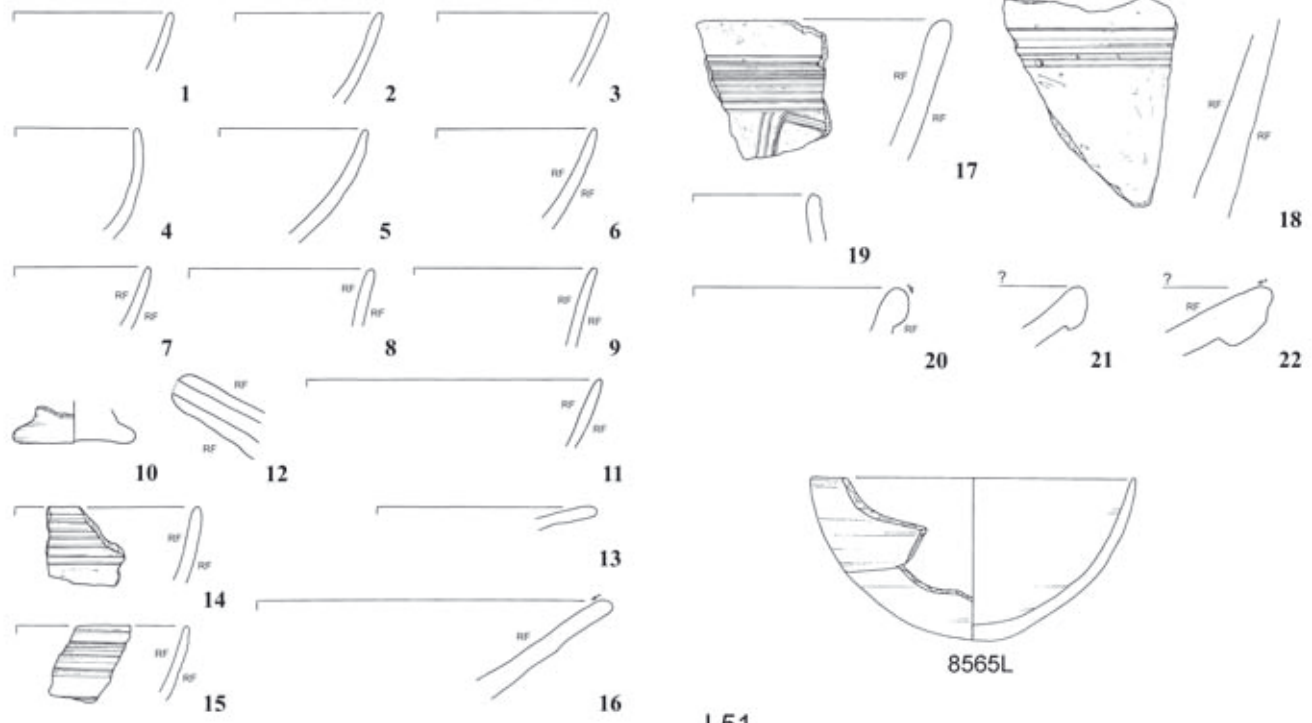

L51

K8409

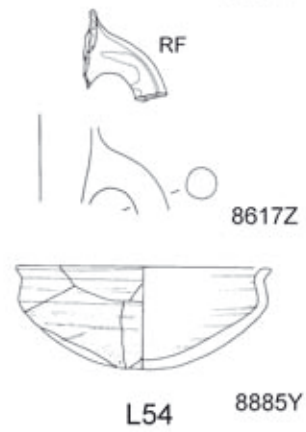
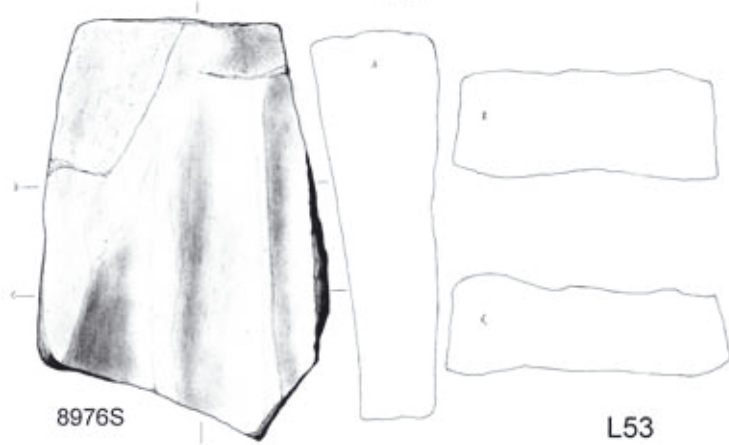
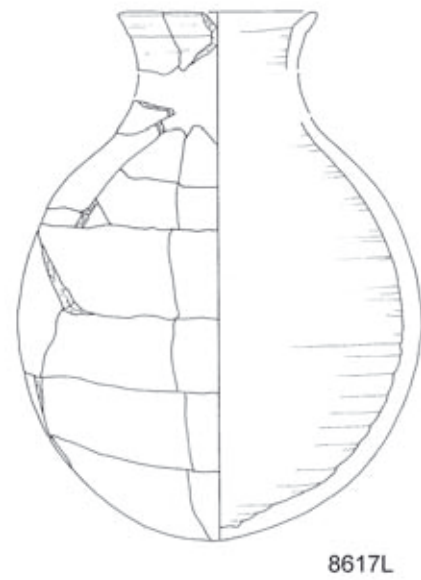
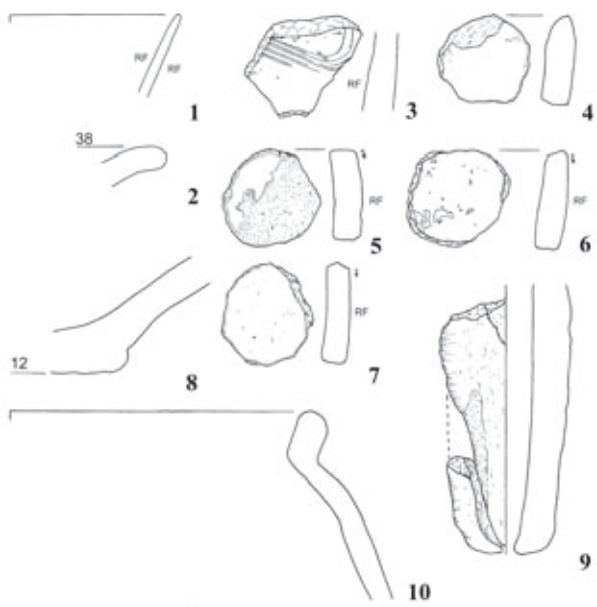



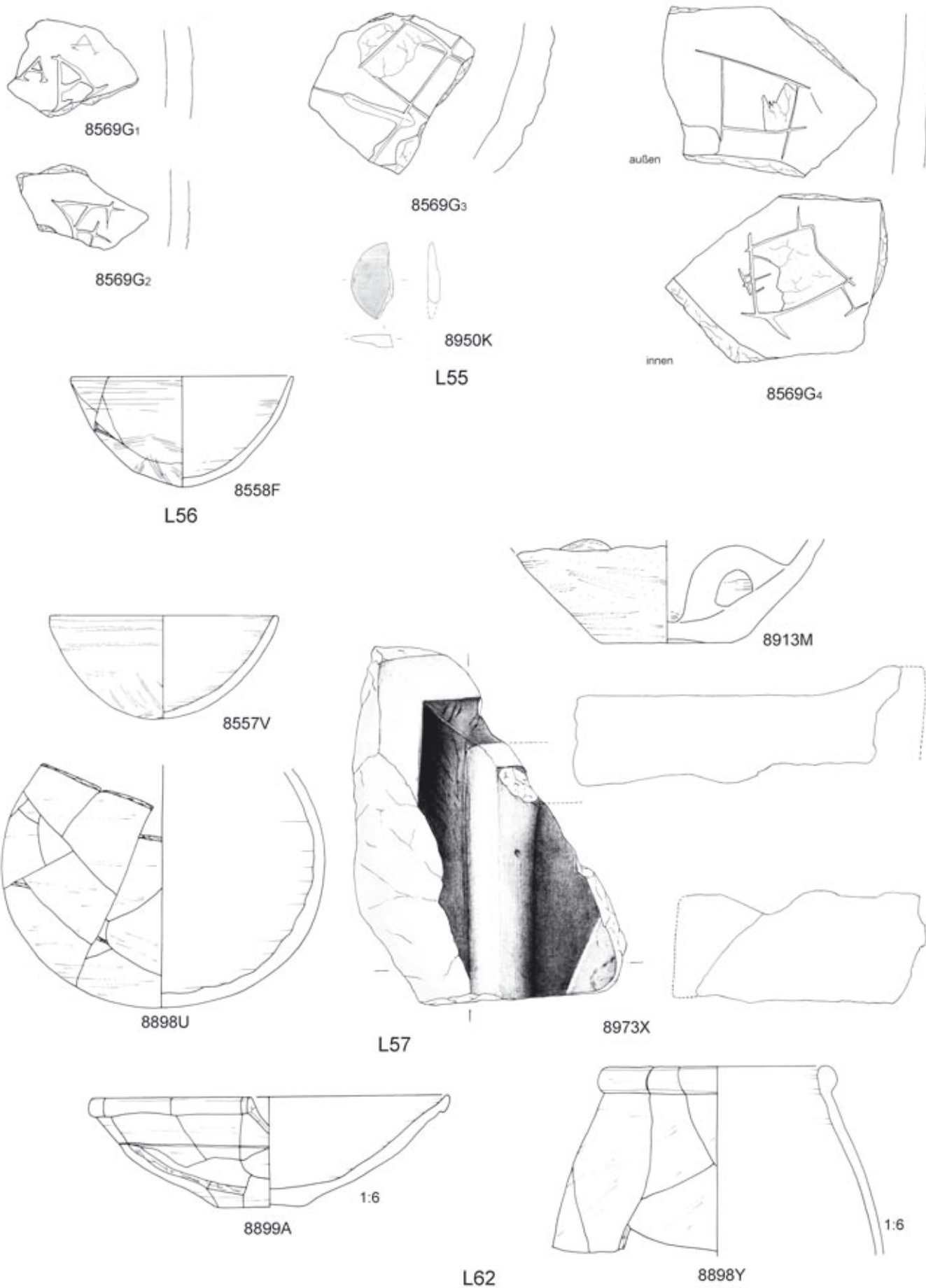

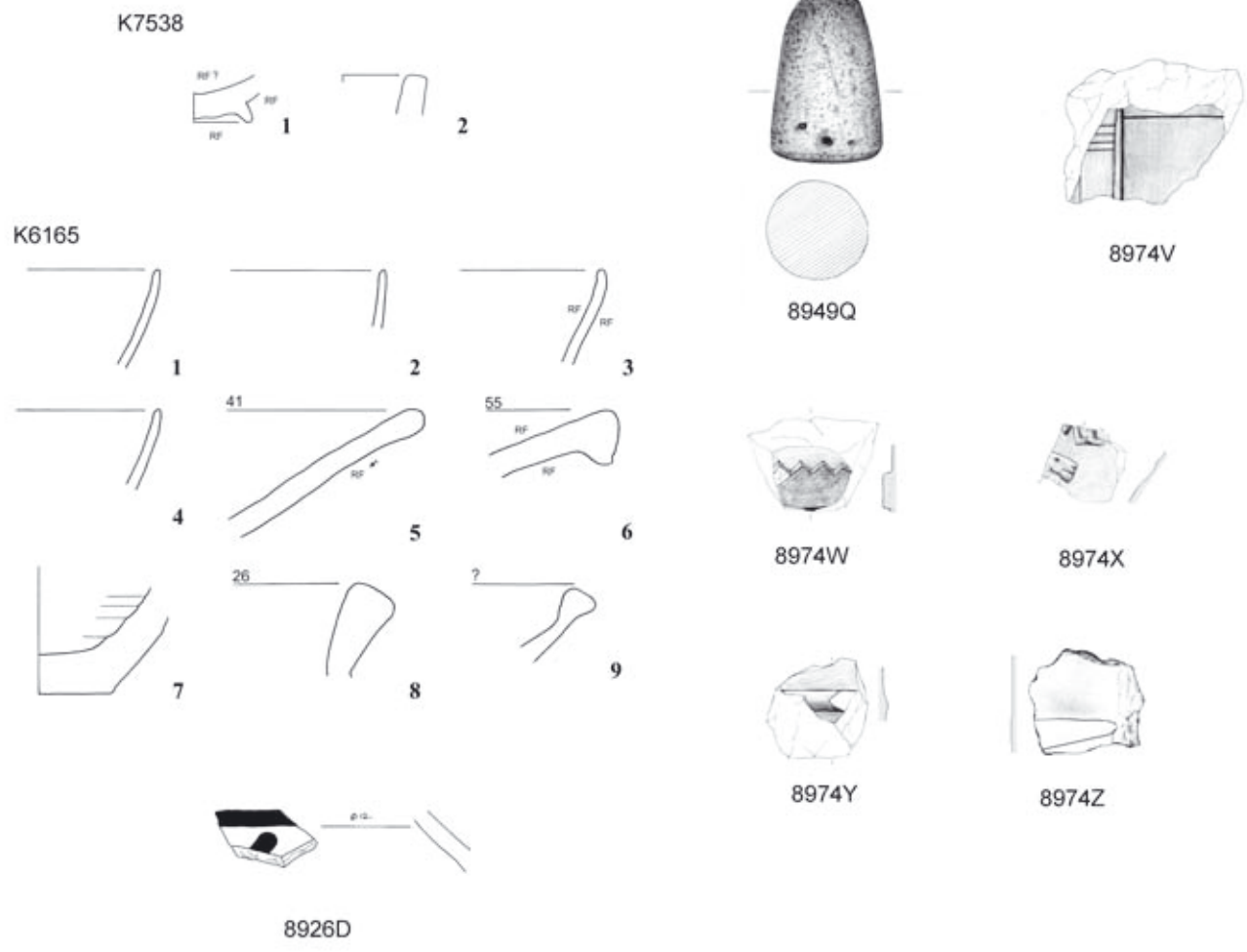

L76

Tafel 29





K7522

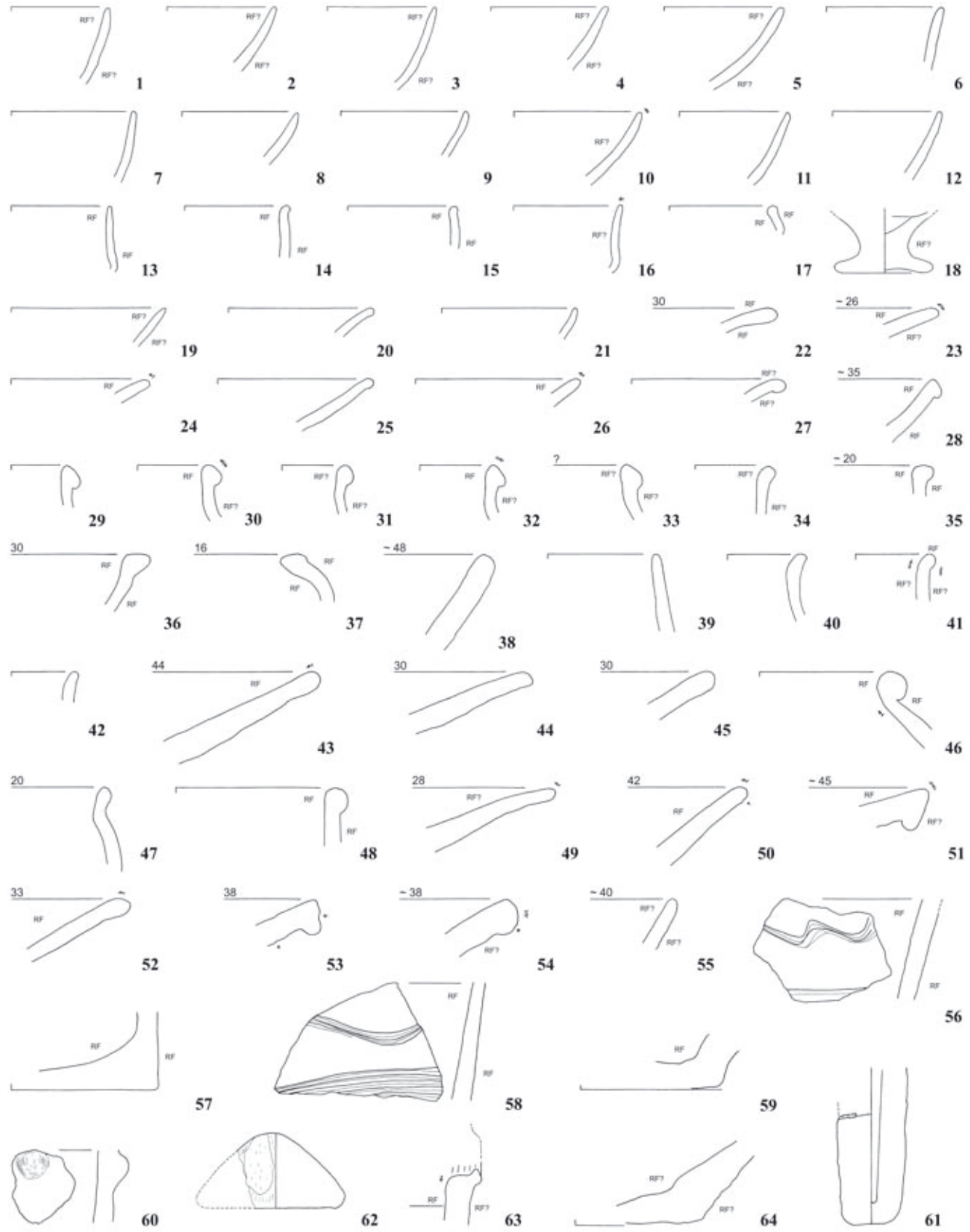

L77 (2)

K7522 (f.)

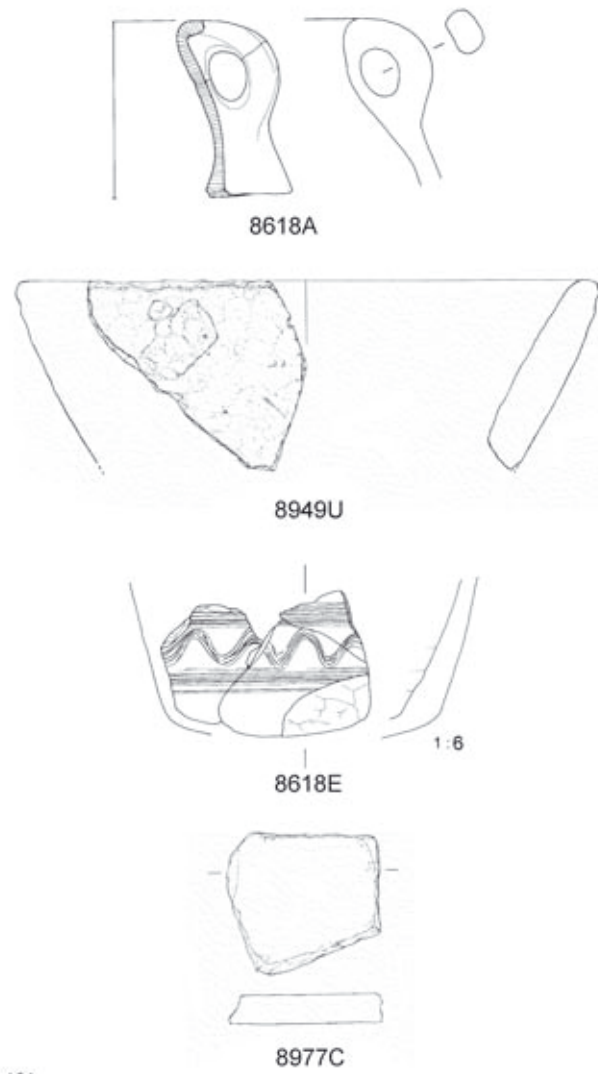
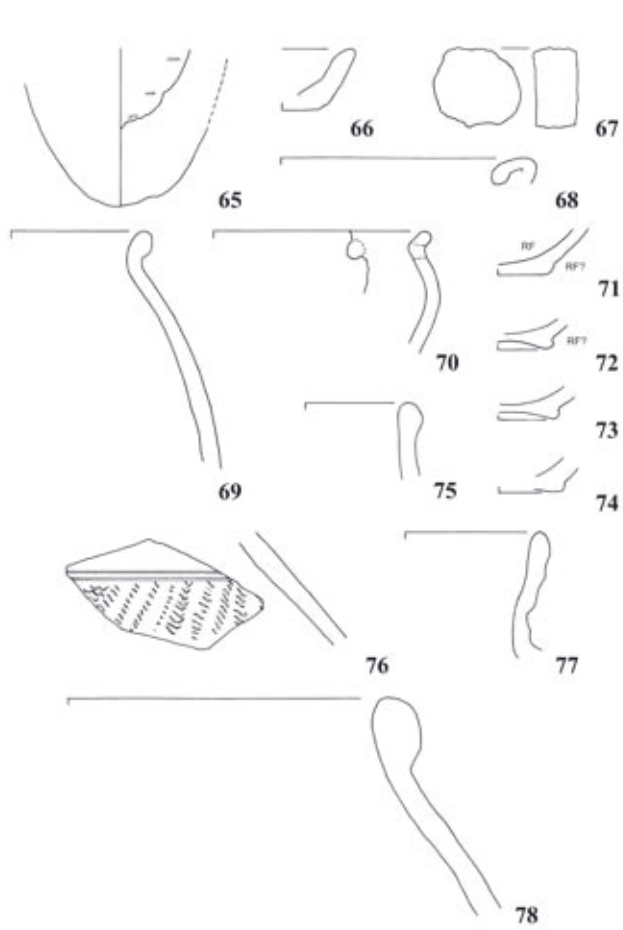

L77 (3)

K7388

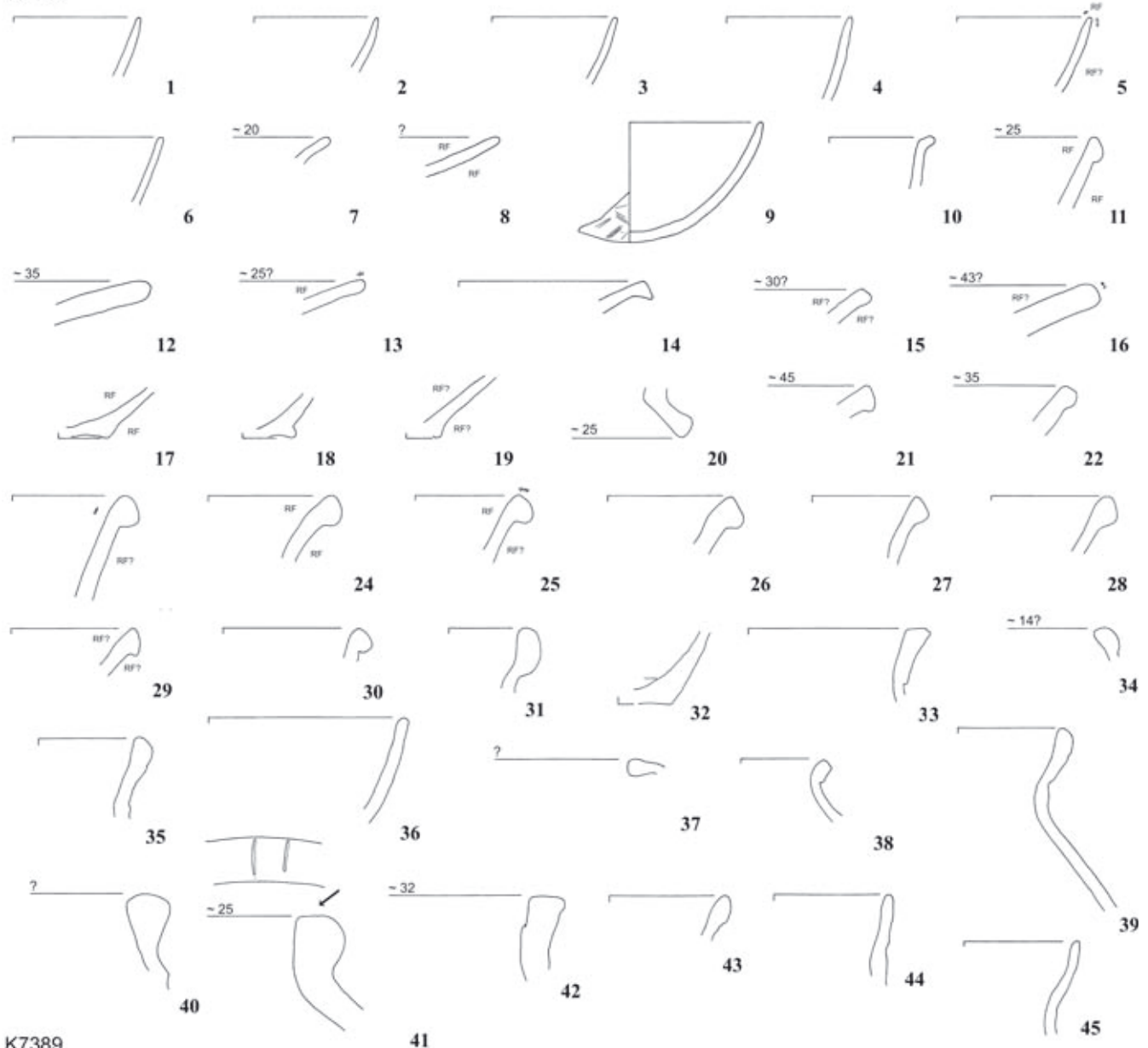

K7389

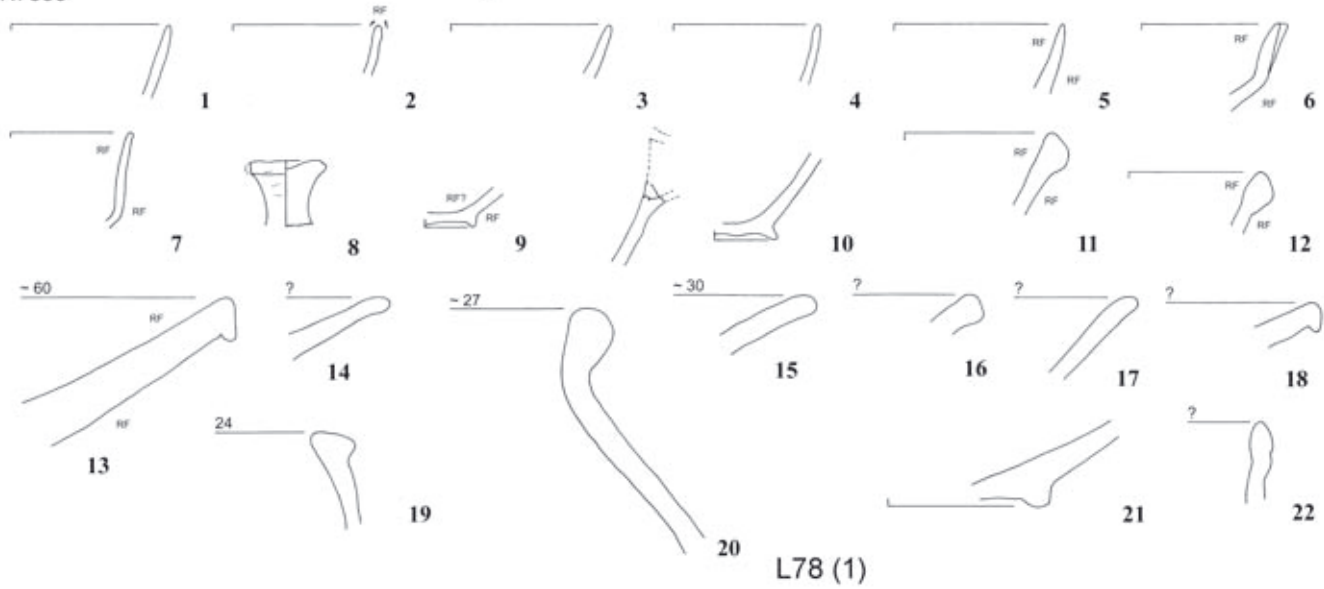

L78 (1)

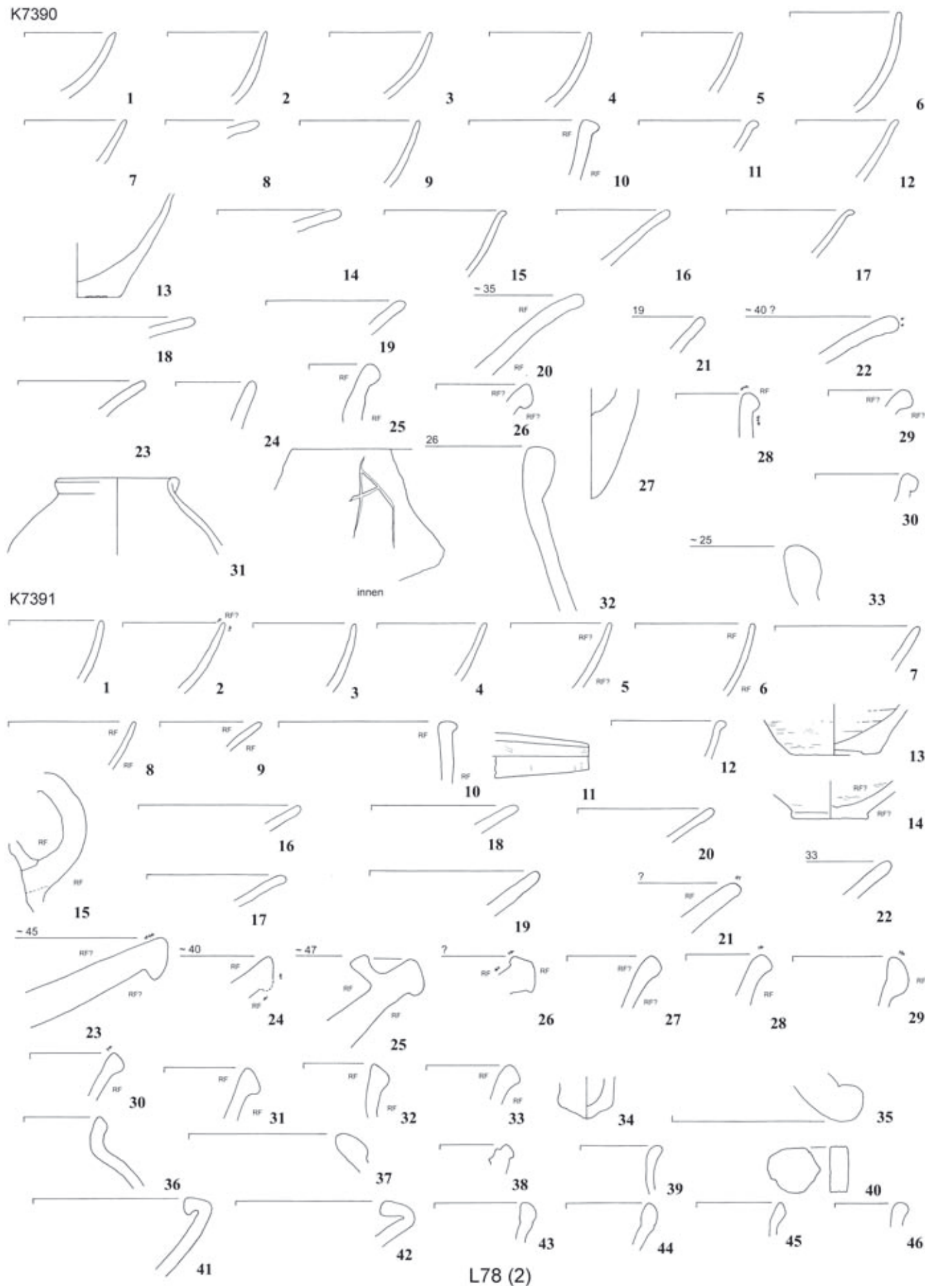

Tafel 34

K7392

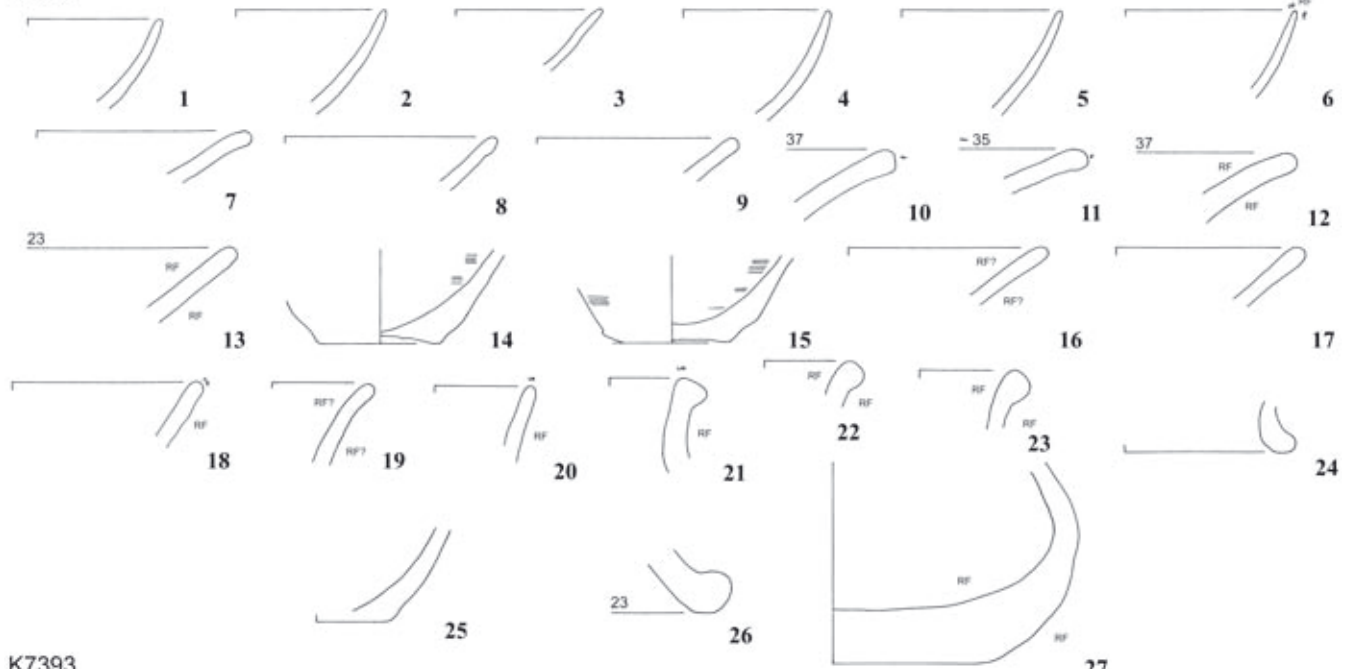

K7393

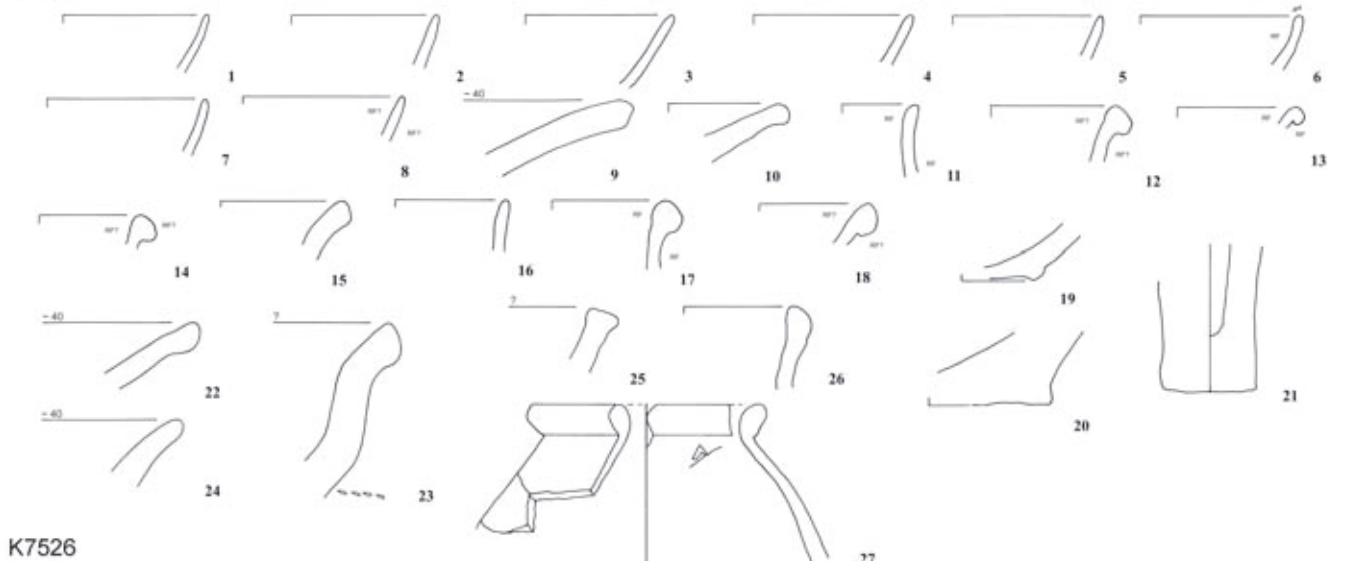

K7526

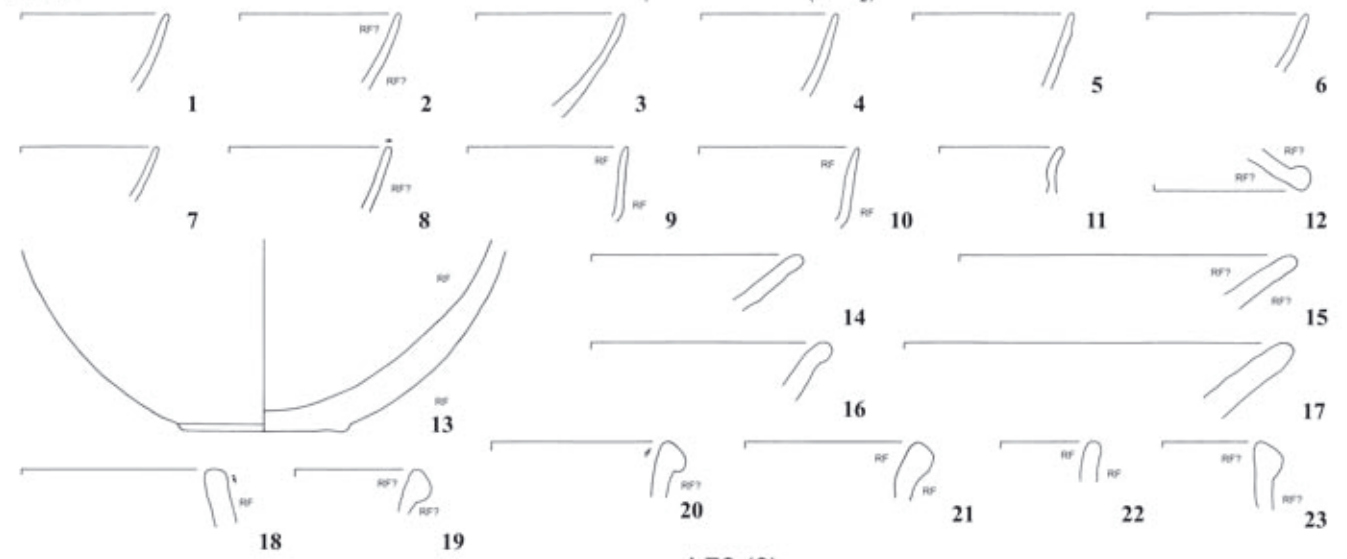

L78 (3)

K7526 f.

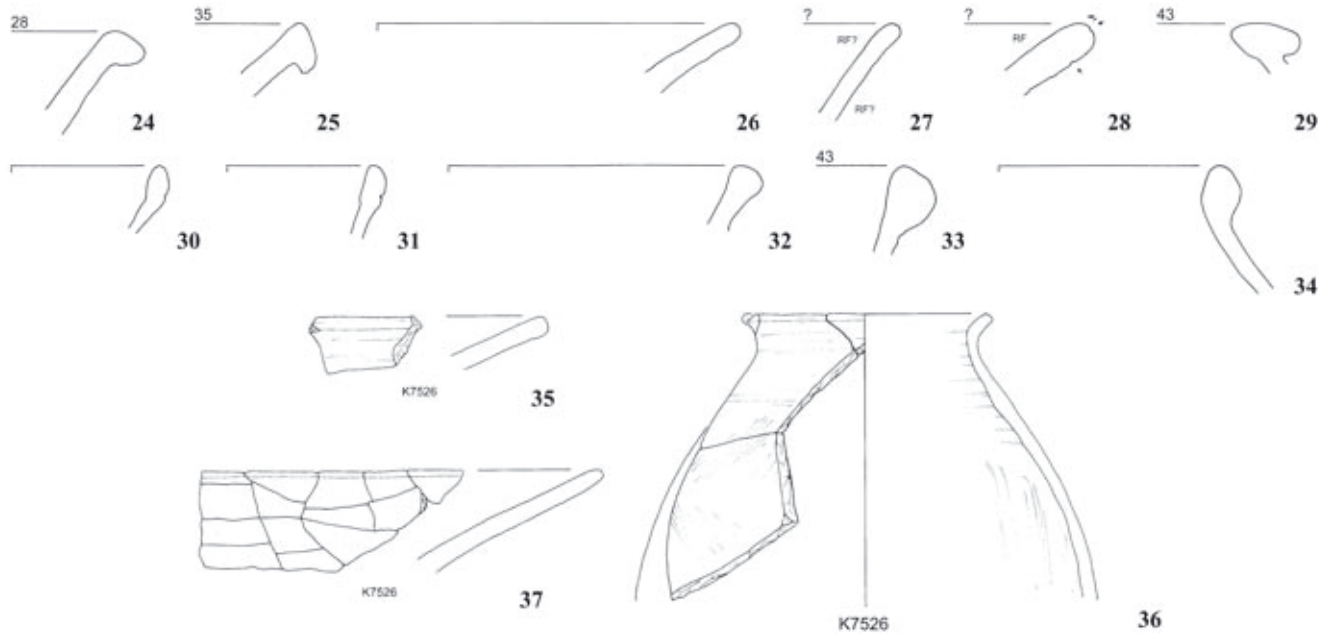

K7527

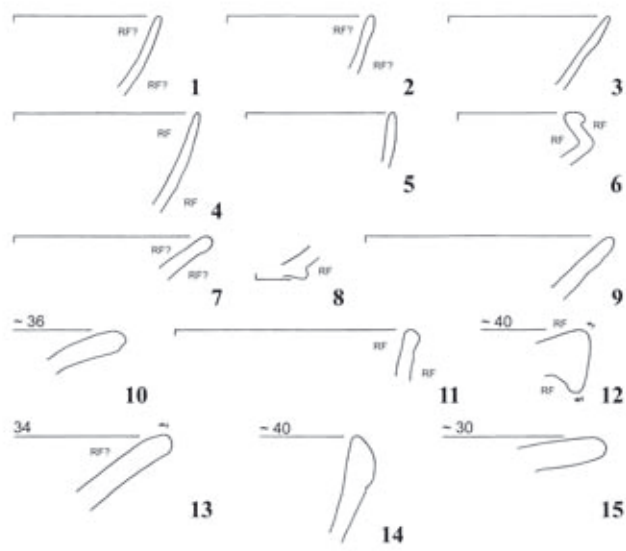

K7528

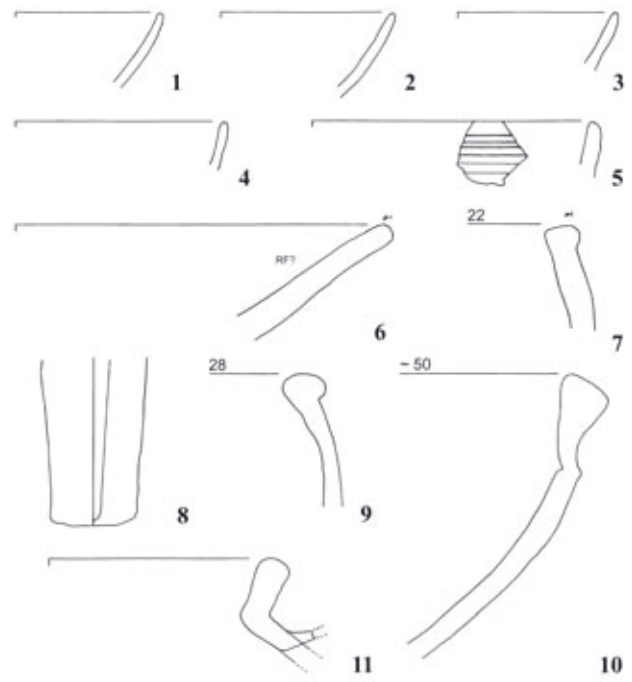

K7529

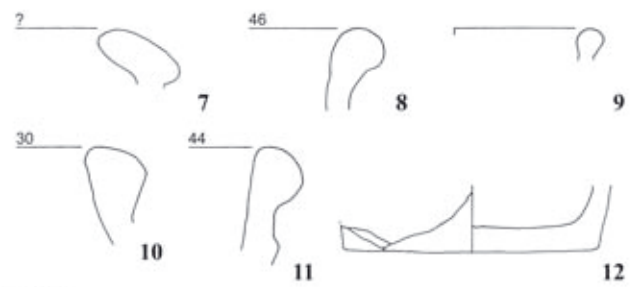
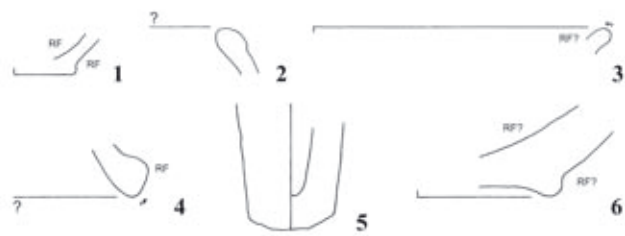

L78 (4)



K7530

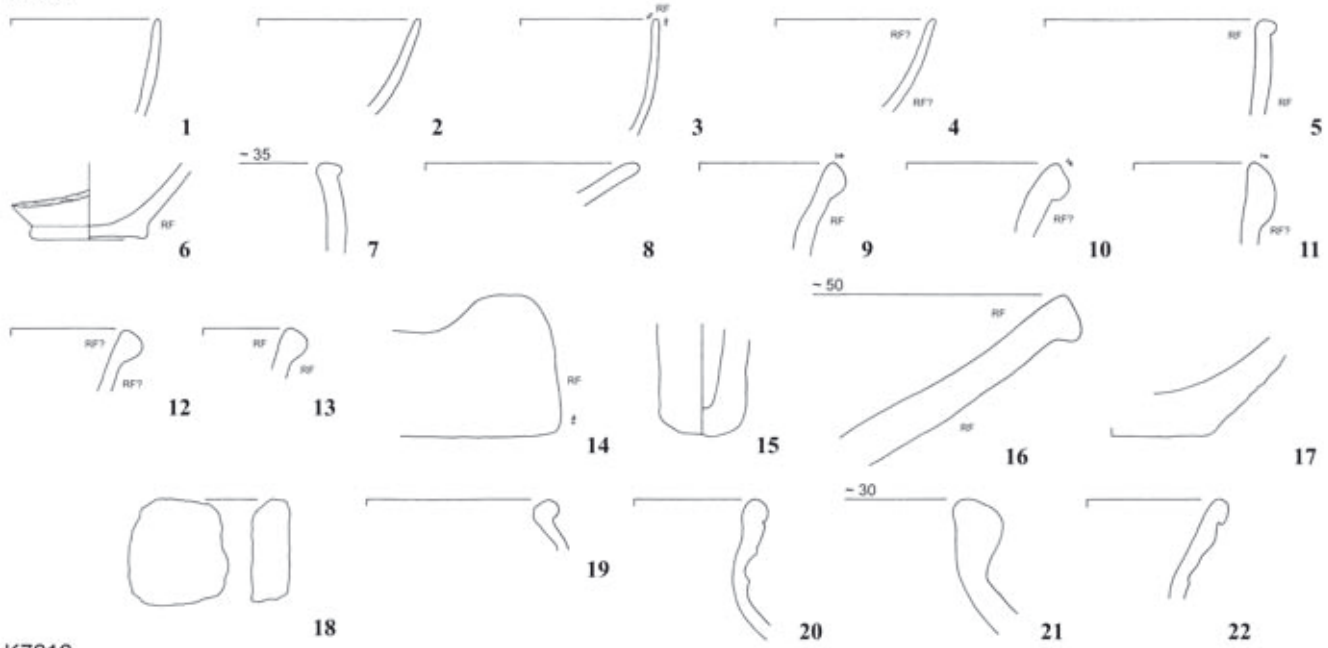

K7616

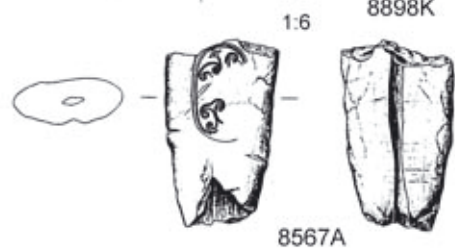
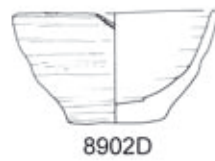
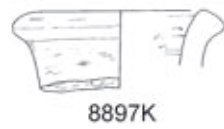
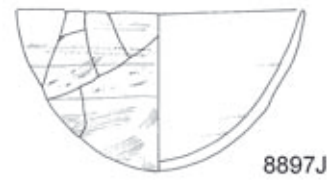
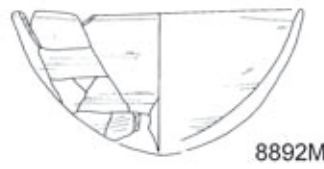
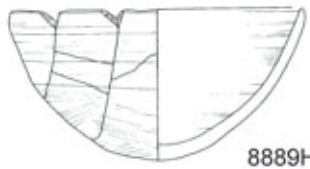
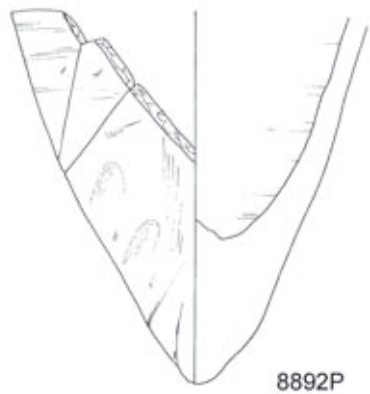
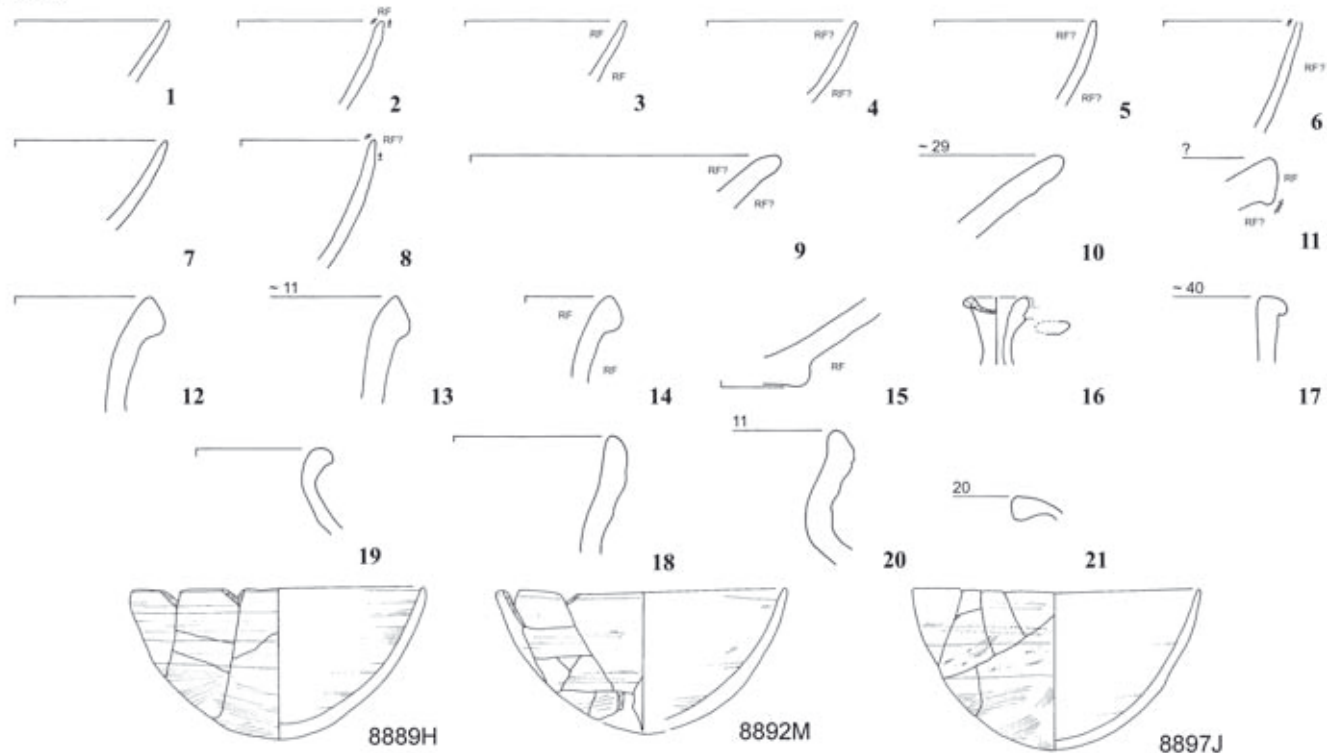

L78 (5)

K7666

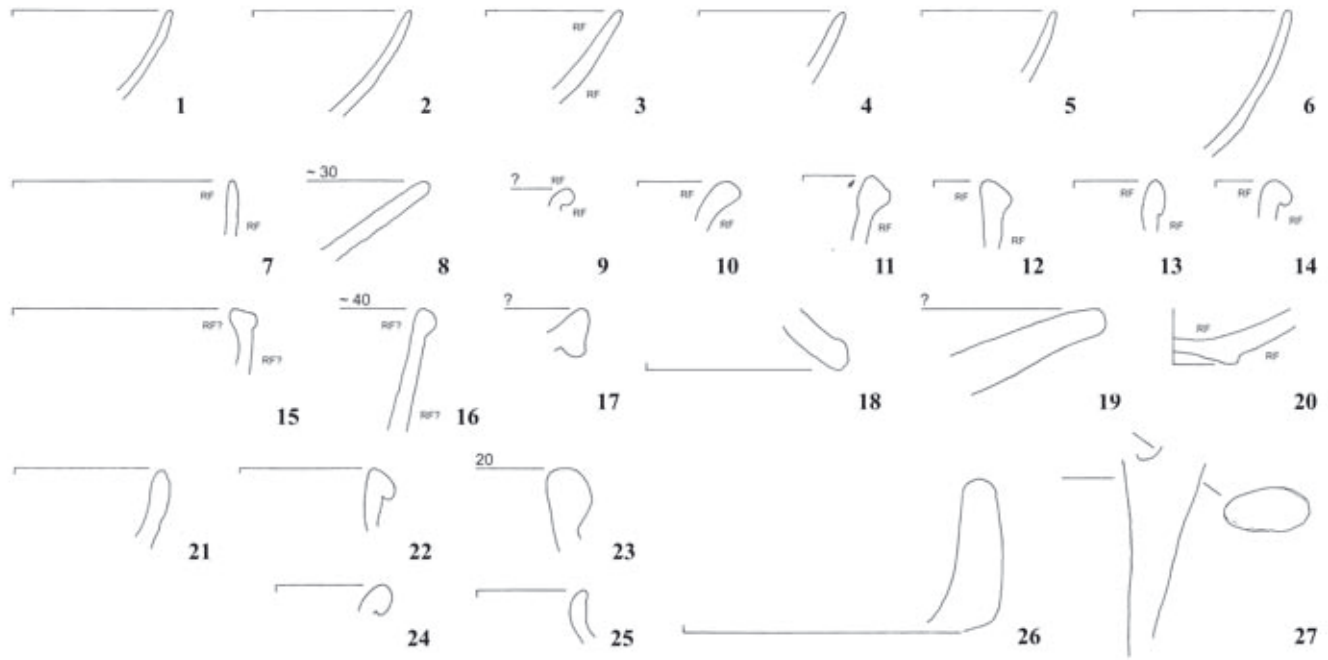

K7667

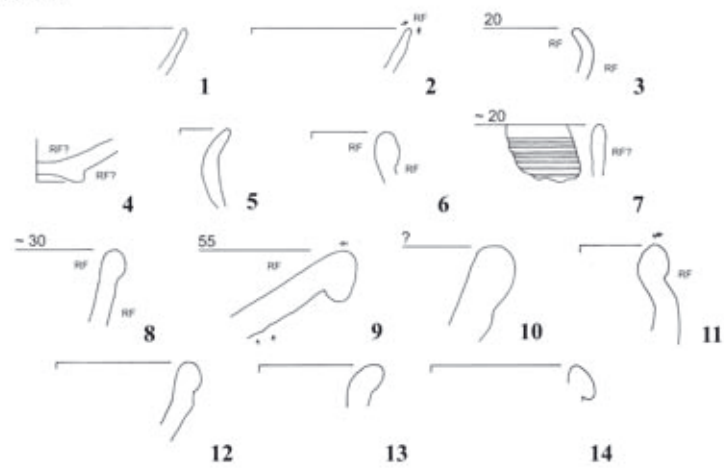

L79



K7665

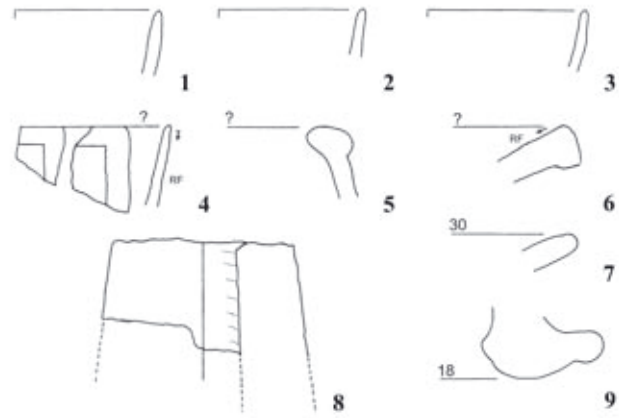

K8127

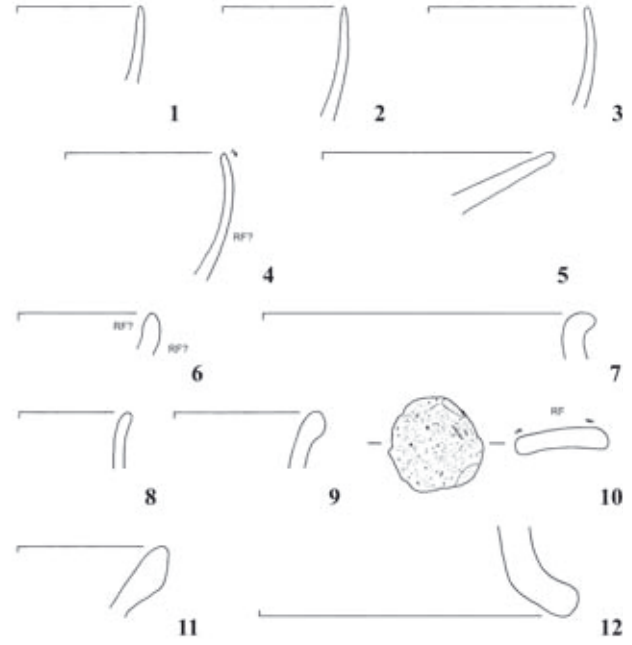

K7683

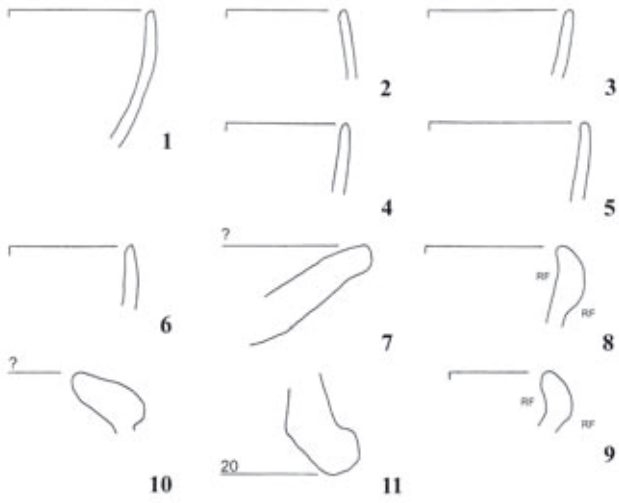

8558B

L80

K8429

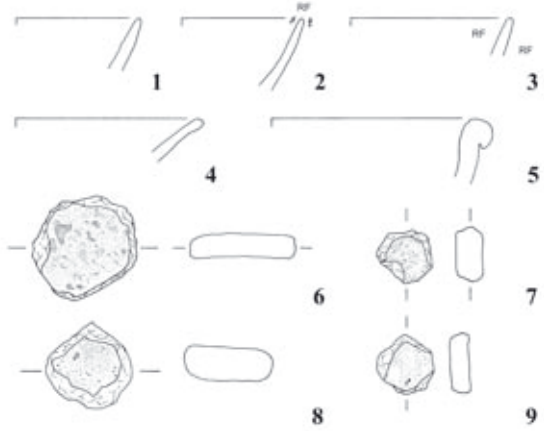

8974D



8974F



8974G



8974E

L85

K7385

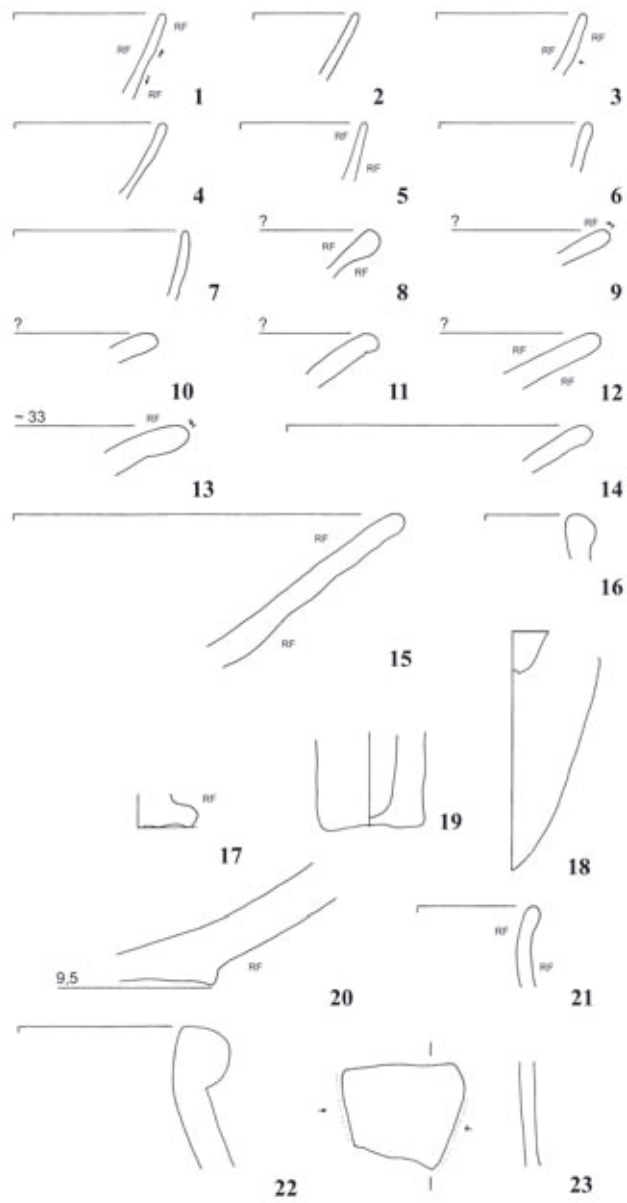

8610



8610



8617V

K8145

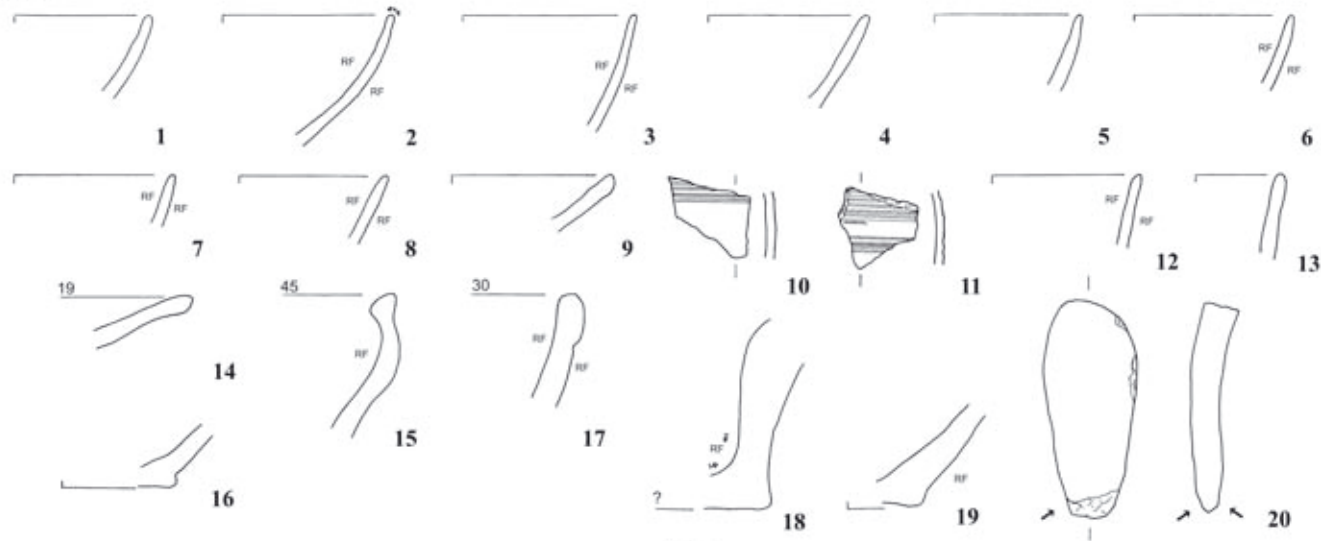

L90

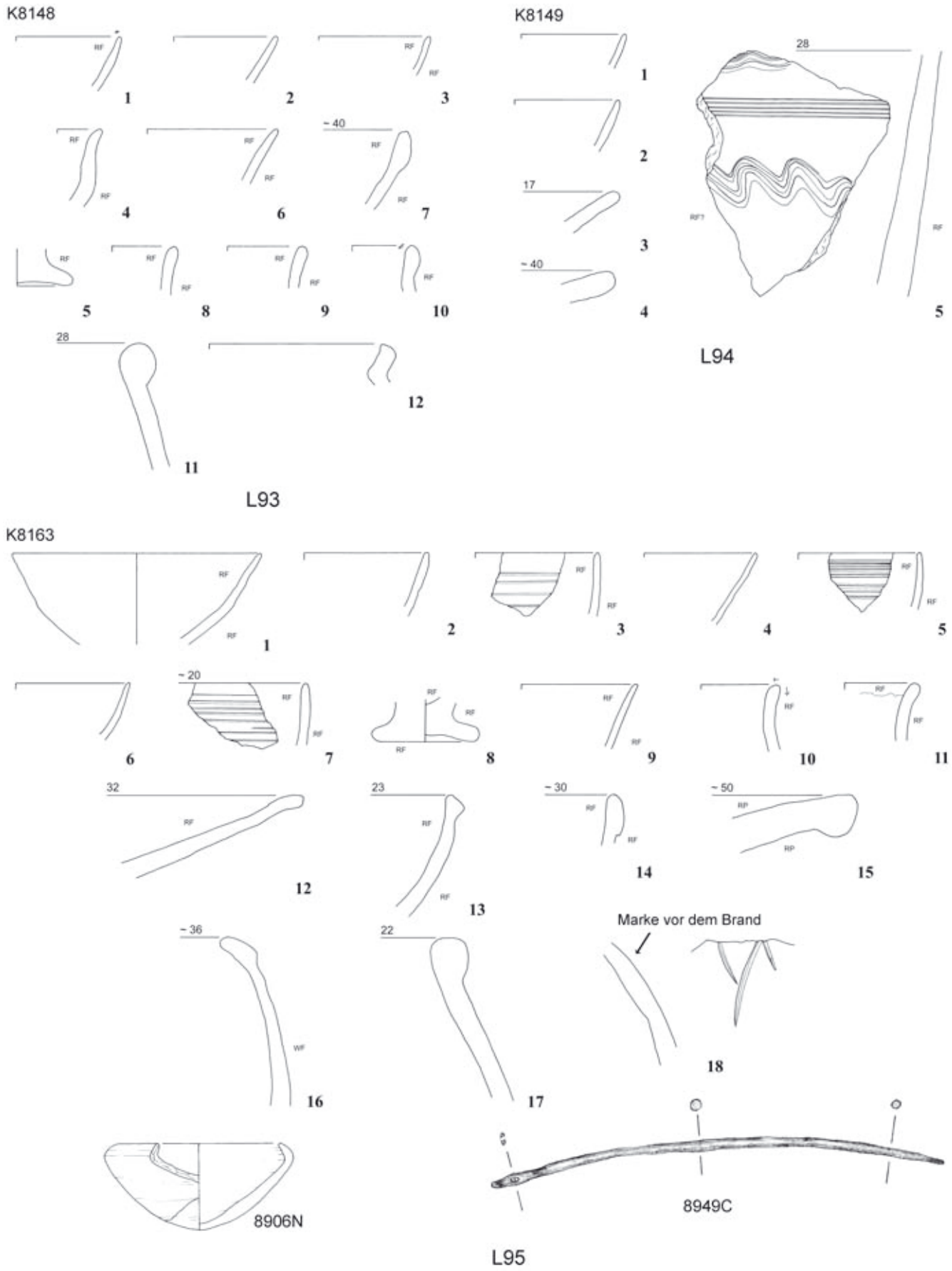

Tafel 41

K7371

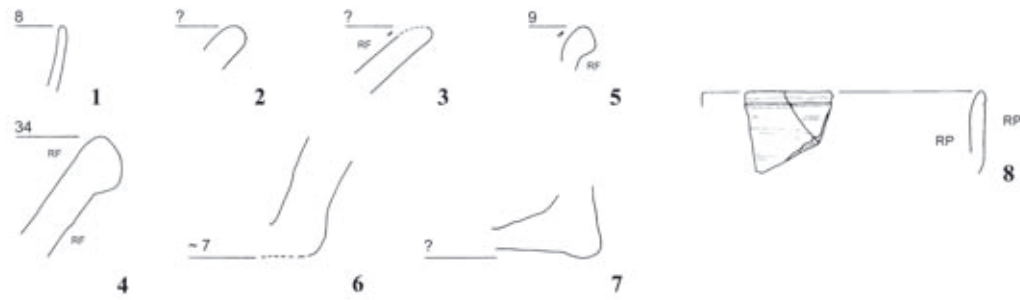

K8147

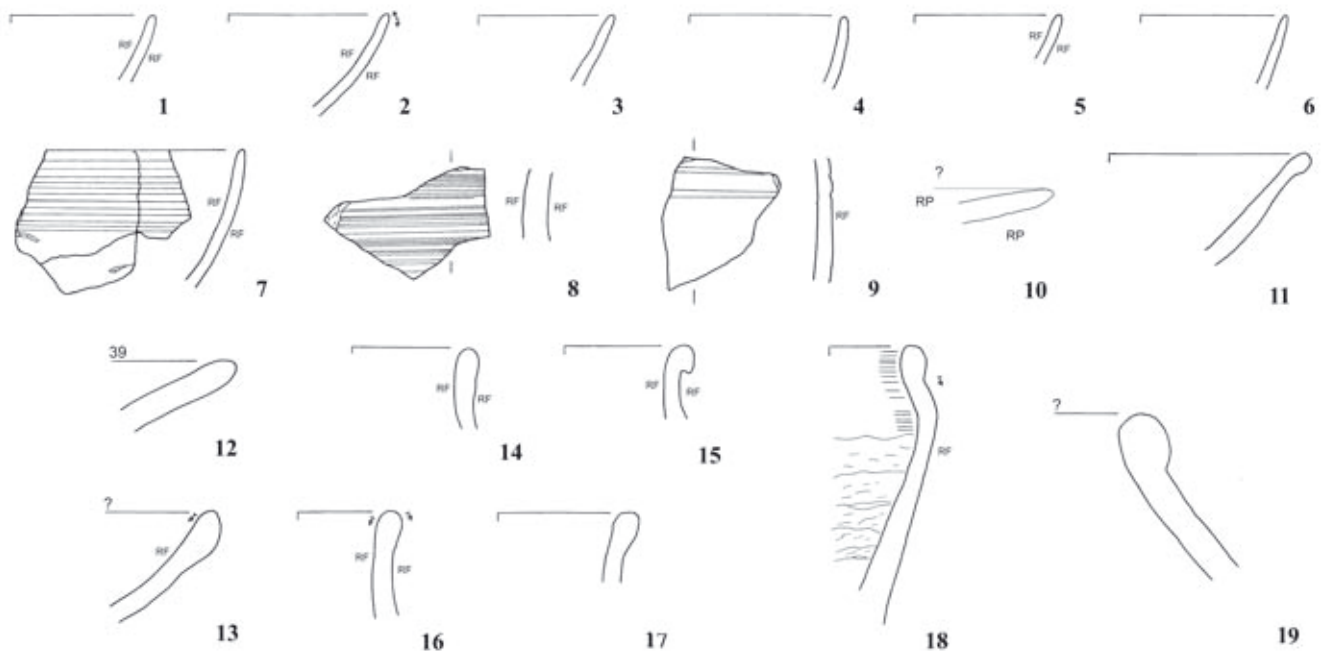

K8430



8974R



8975I



8974S



8976D



8976E  
"RÜCKENFLEISCH"  
(siehe mehr grav)



8975K



8975E



8975J



8976I

L99

K7545

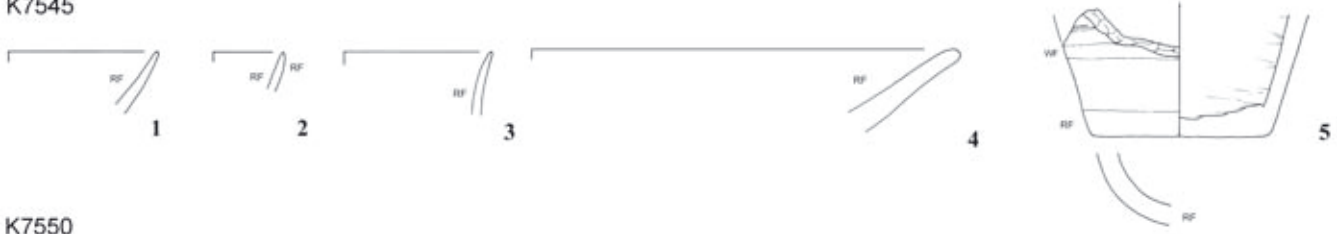

K7550

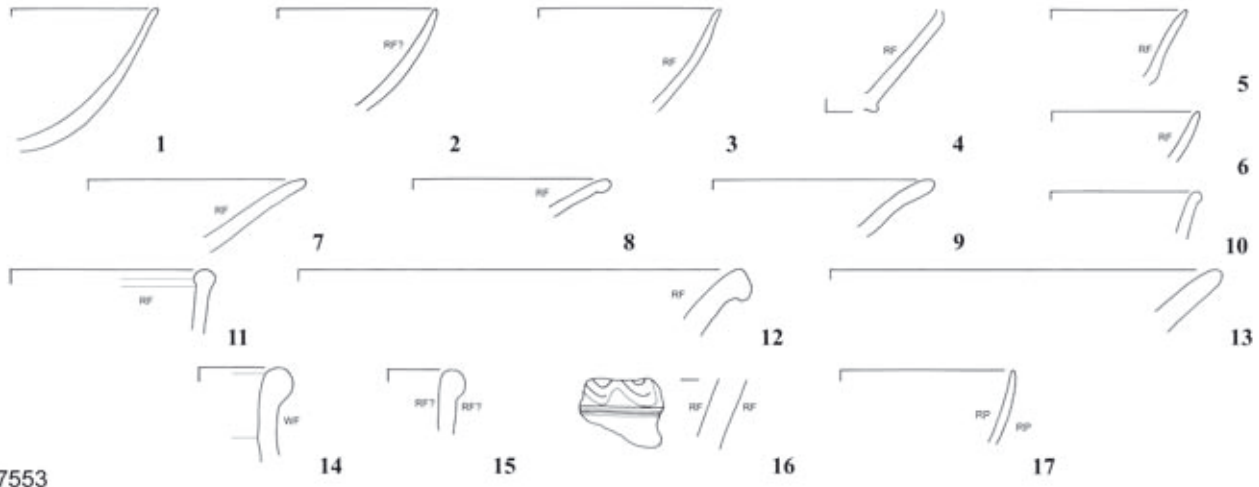

K7553

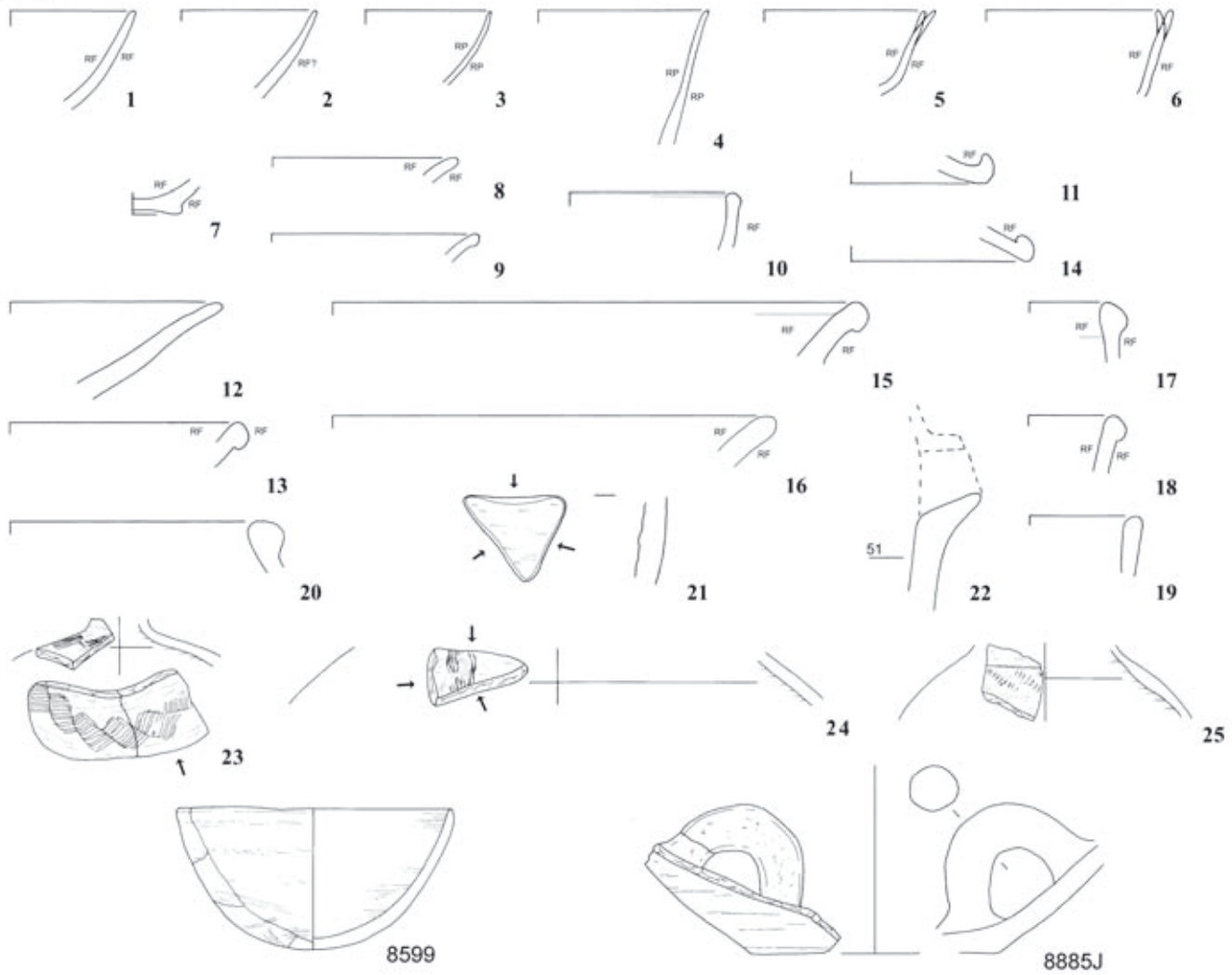

L102

Tafel 43

K7543

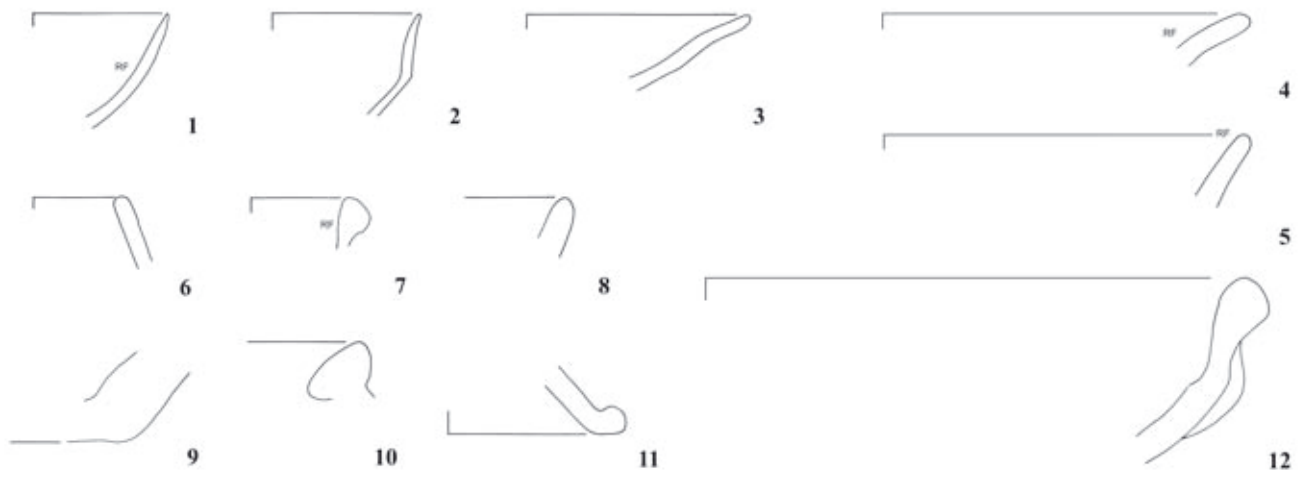

K7548

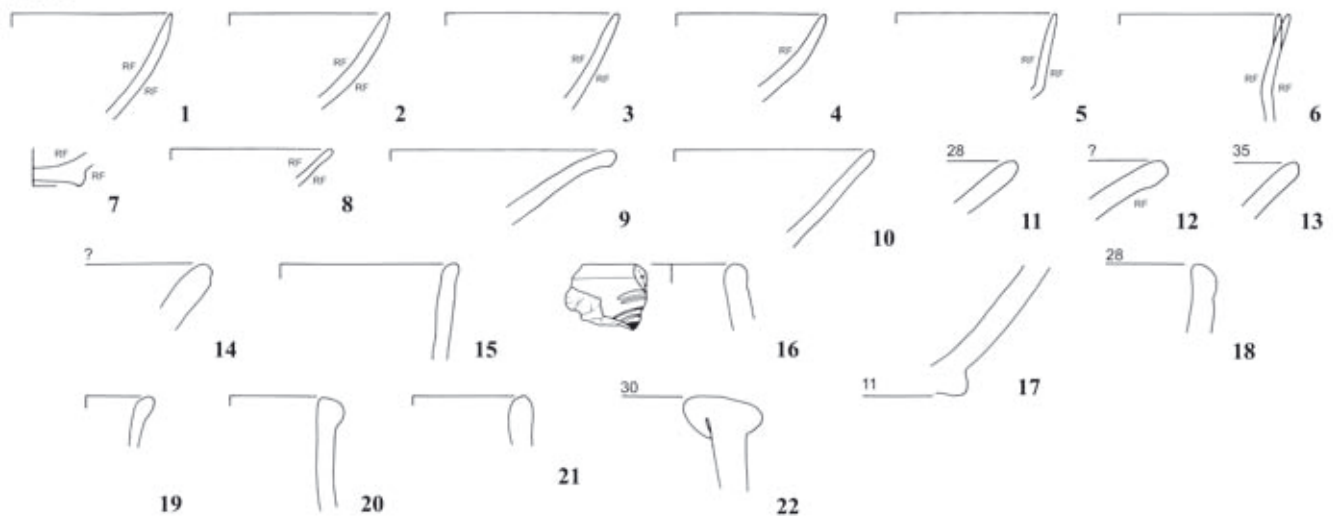

K7551

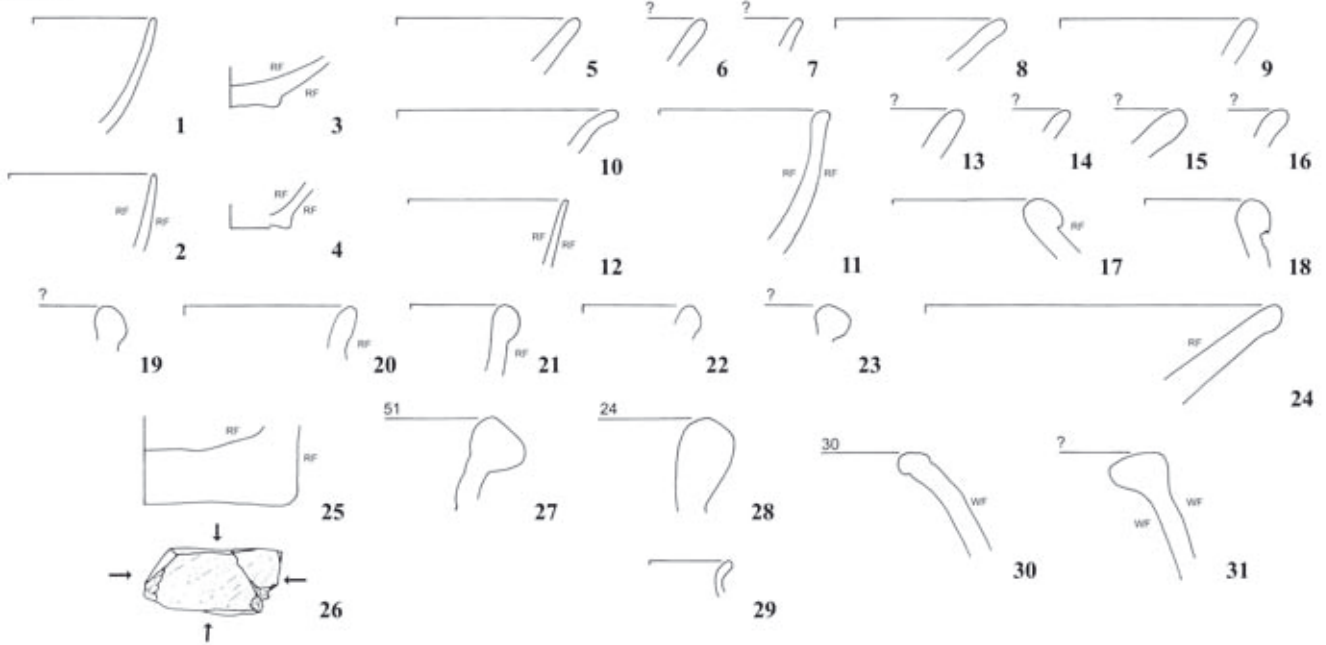

L103 (1)





8559P

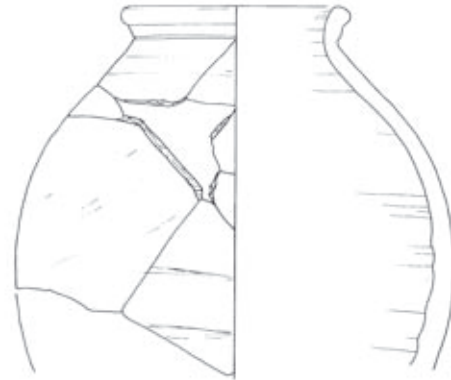

8899H



8620L



8620M



8619C



8618B

L103 (2)

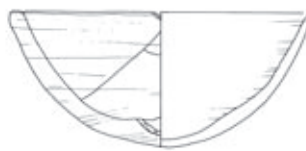

8899X

L104

K7544

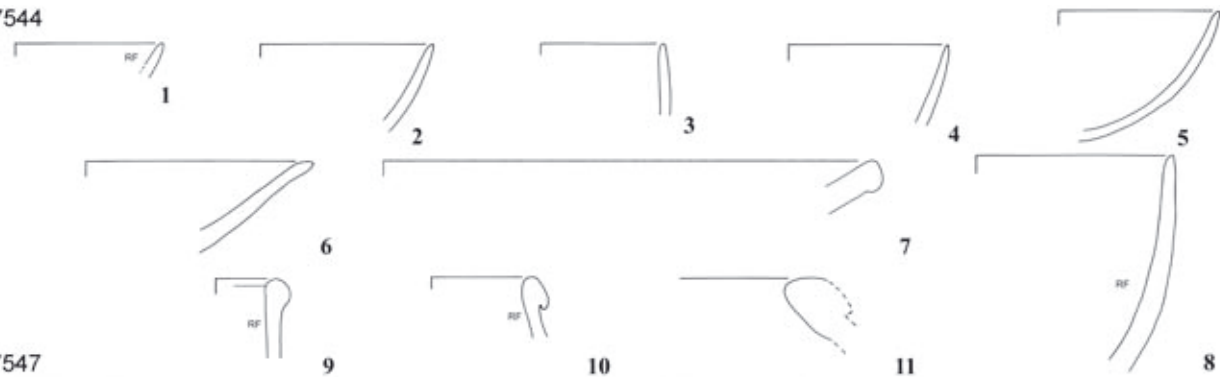

K7547

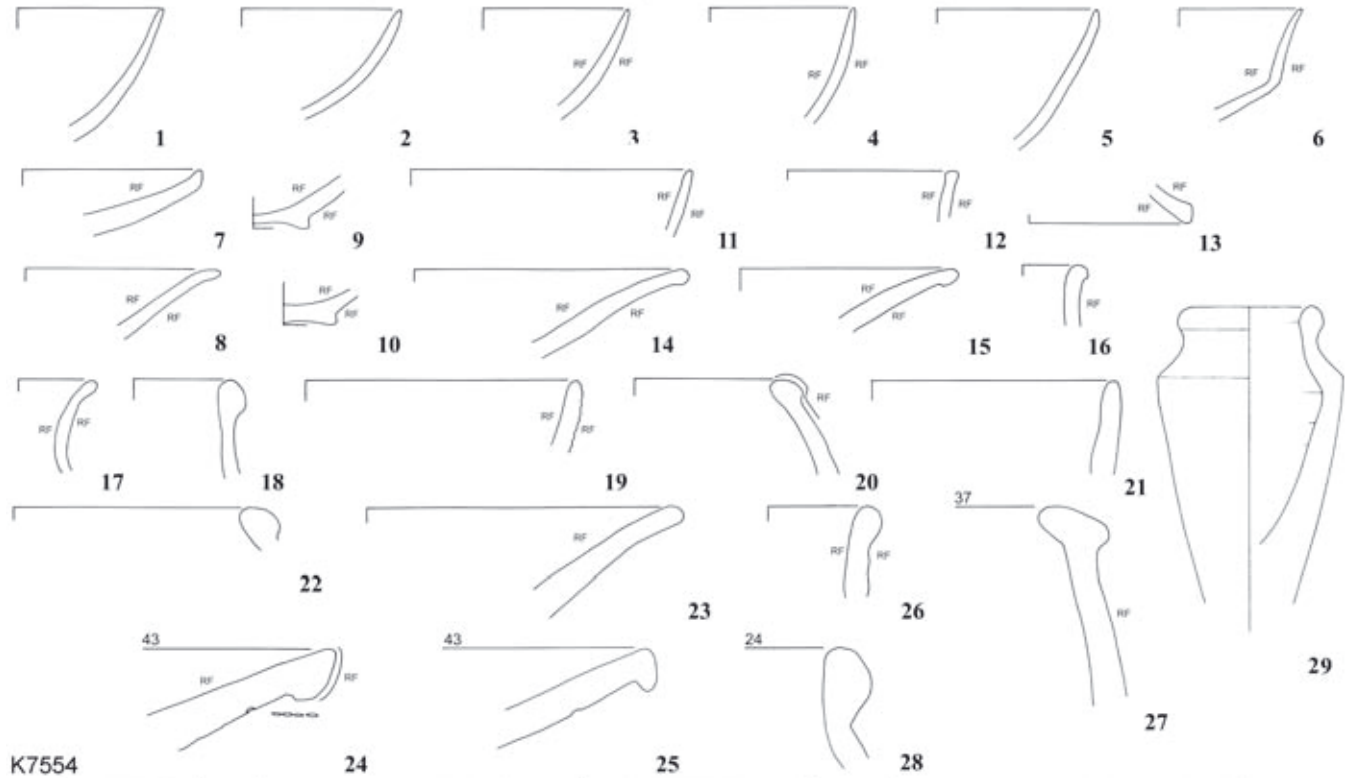

K7554

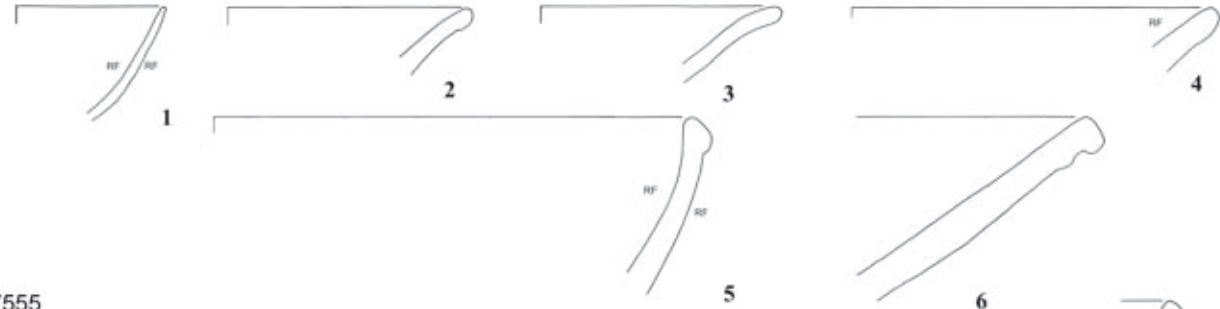

K7555

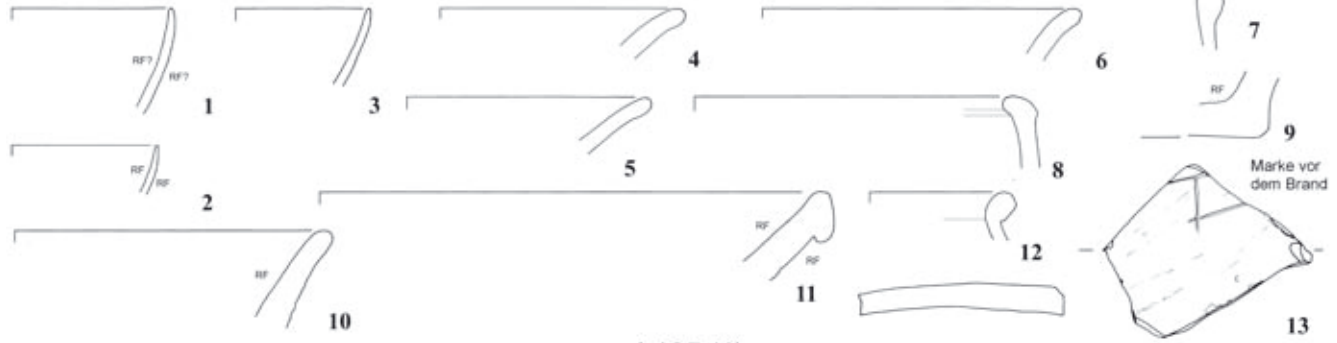

L105 (1)

Tafel 46



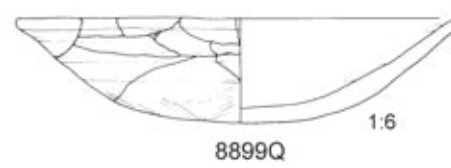
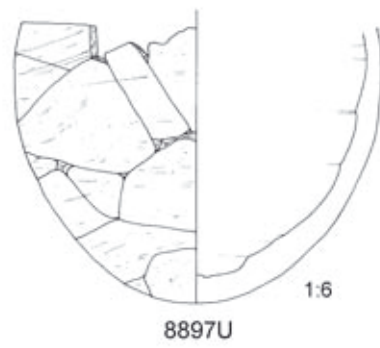
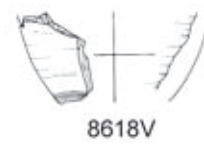
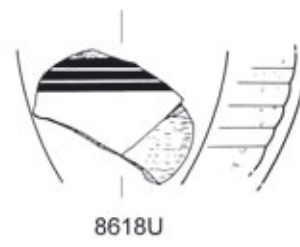
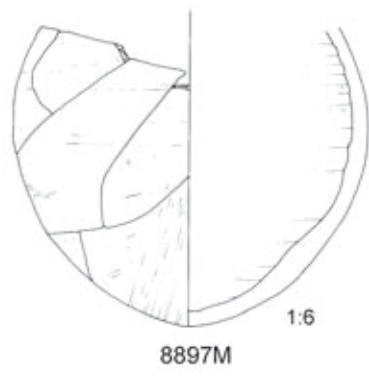
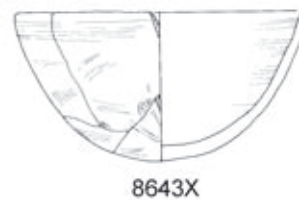
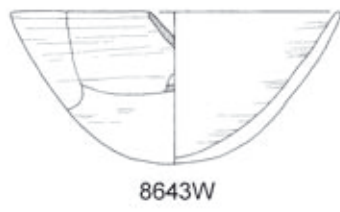
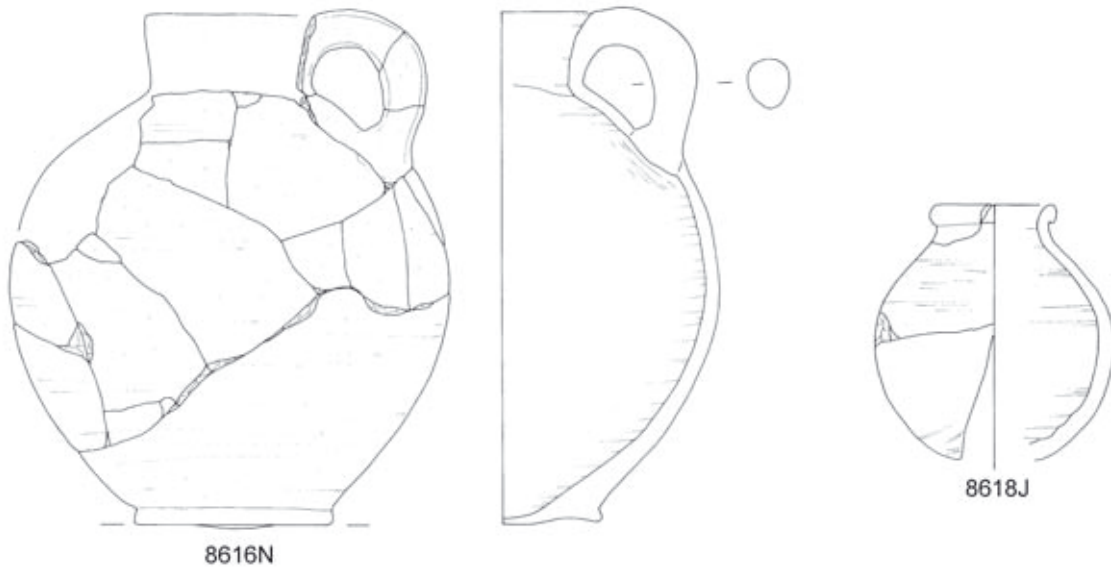

L105 (2)

K7546

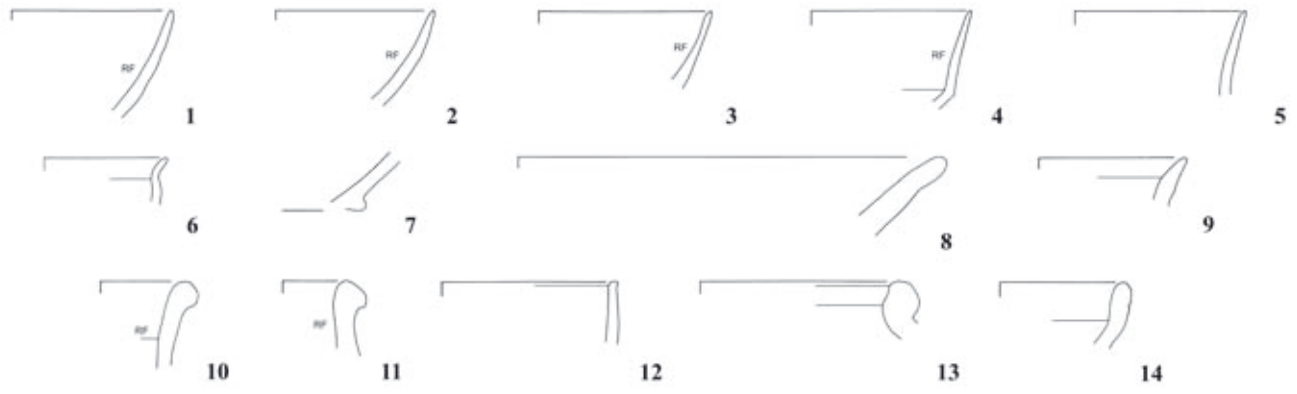

K7812

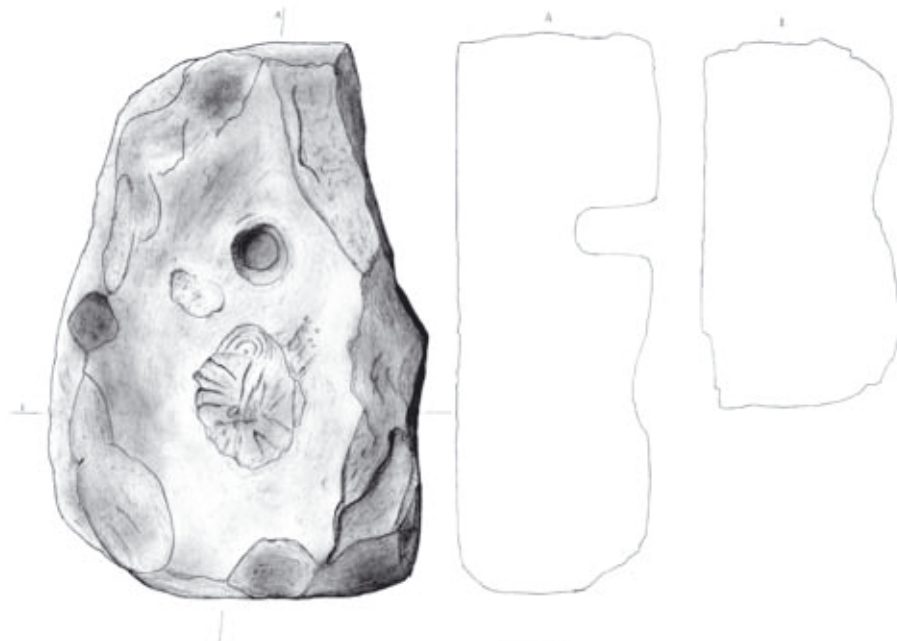
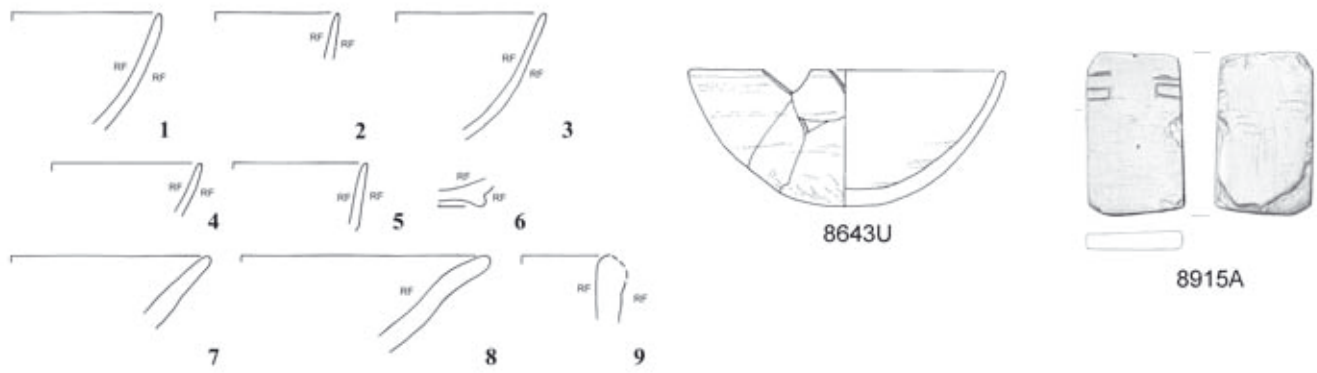

8973S

L106

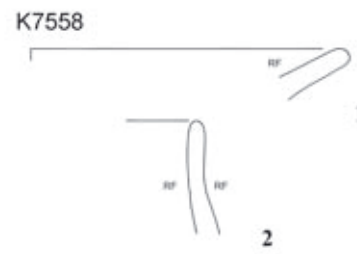
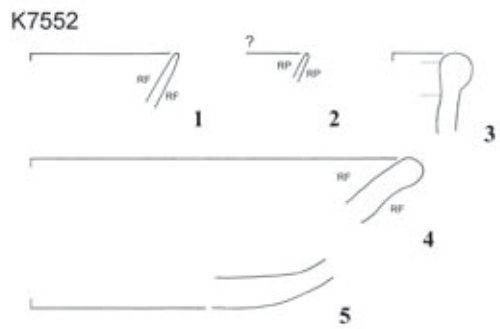

8579

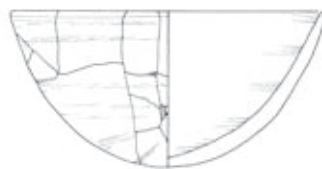

8580



8581



8582

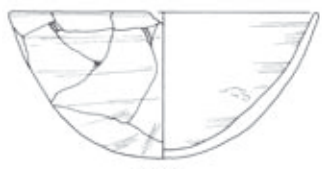

8583



8585

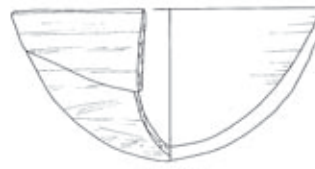

8885G



8888Q

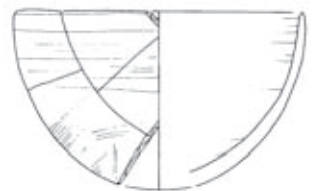

8888X



8892L

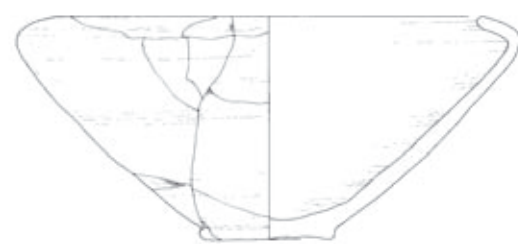

8584

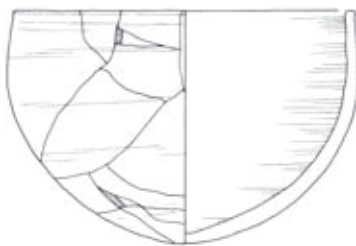

8586



8643F



8897I



8885F



8885K



8897T

L107

Tafel 49

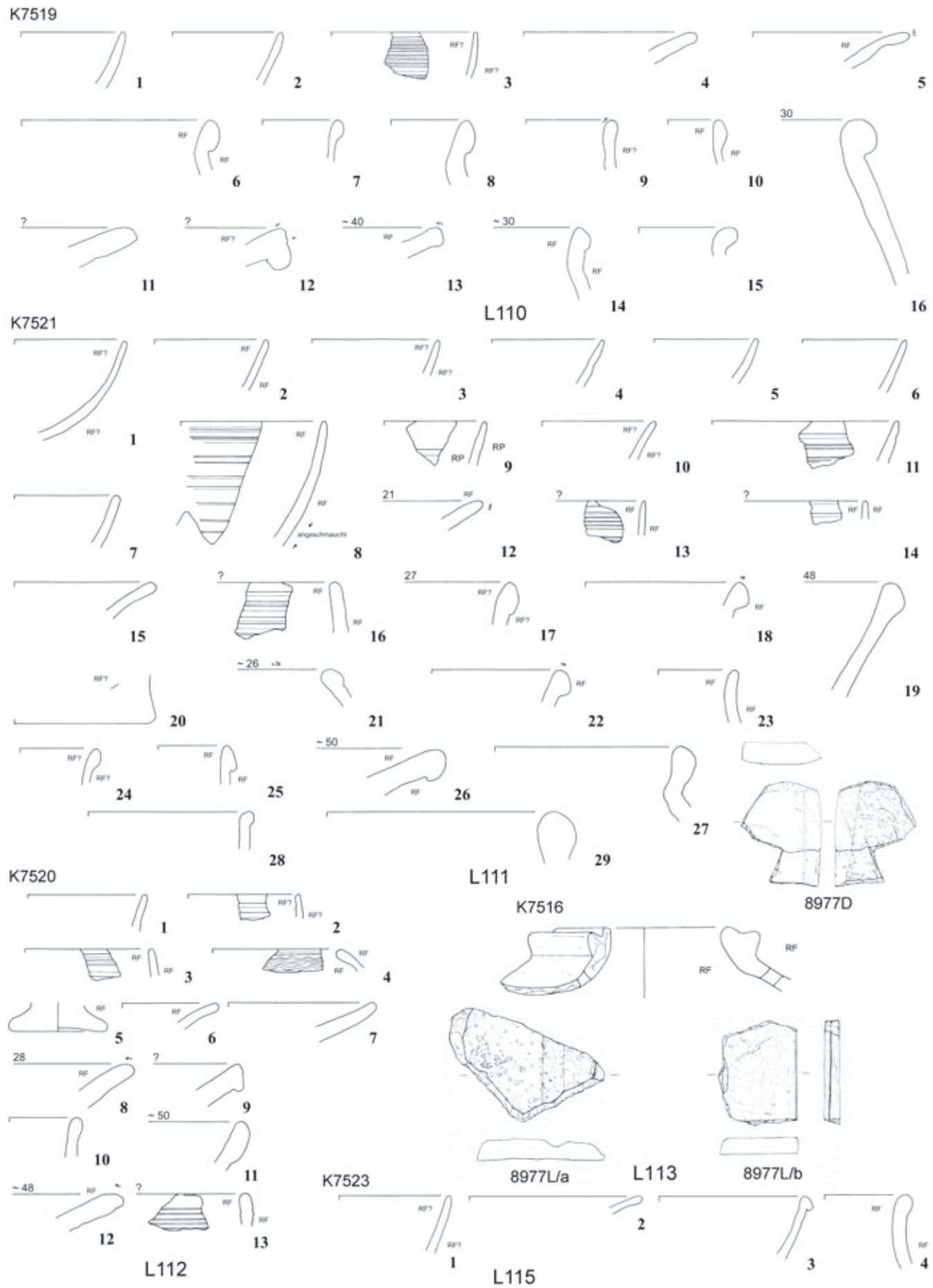

K7370



K7373

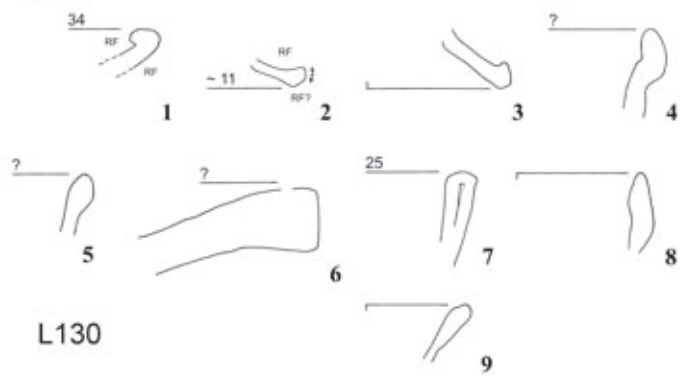

L130

K7374

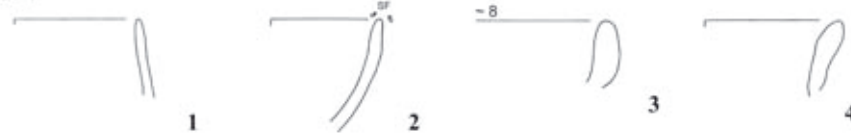

L132

K7675

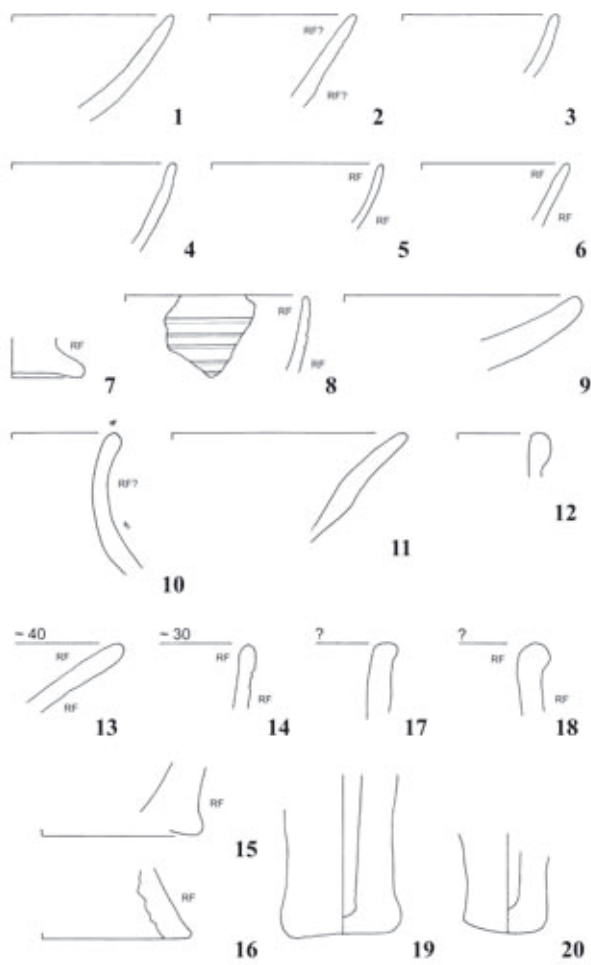

K7679

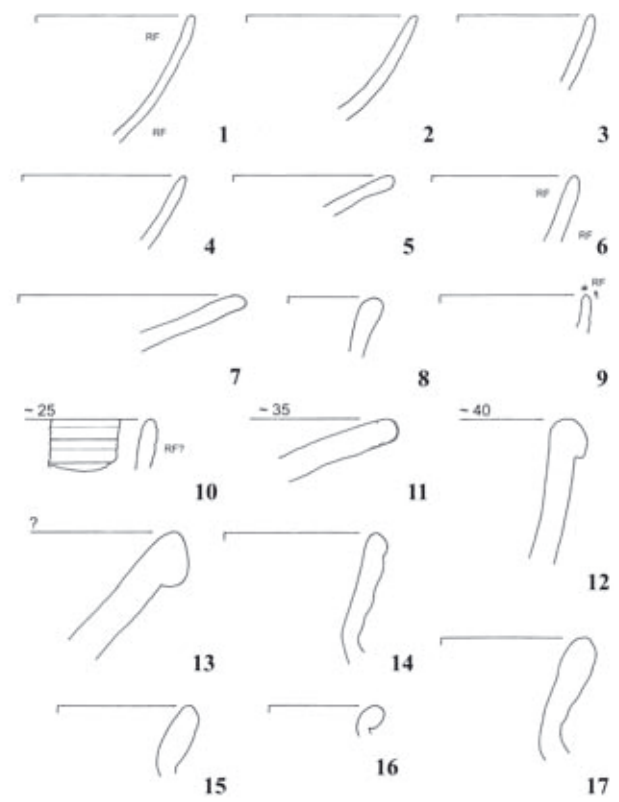

L136



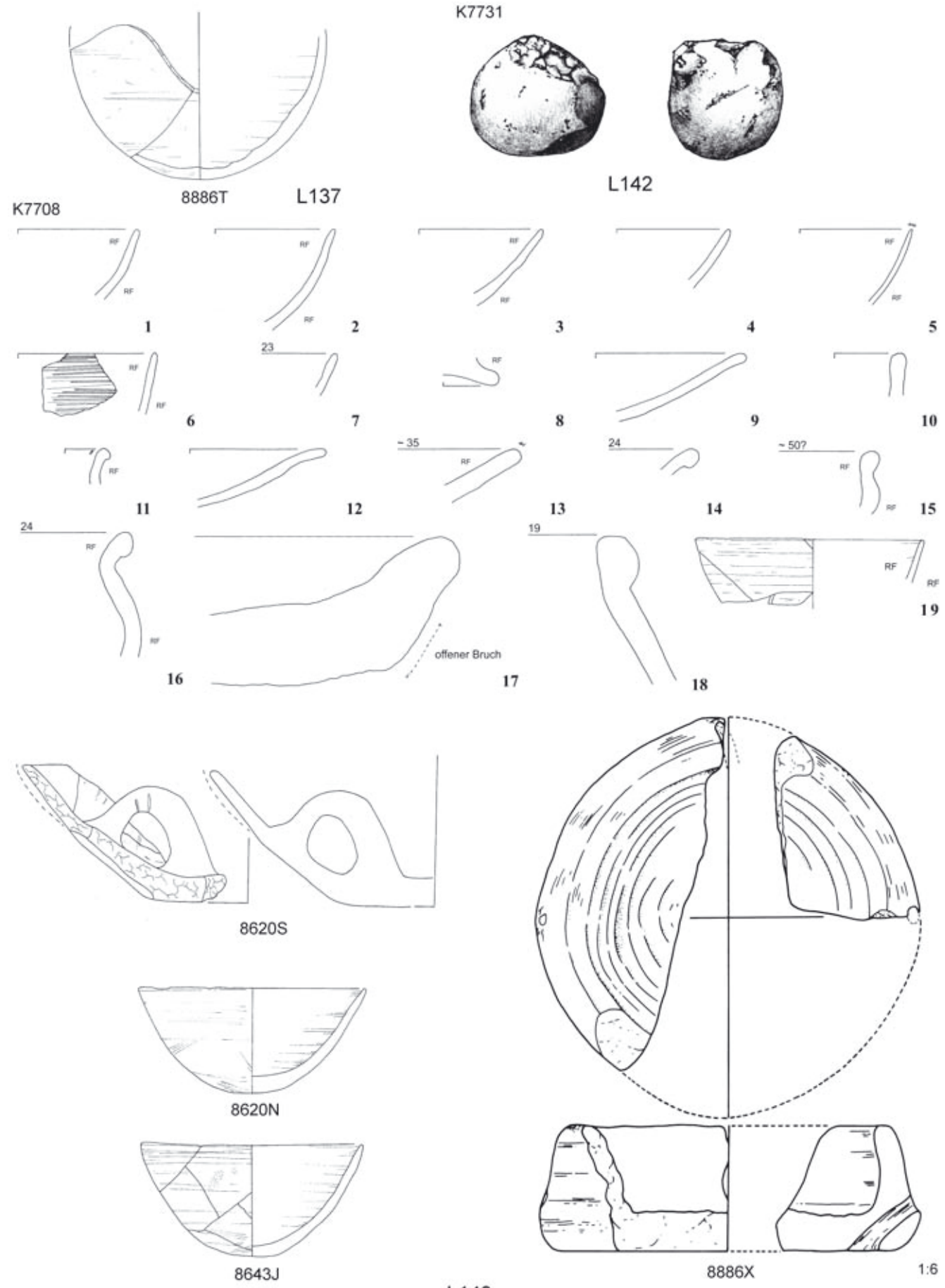

L143

Tafel 52

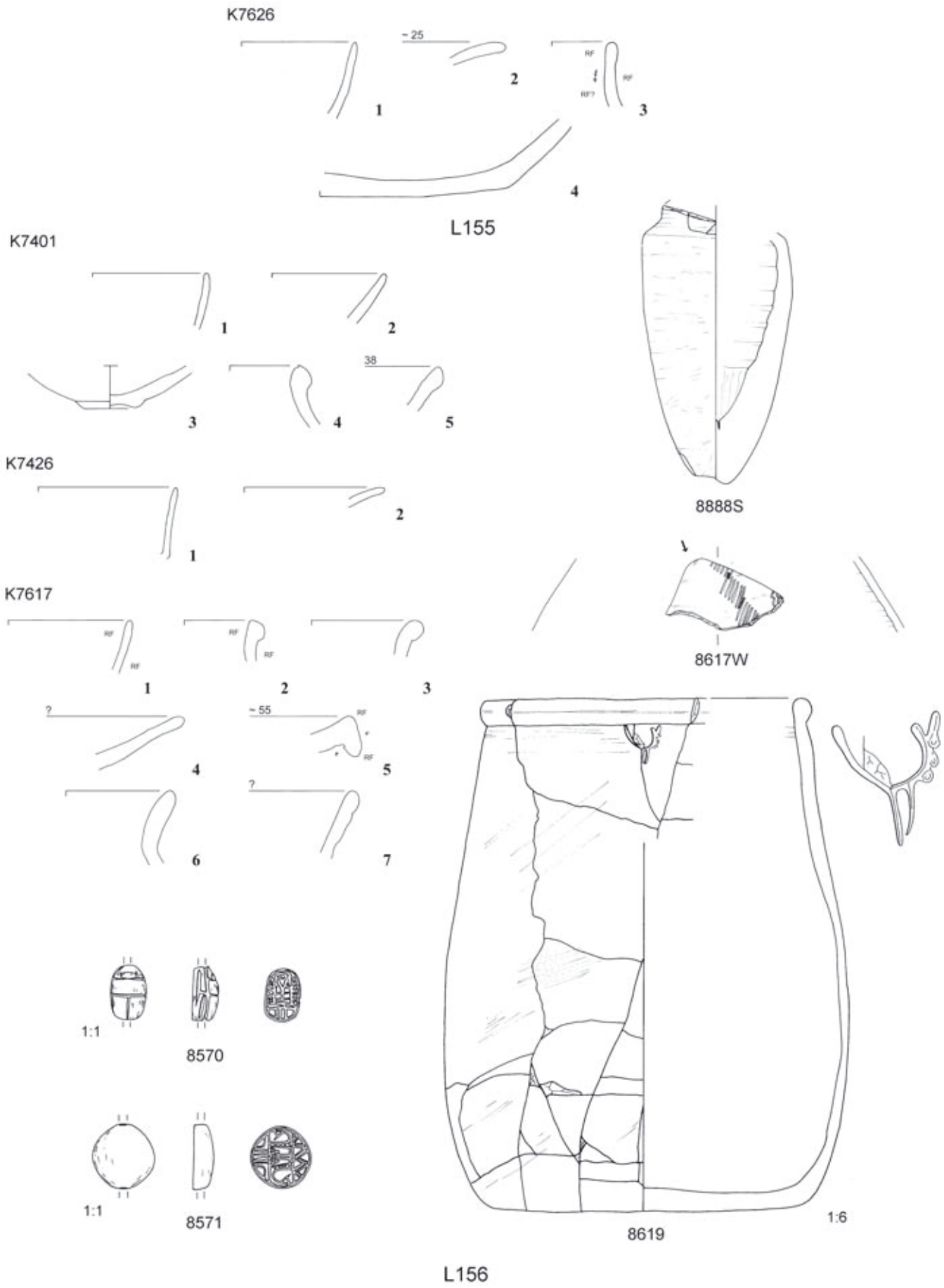

L156

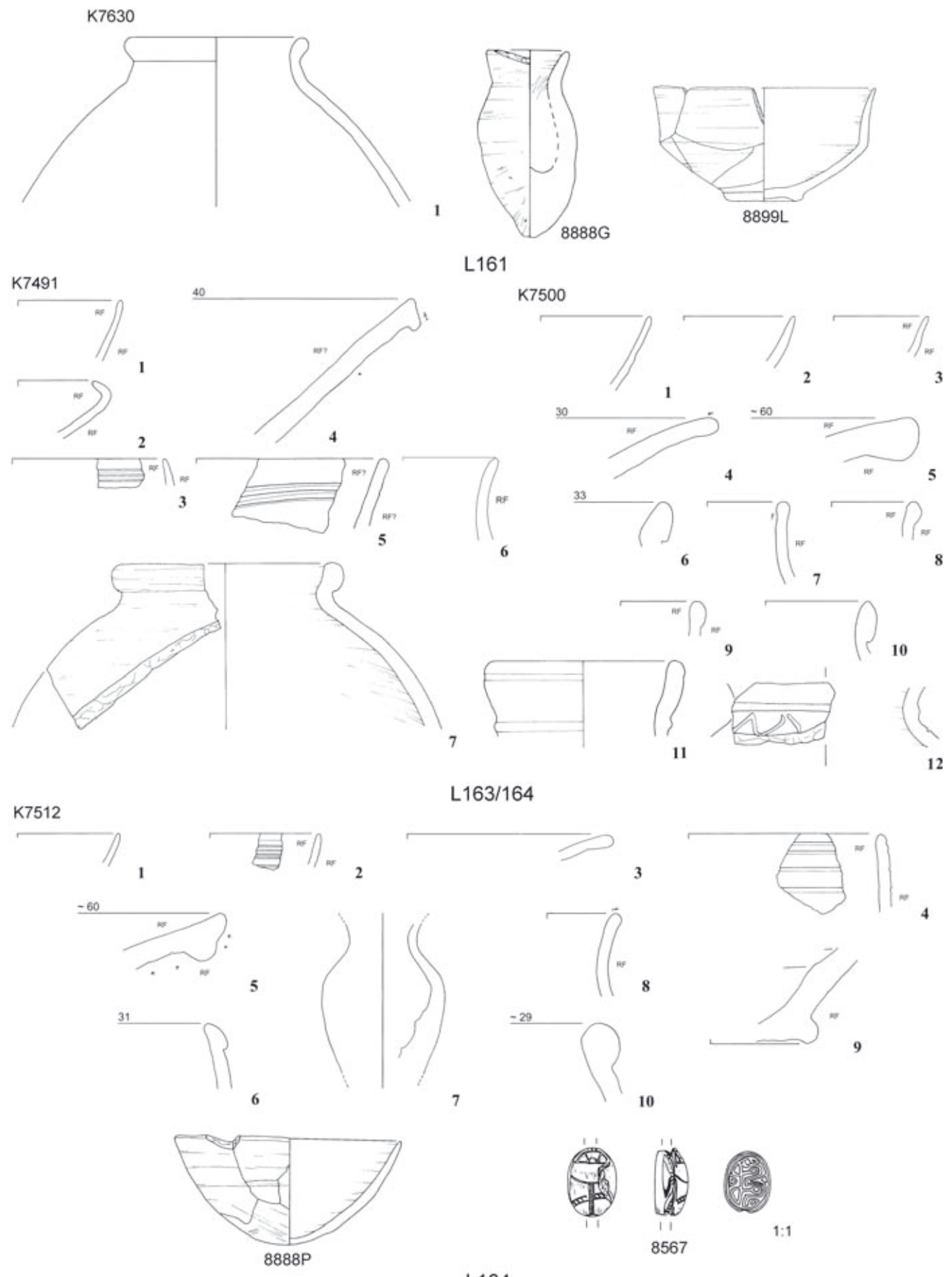



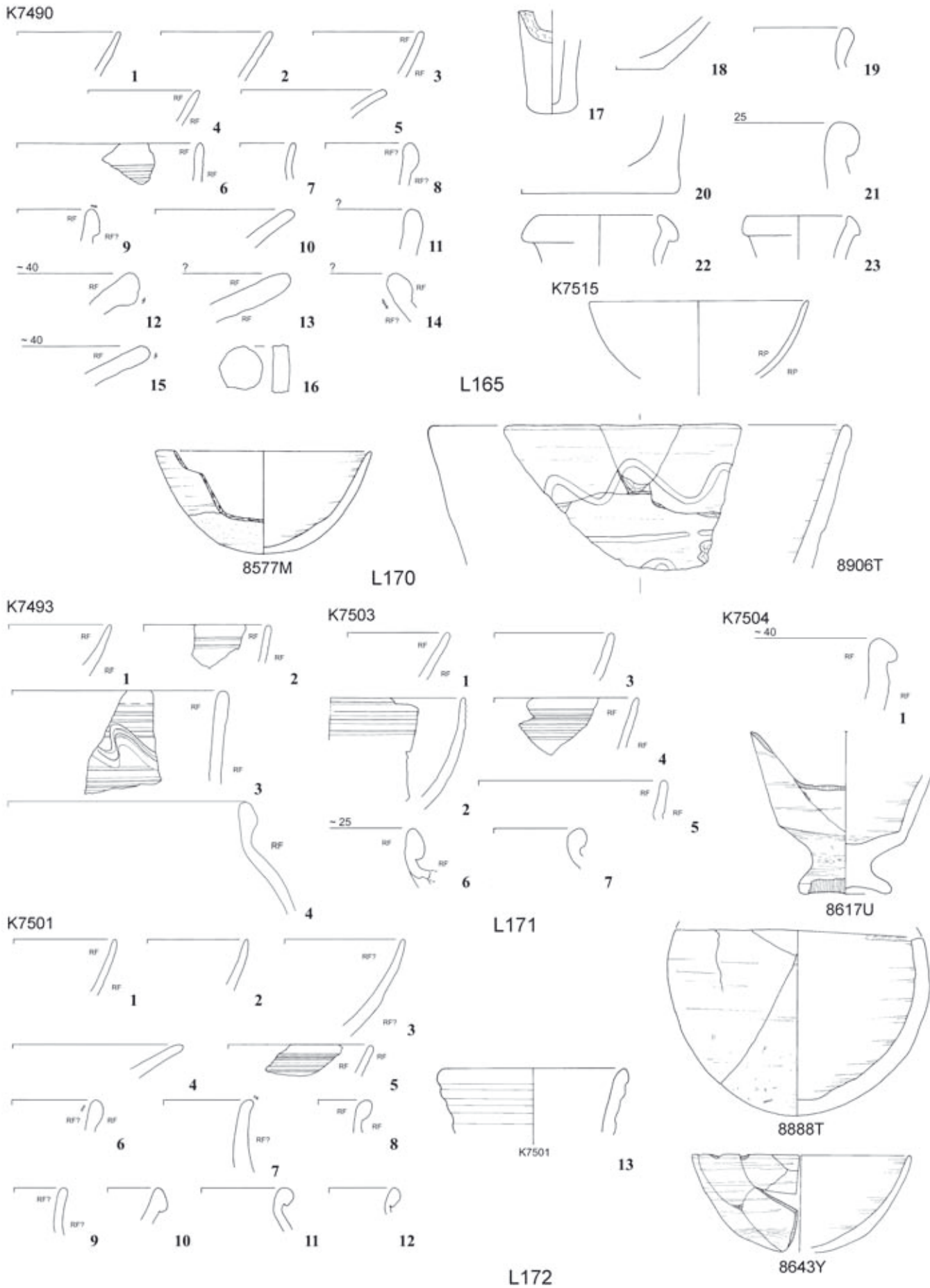



K7474

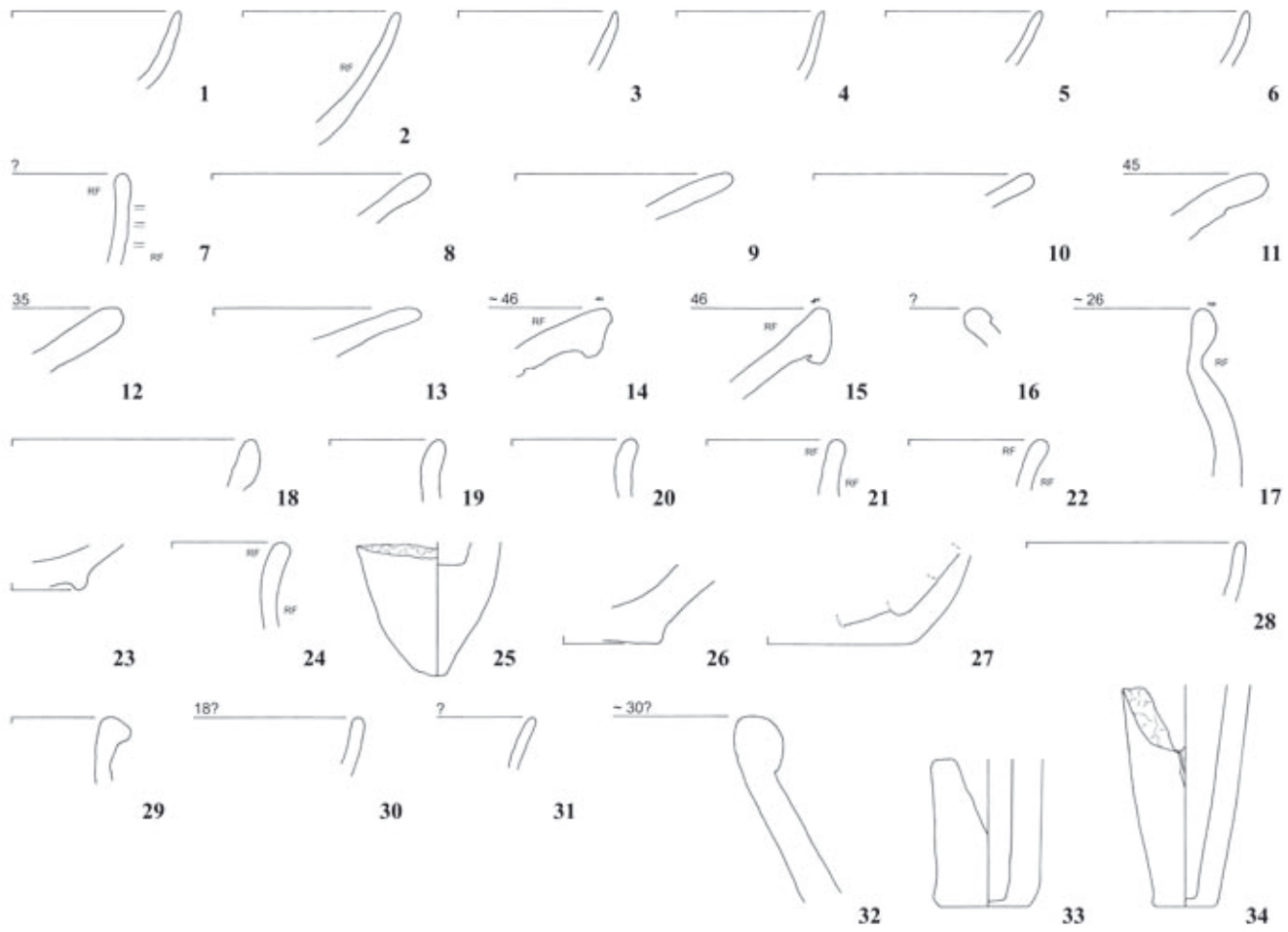

K7488

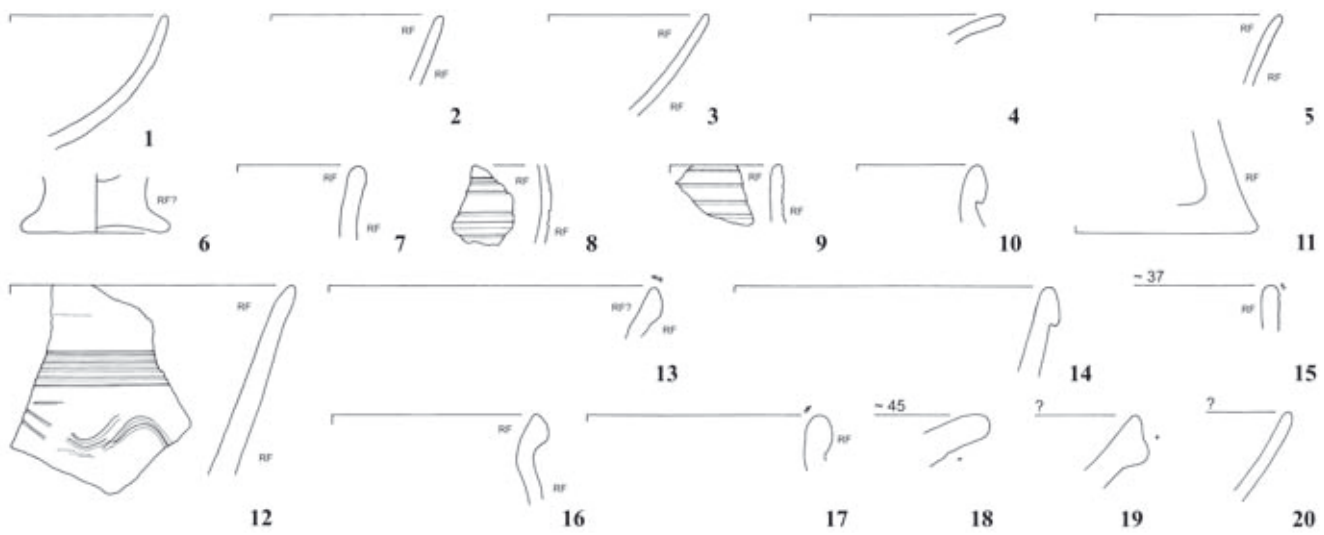

L176 (1)

K7489

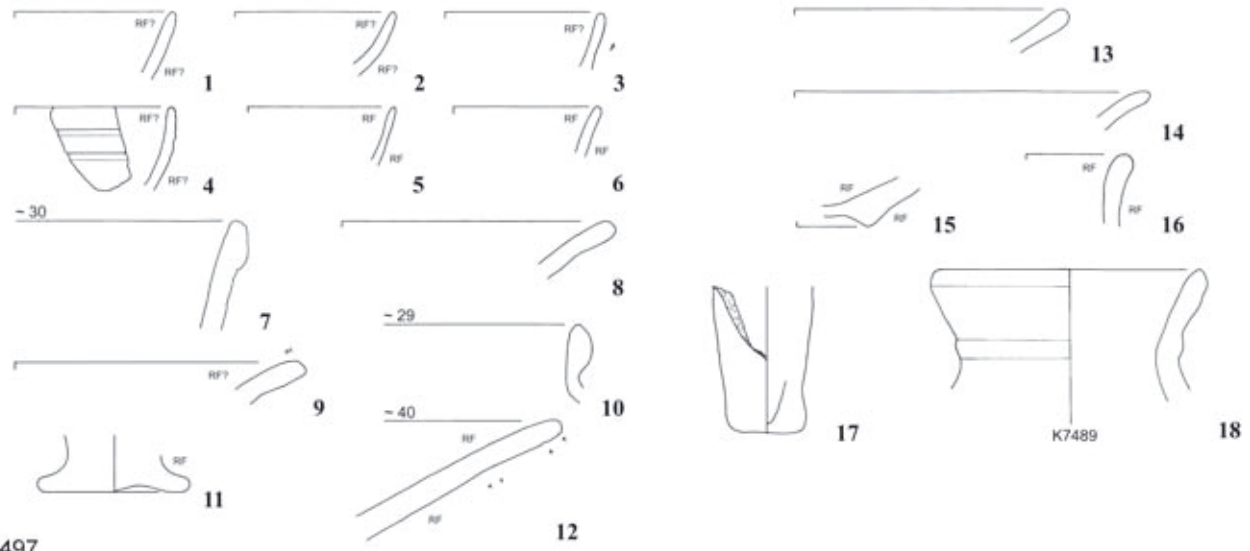

K7497

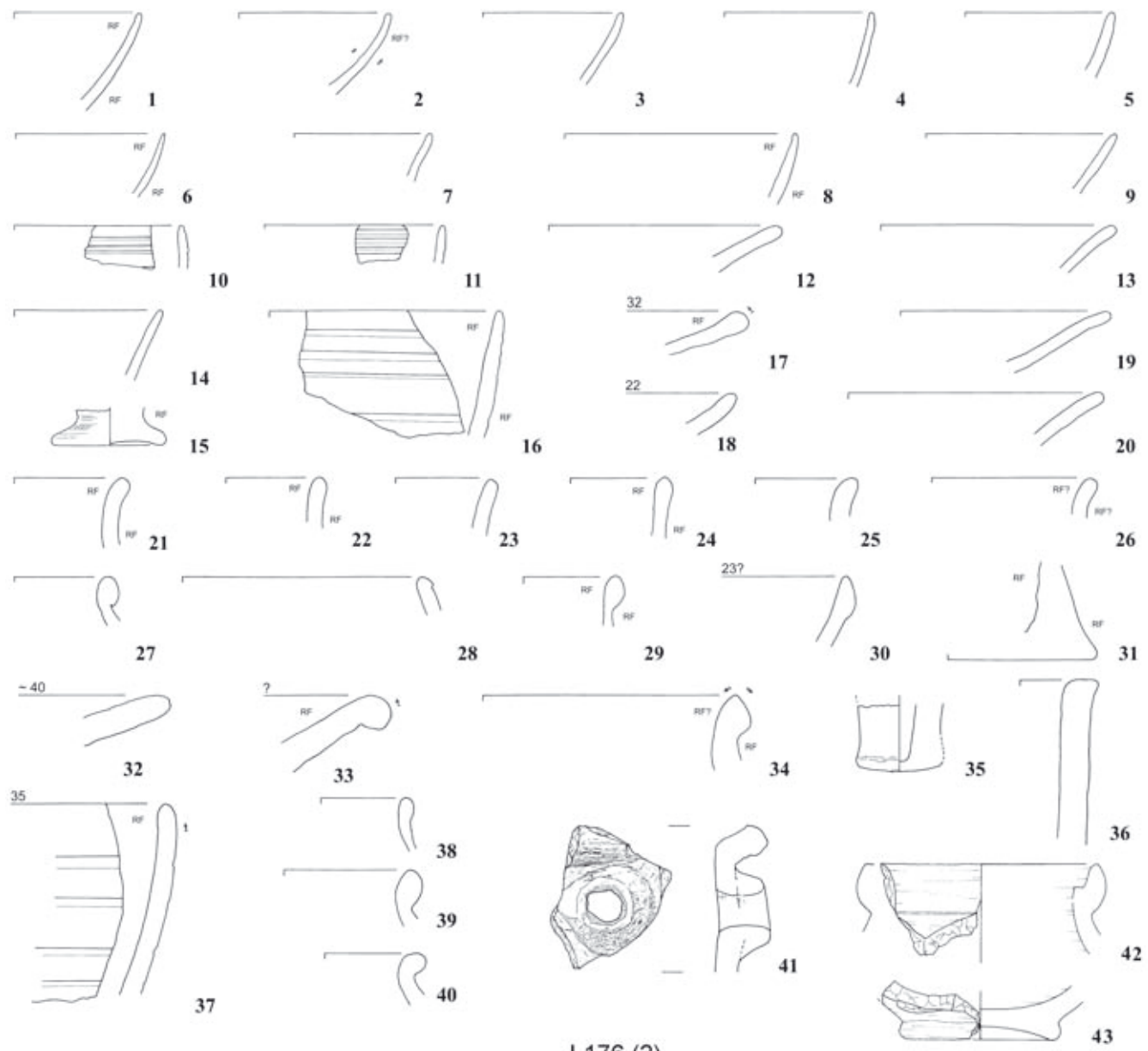

L176 (2)

K7498

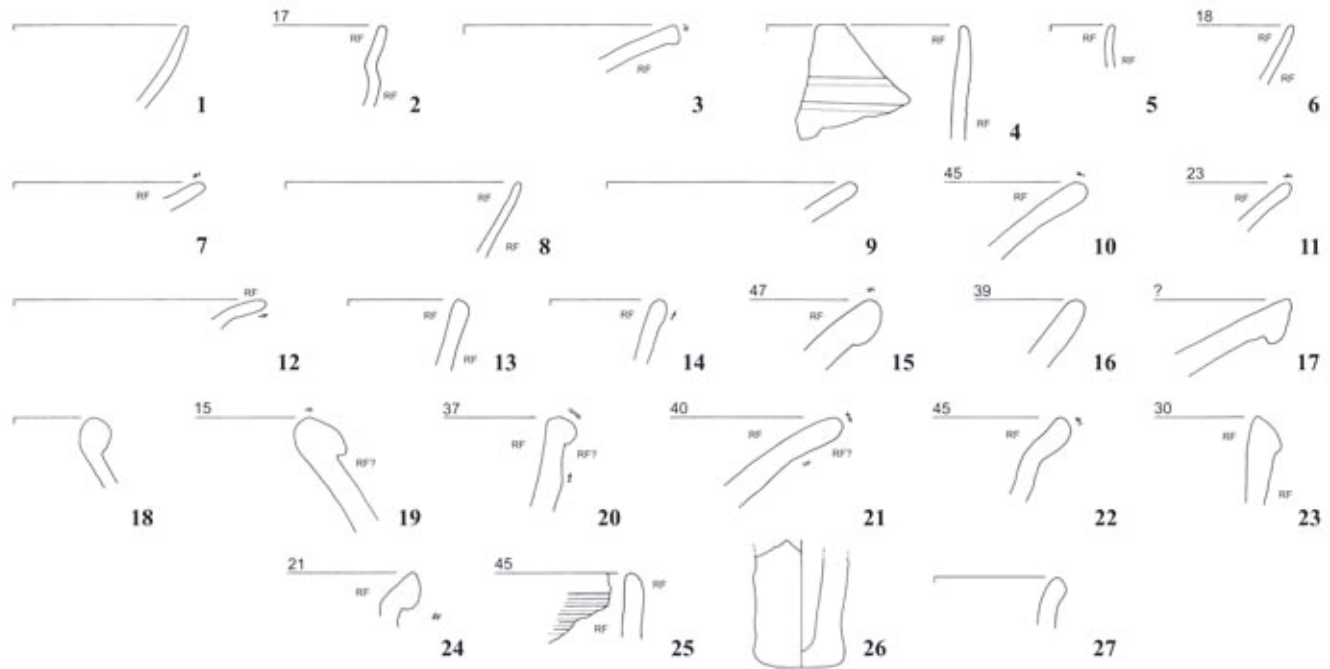

K7499

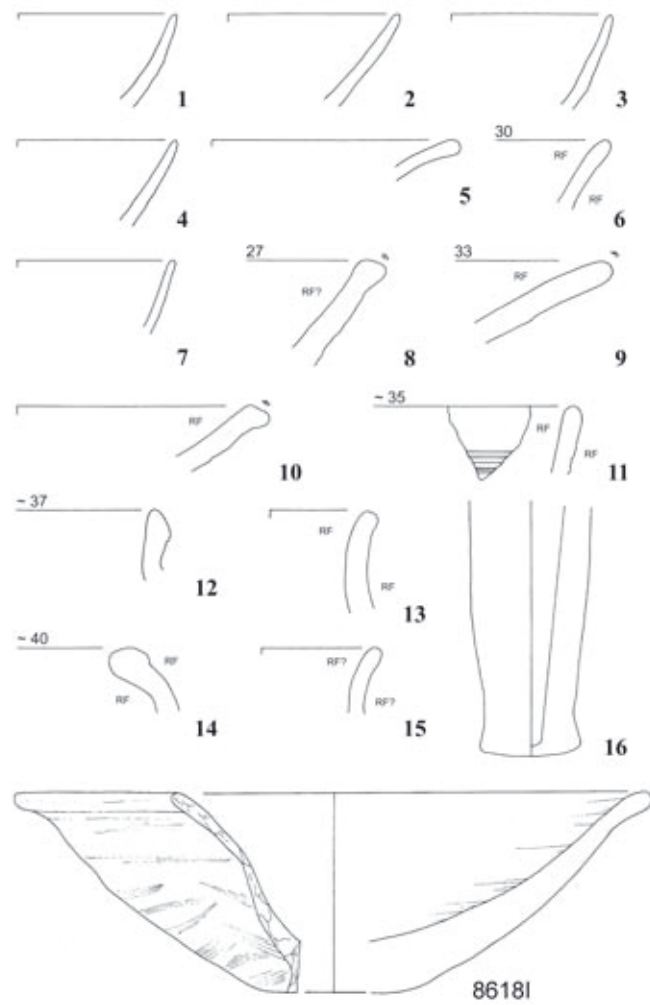

L176 (3)

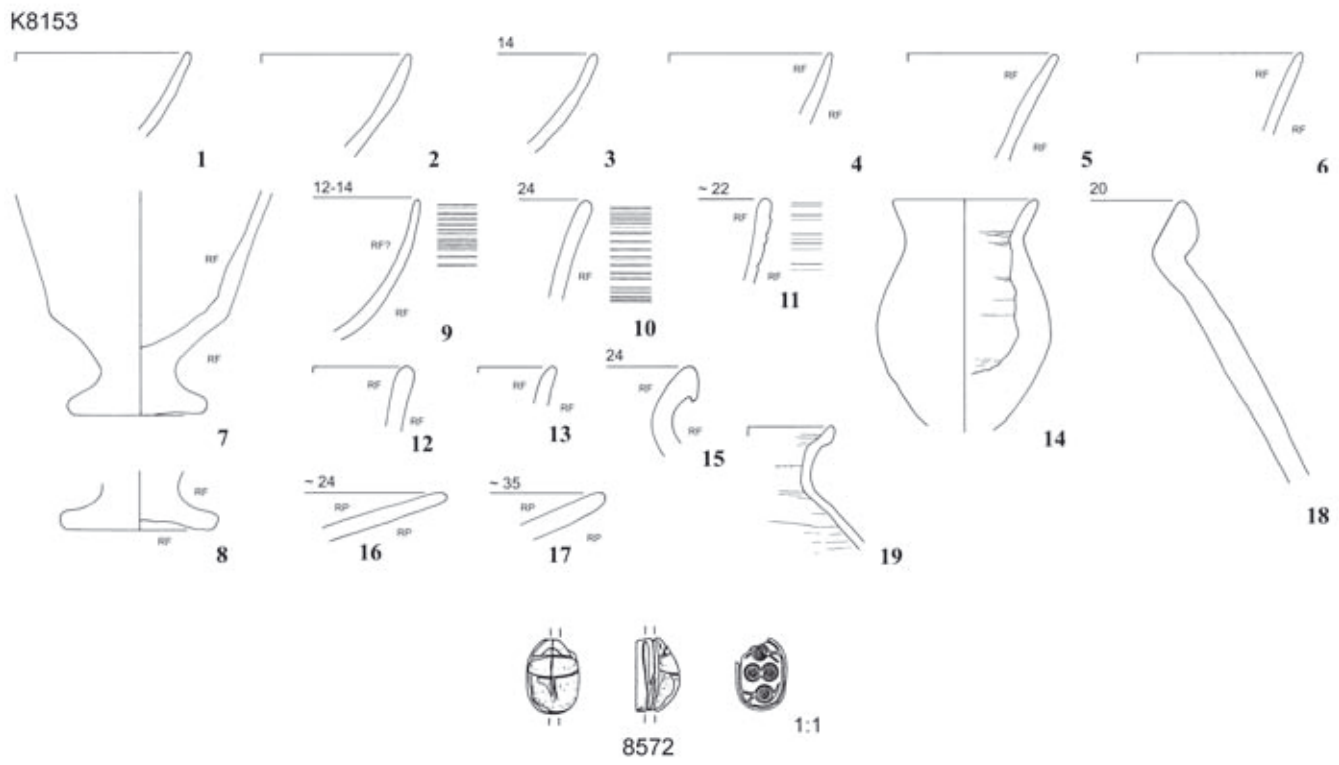
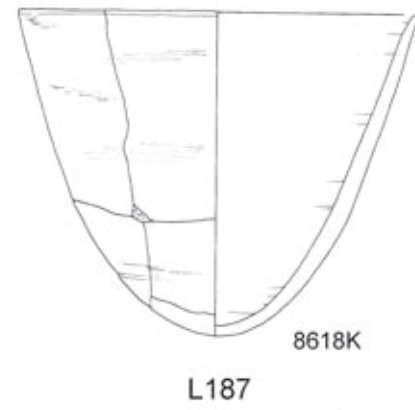
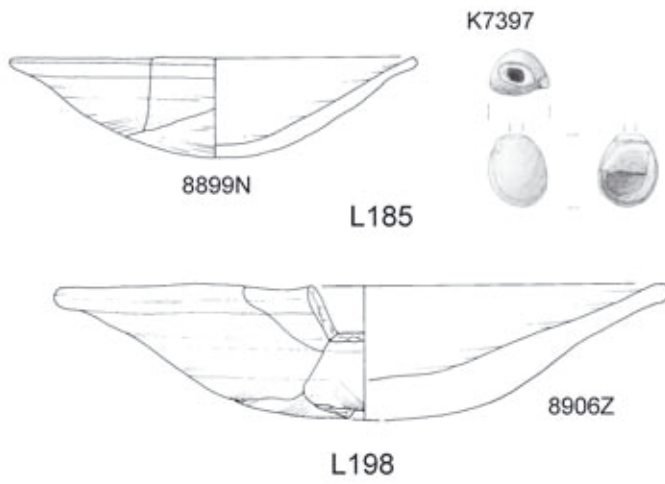
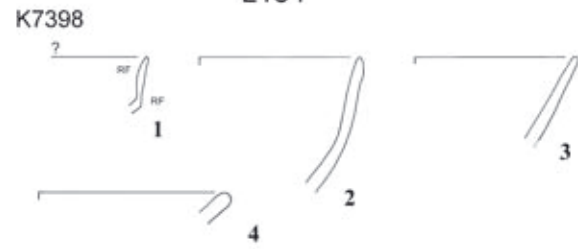
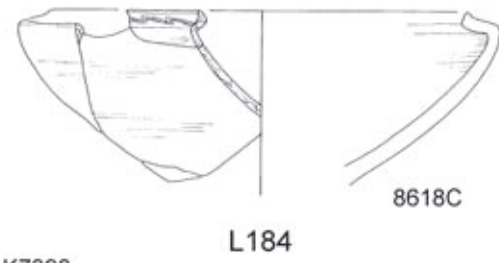
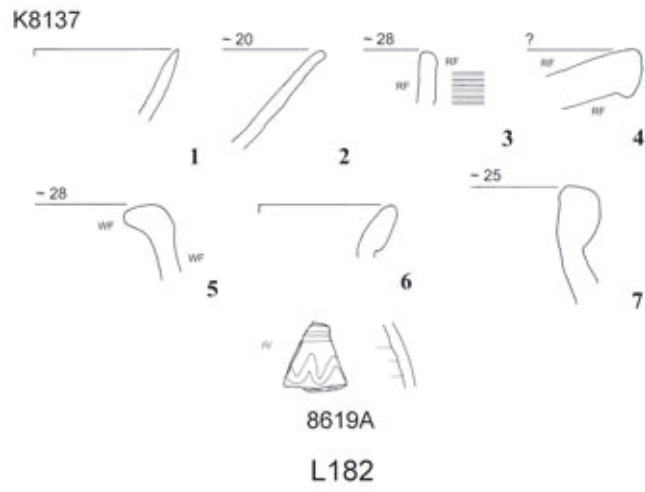



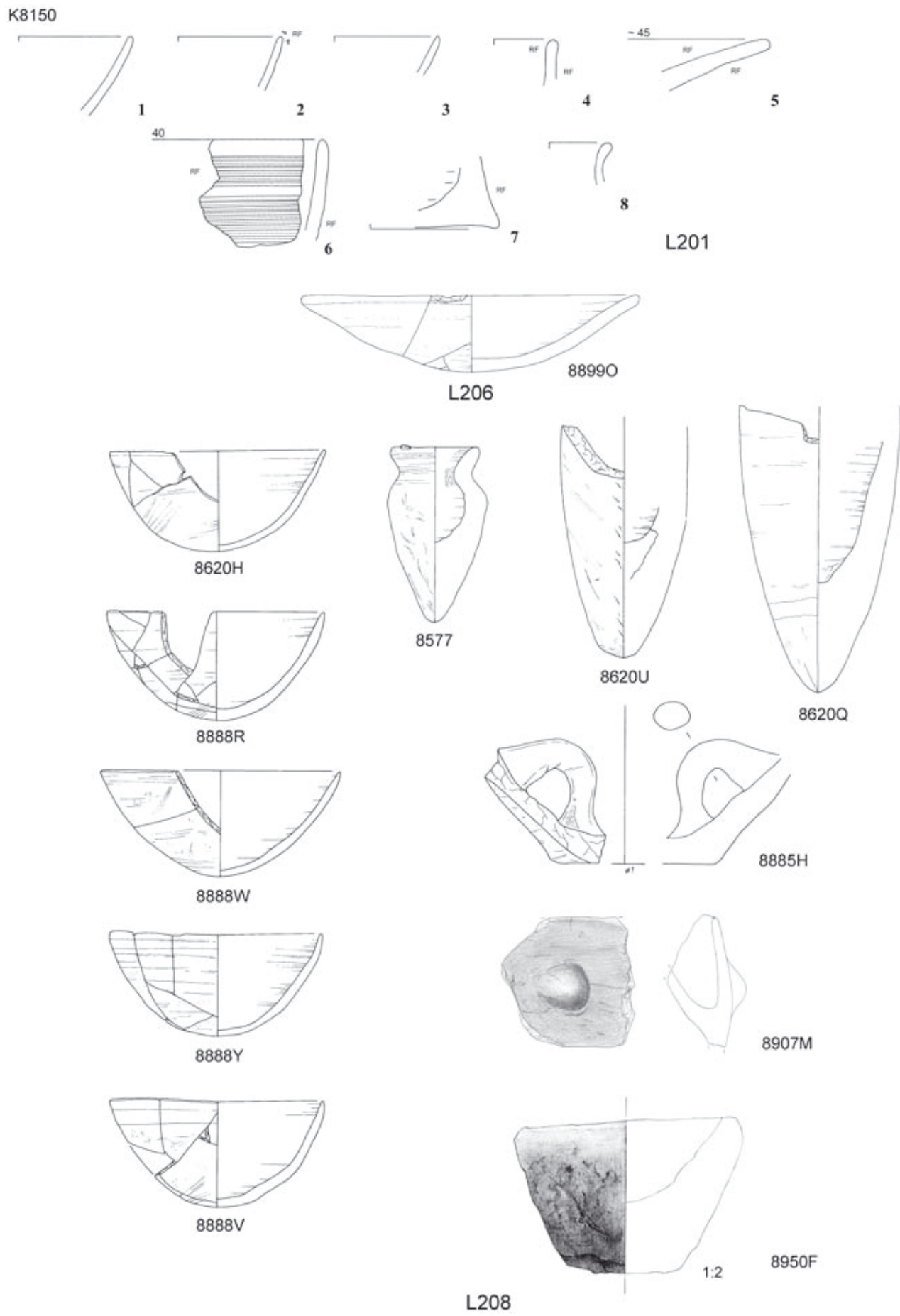



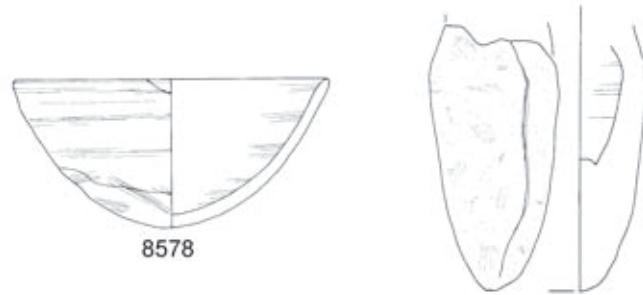

L209

K7571

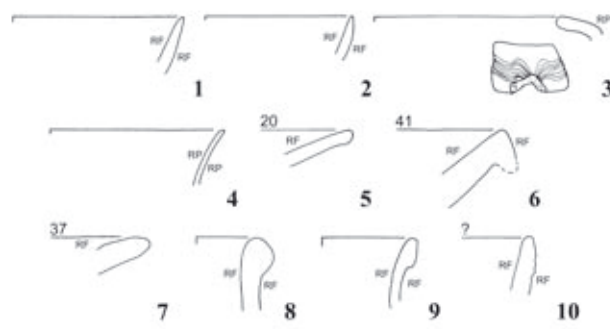

L211

K7559

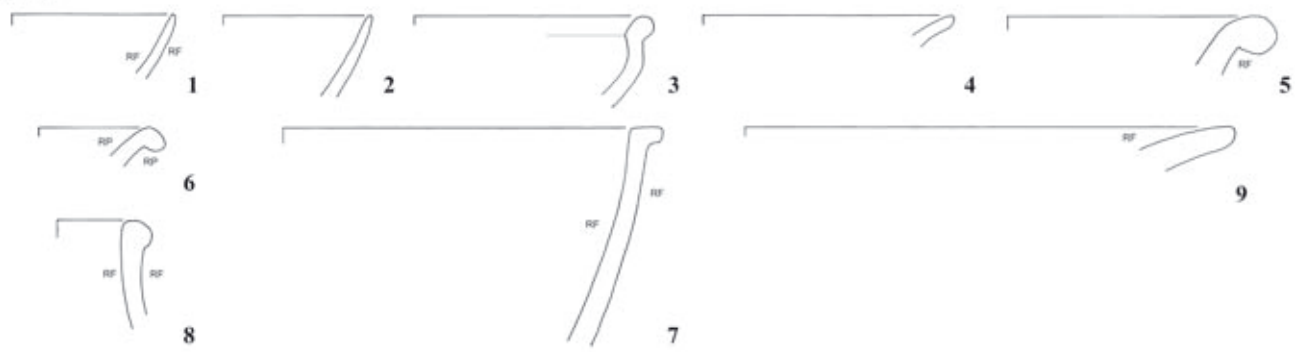

L212/213

K7423

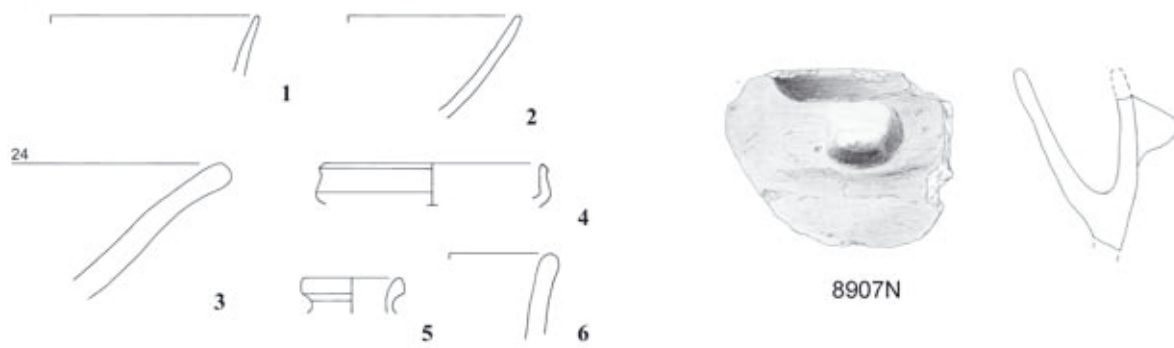

L216

K7688

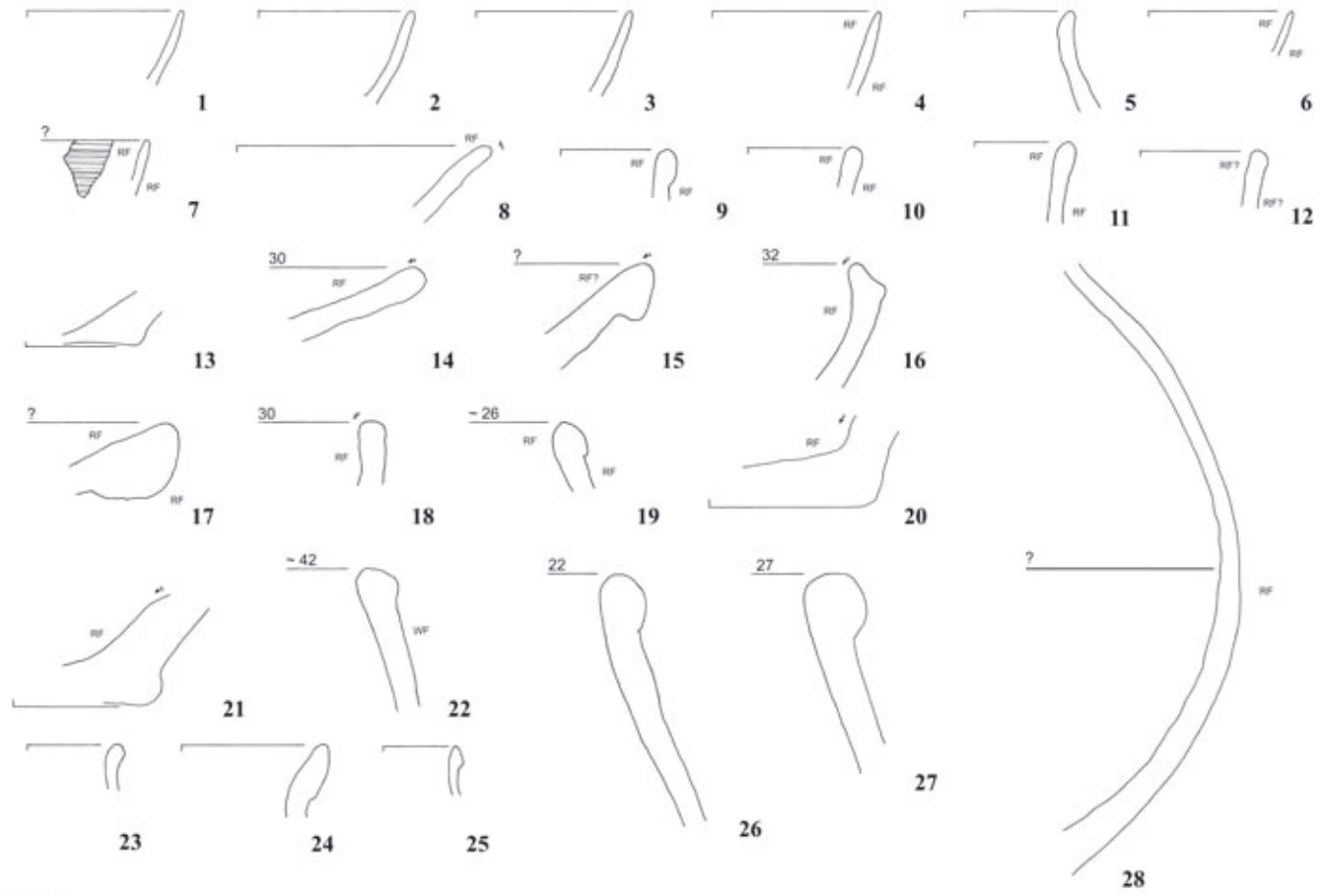

K7692

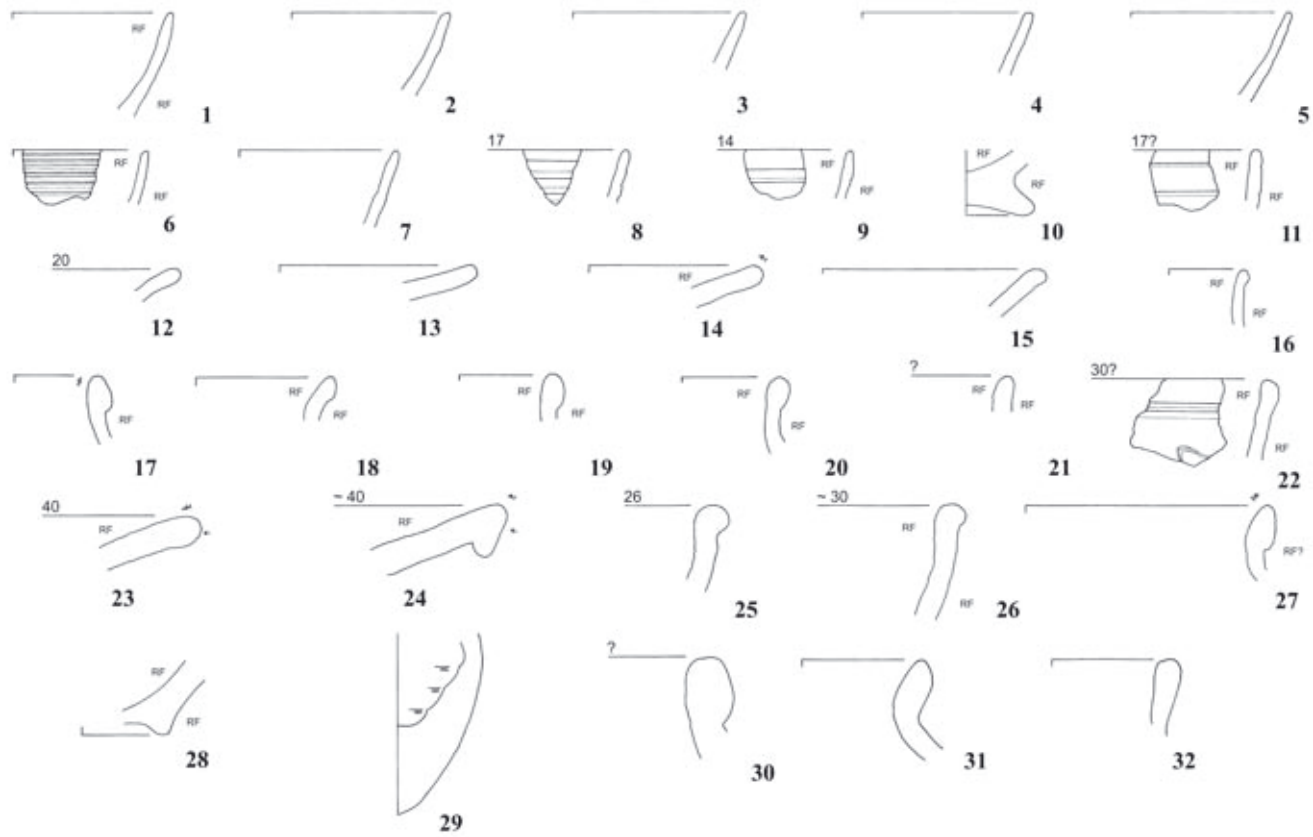

L217

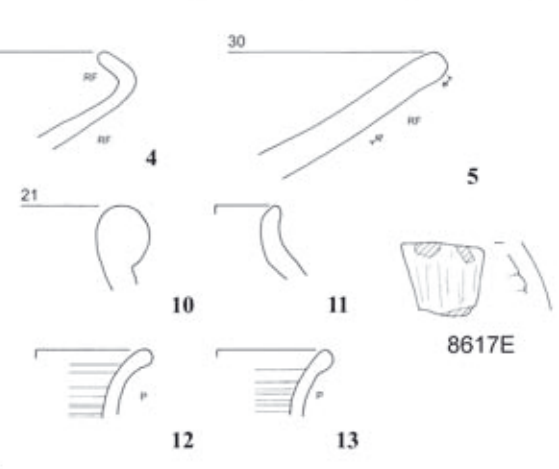
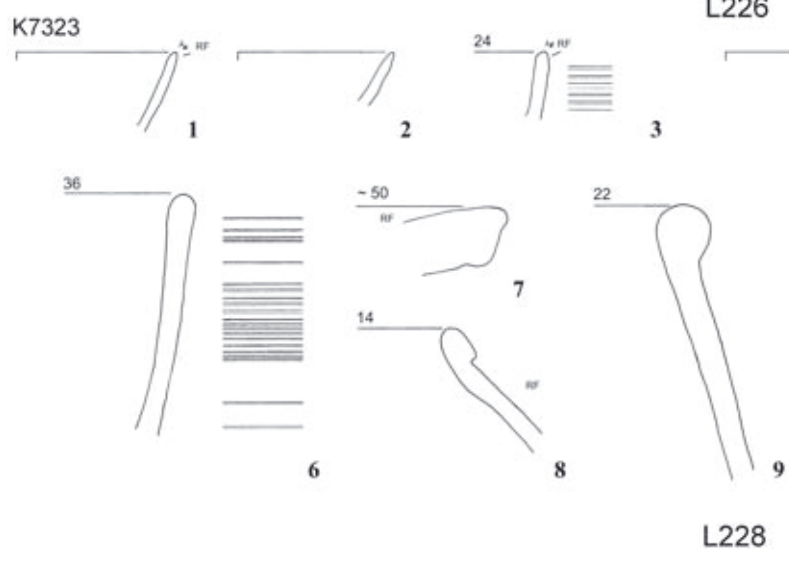
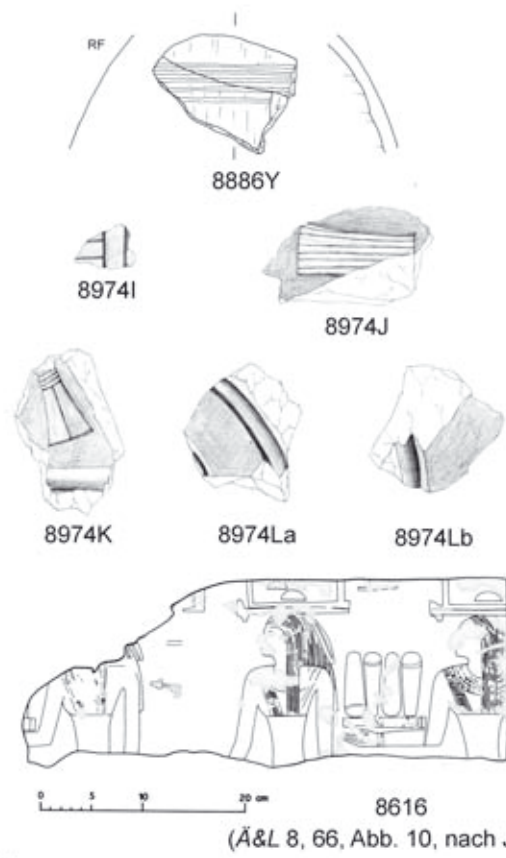
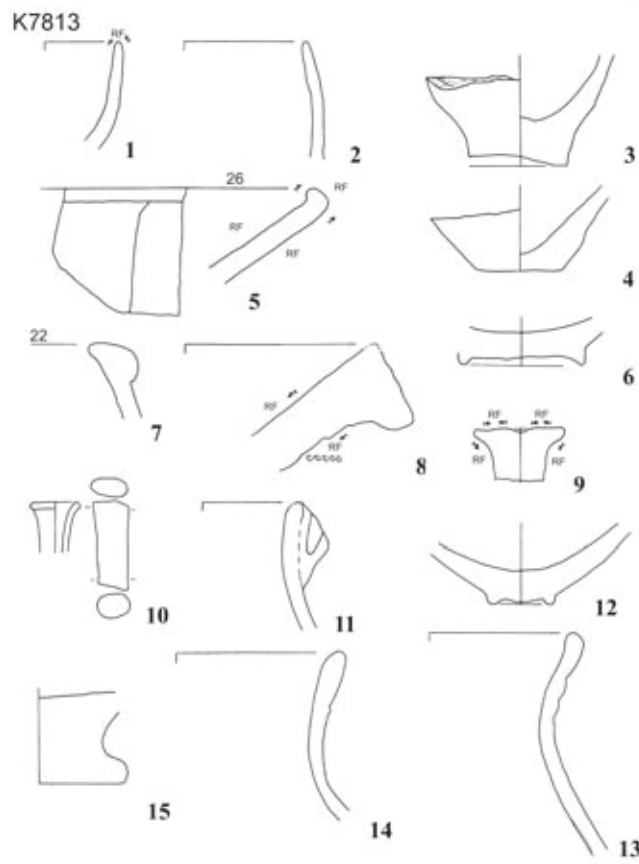
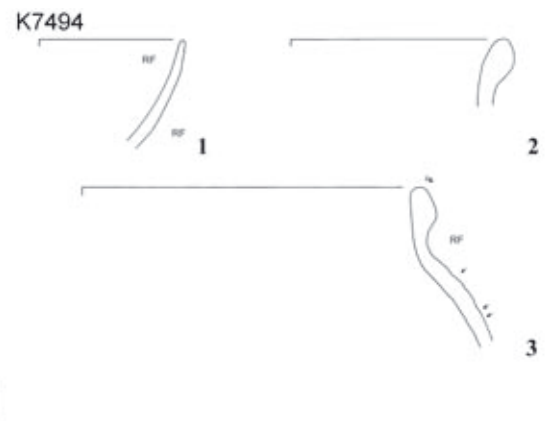
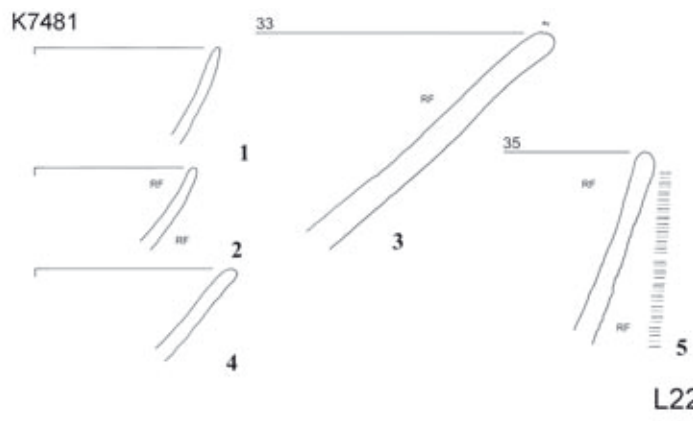

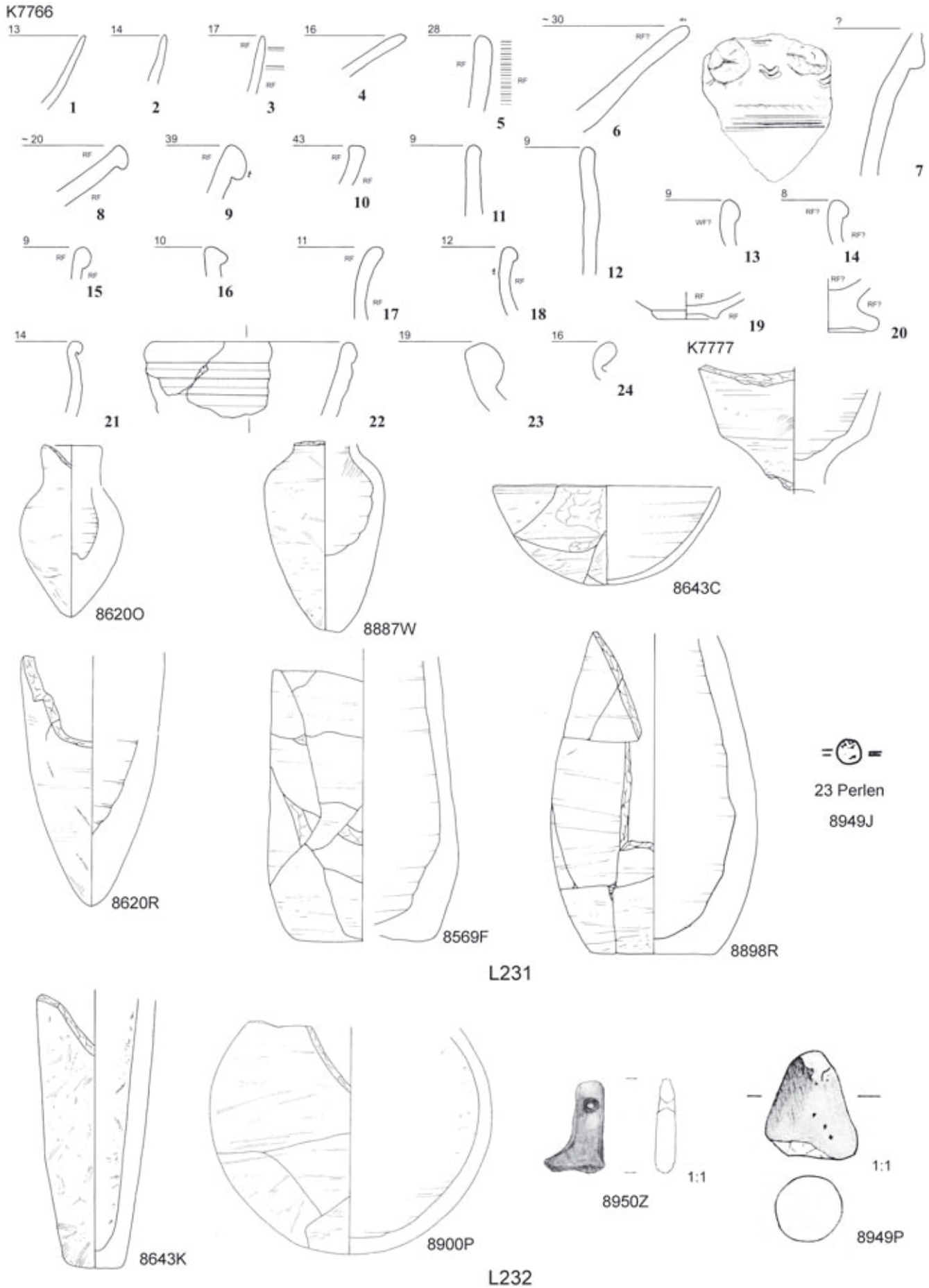

Tafel 65

K7324

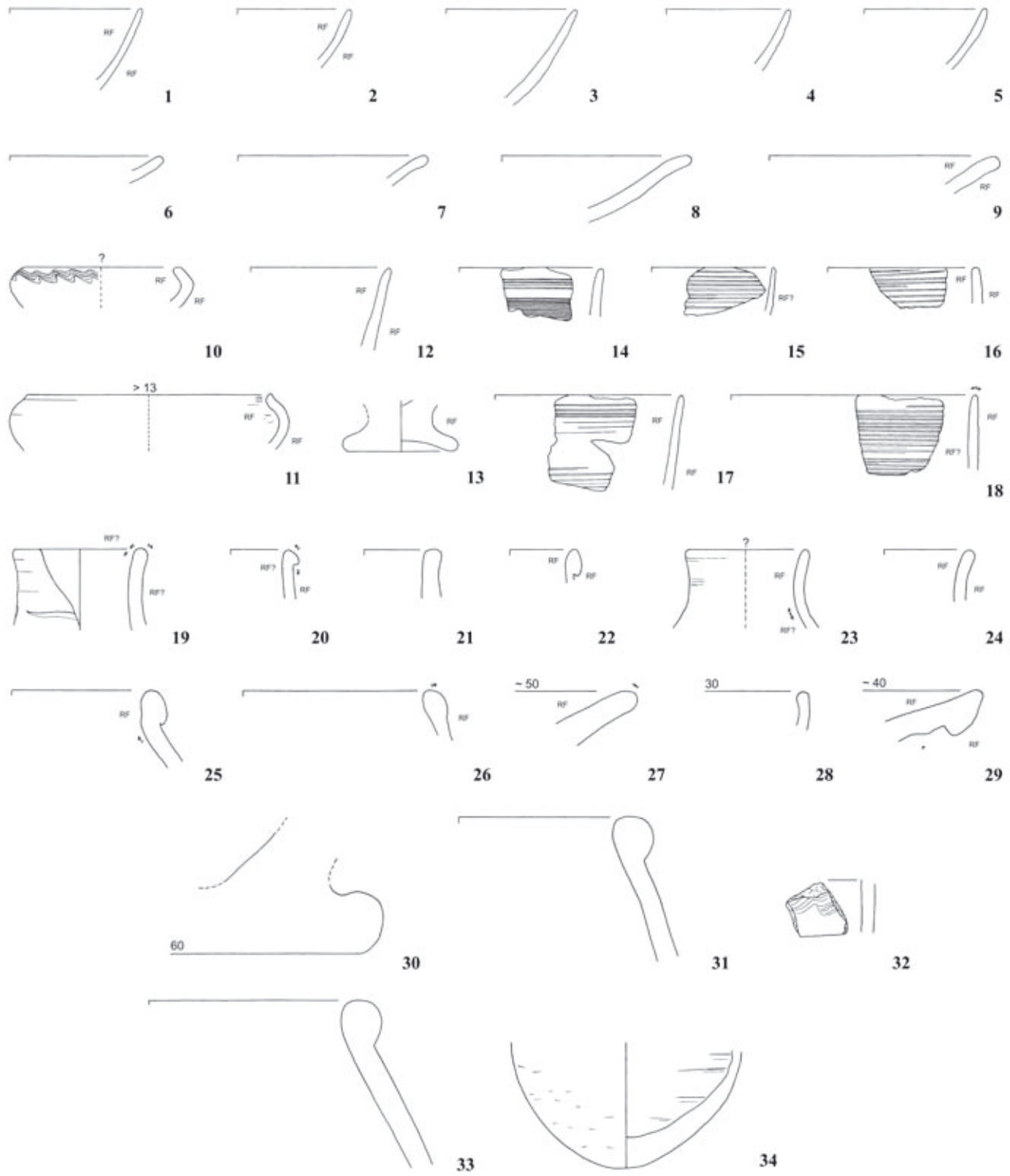

L234 (1)

K7325

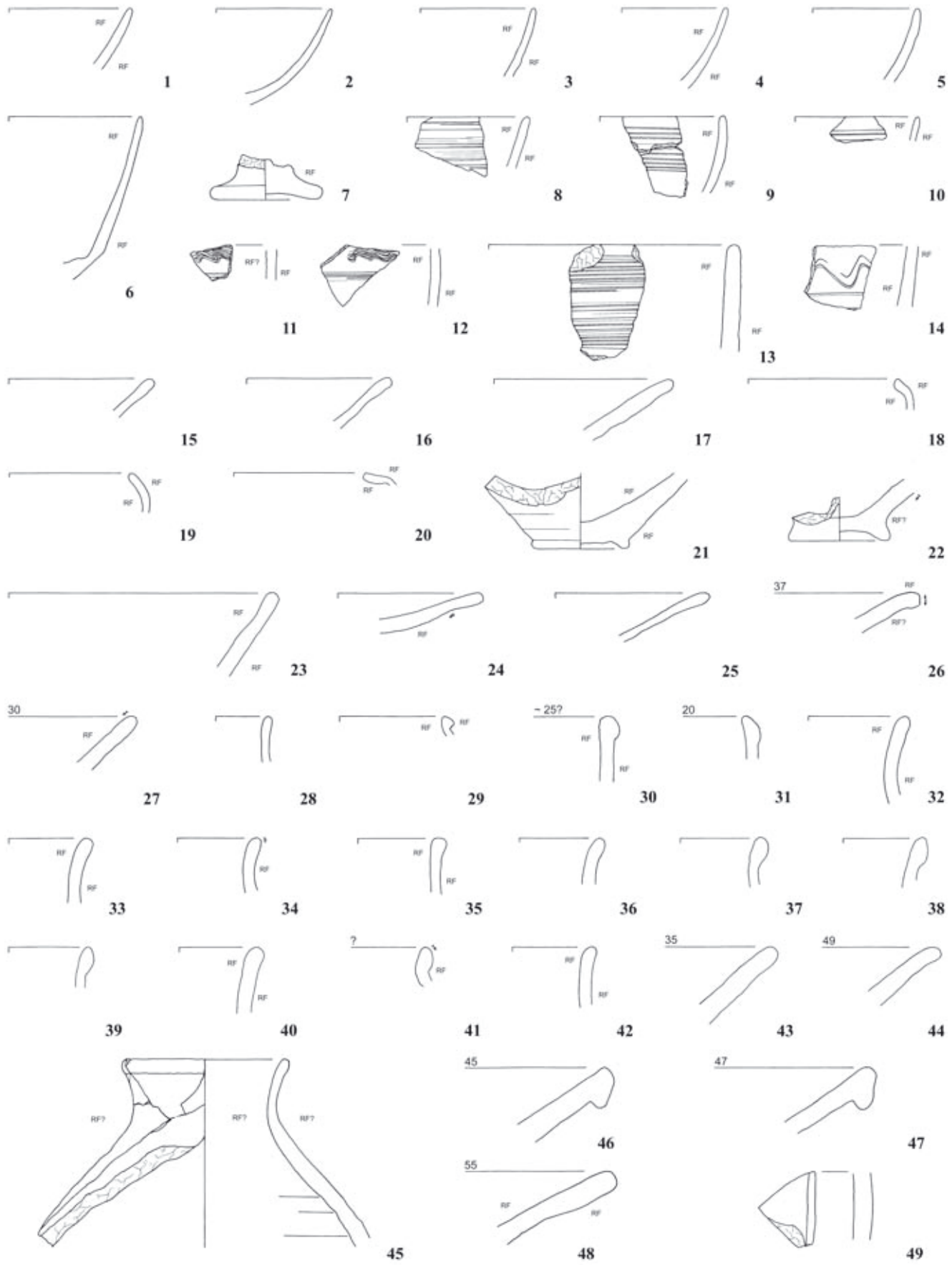

L234 (2)



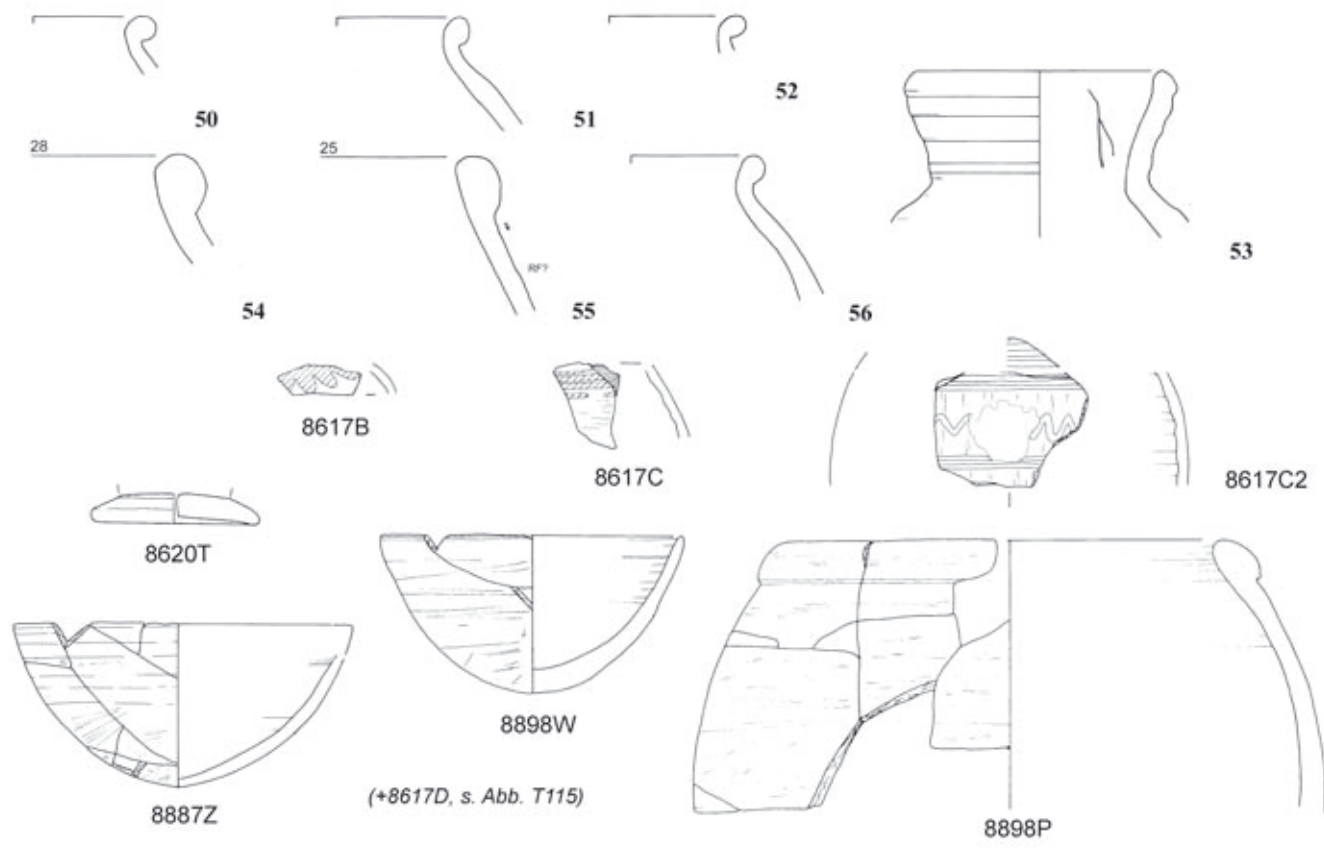

L234 (3)

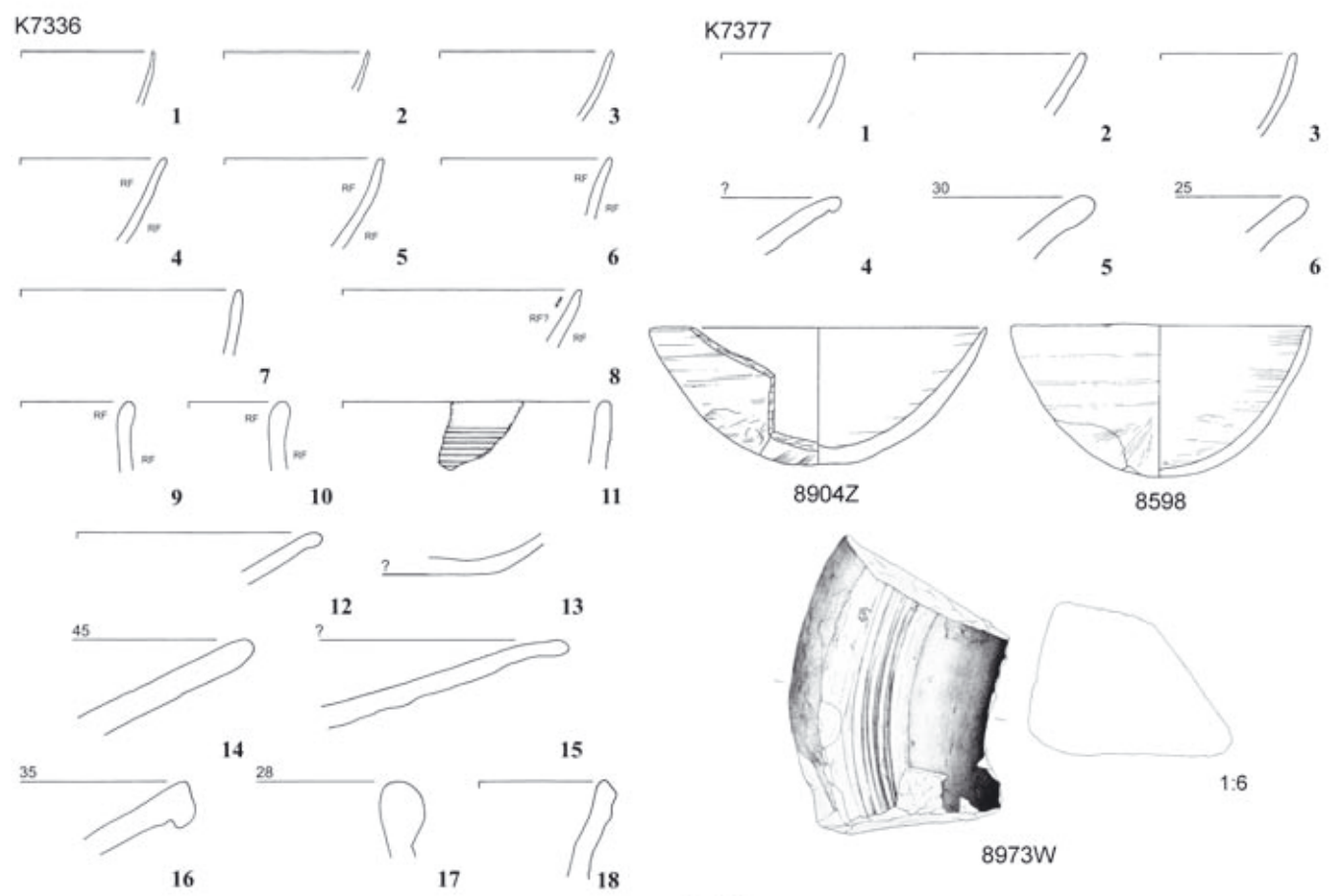

L235



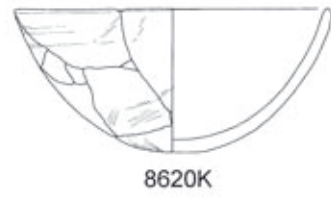

8620K



8620P

L238

K8411

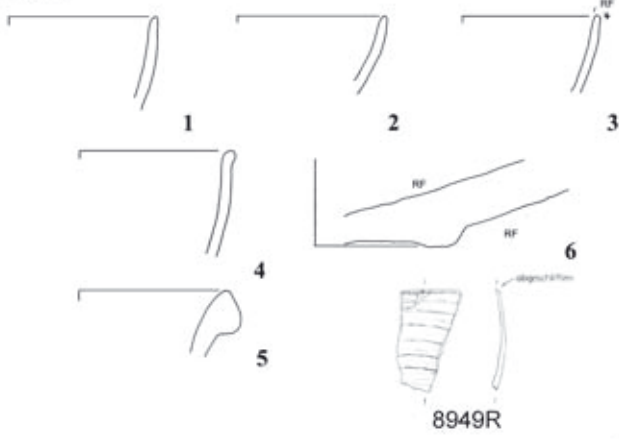

8949R

L239

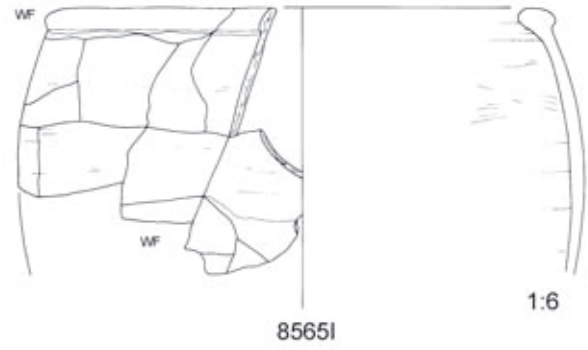

85651

1:6

K8421

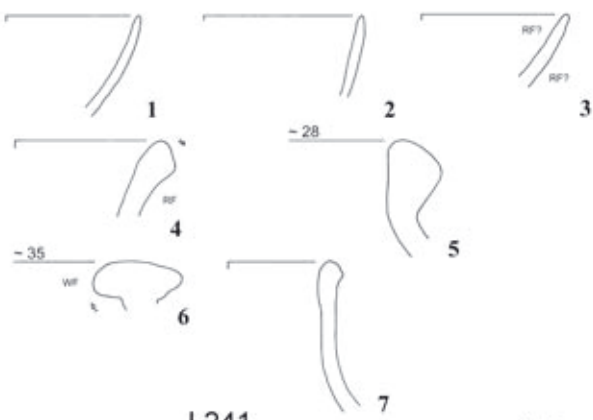

L241

K7821

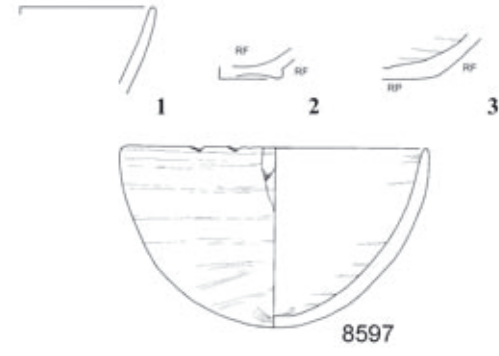

8597

L242

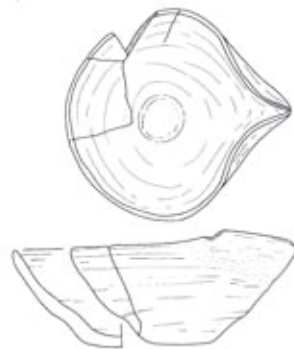

8885C

L243



8888F

L244

K8151

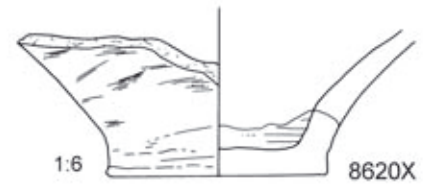
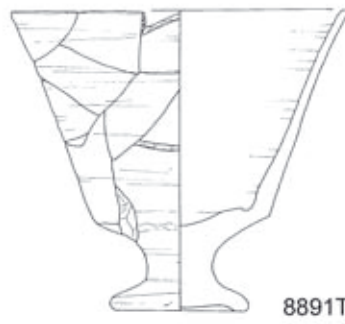
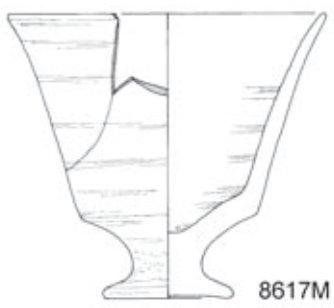
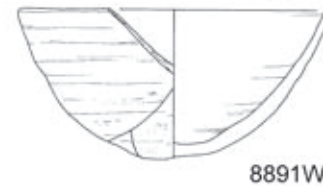
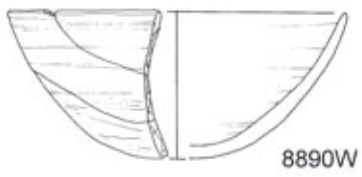
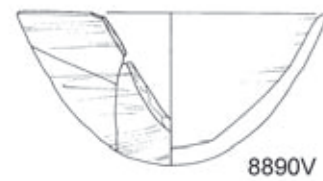
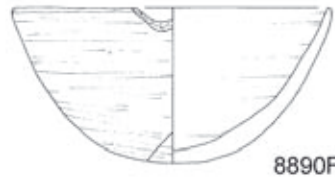
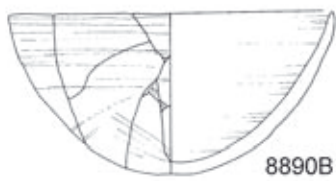
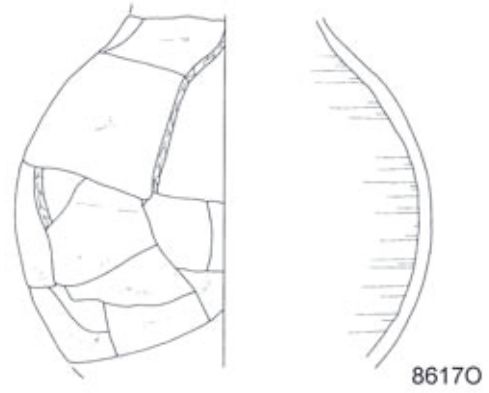
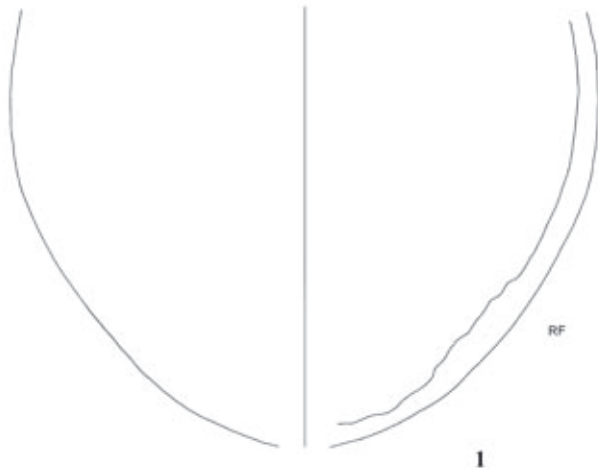

L245

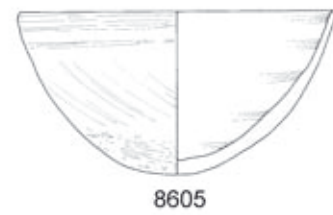
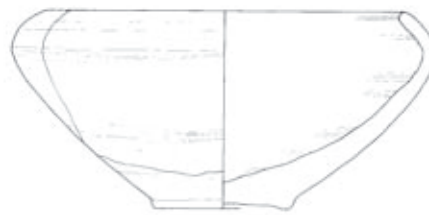
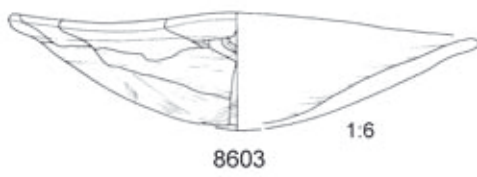

L246

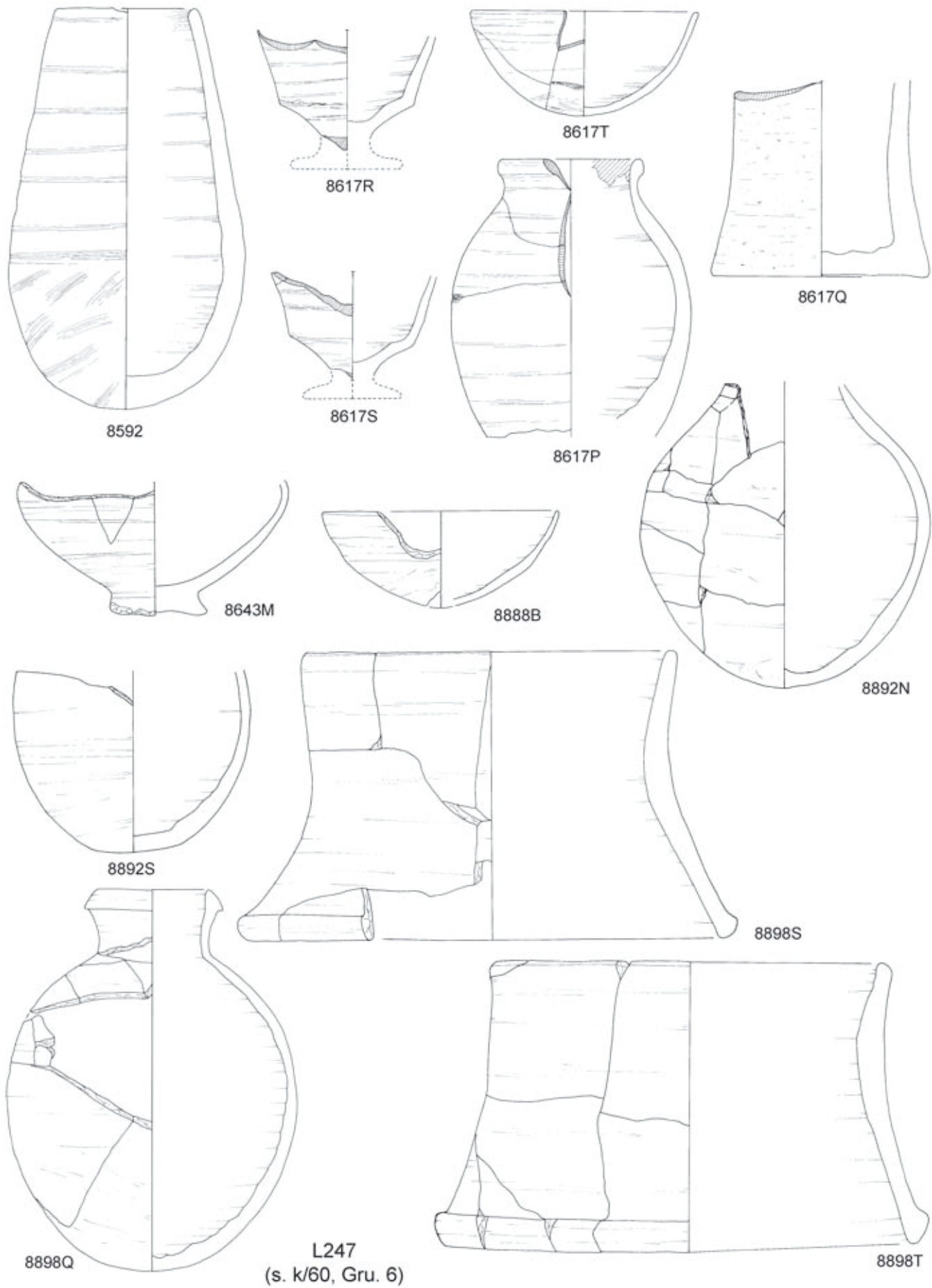

K7567

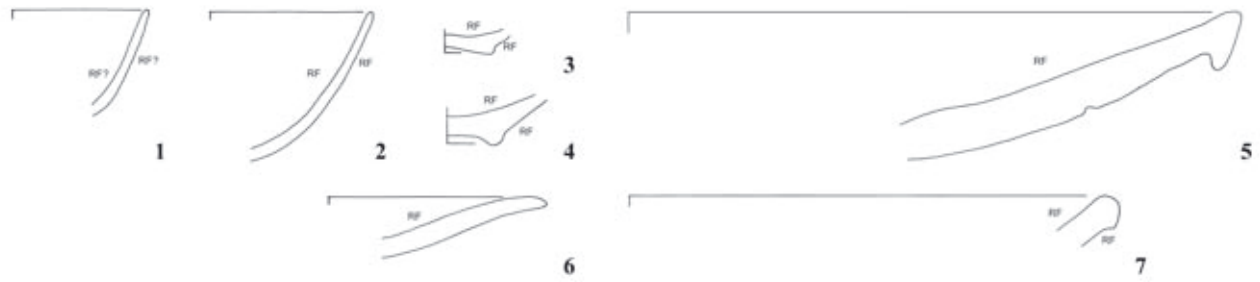

L249

K7568



L250

K7577

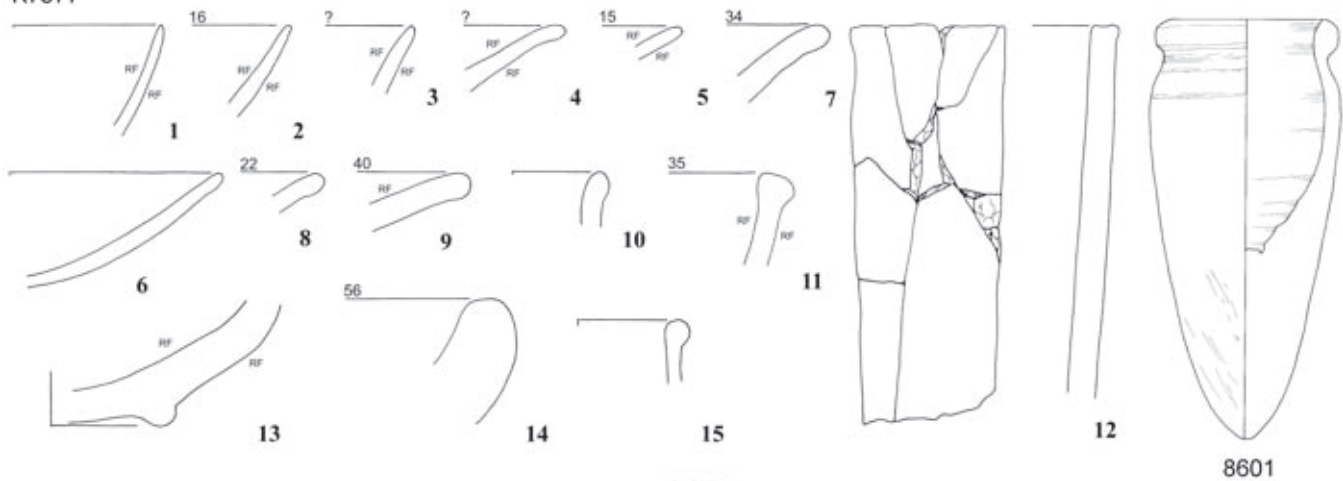

L252

K7565

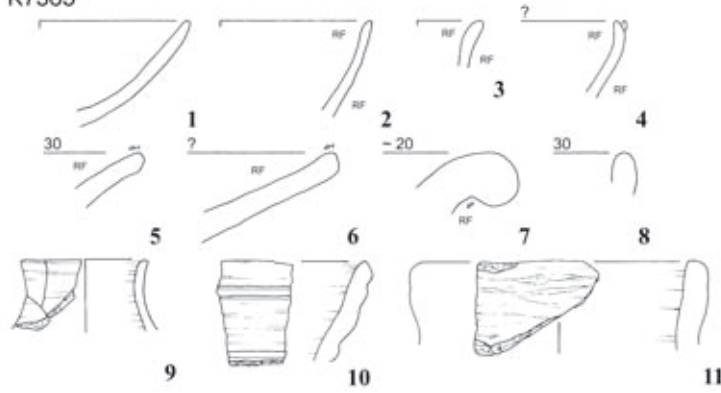

L253

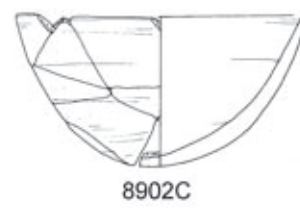

8902C

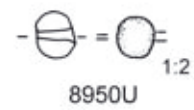

8950U 1:2

K7563

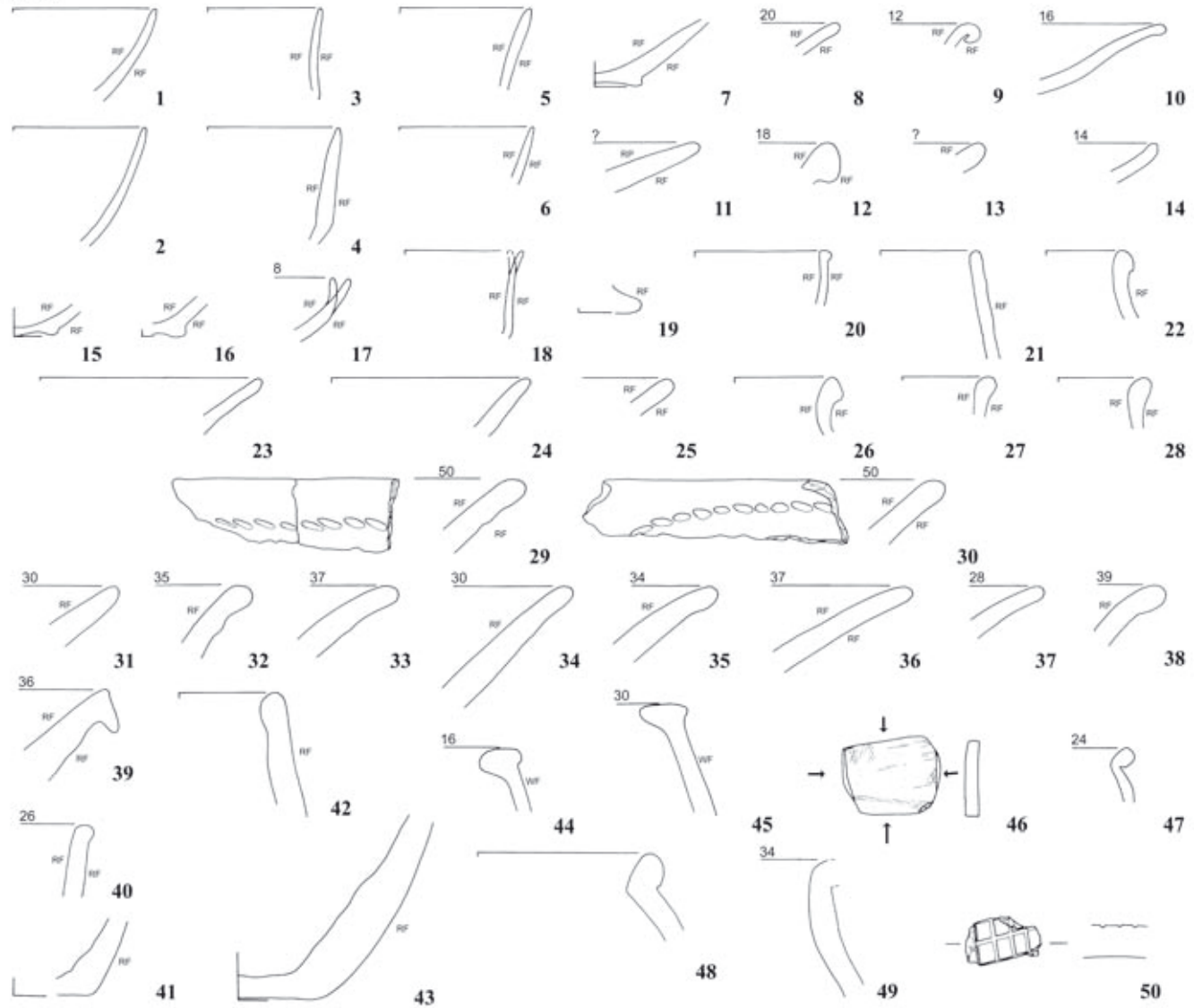

K7566

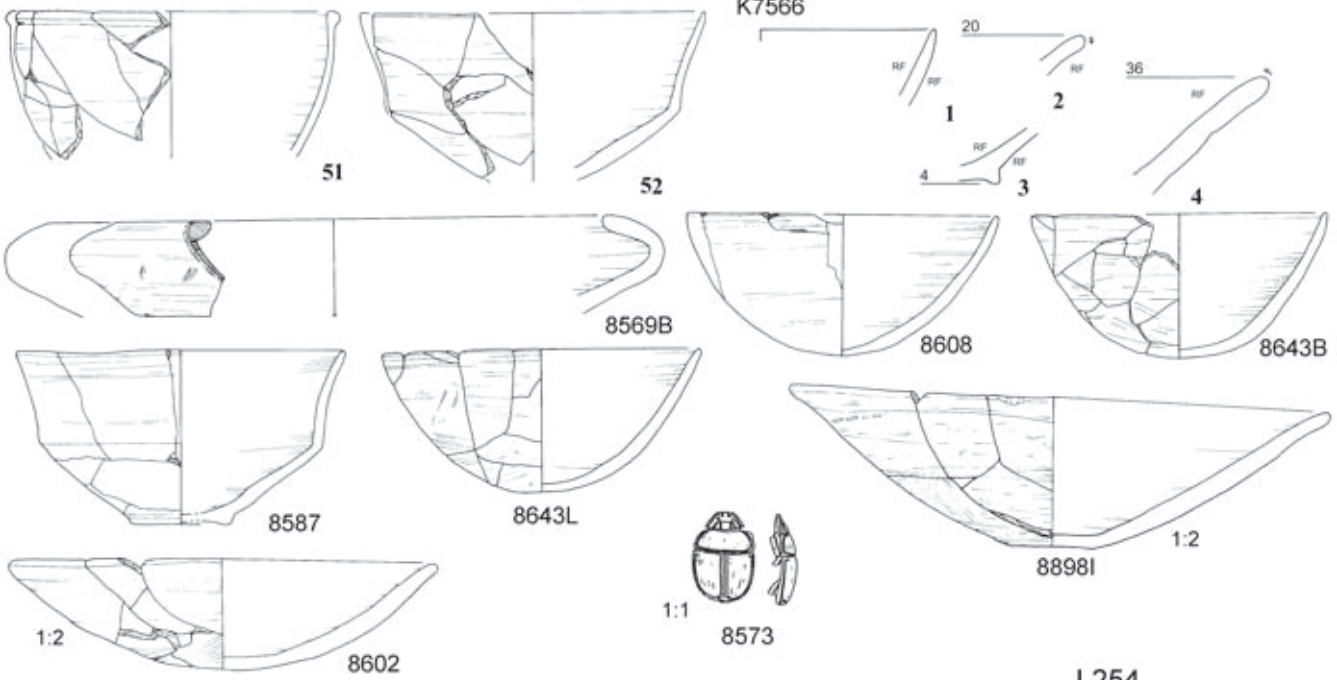

L254



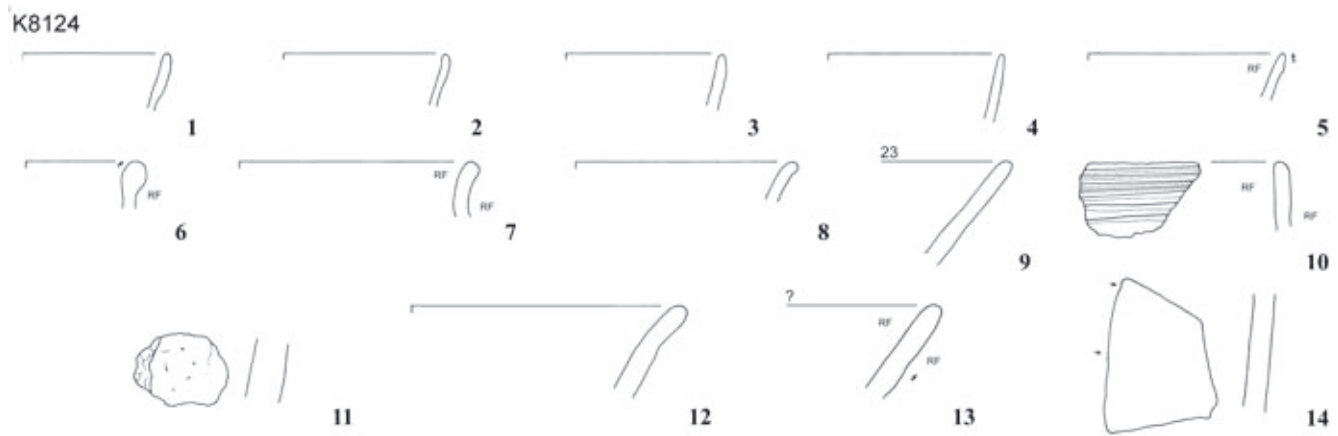
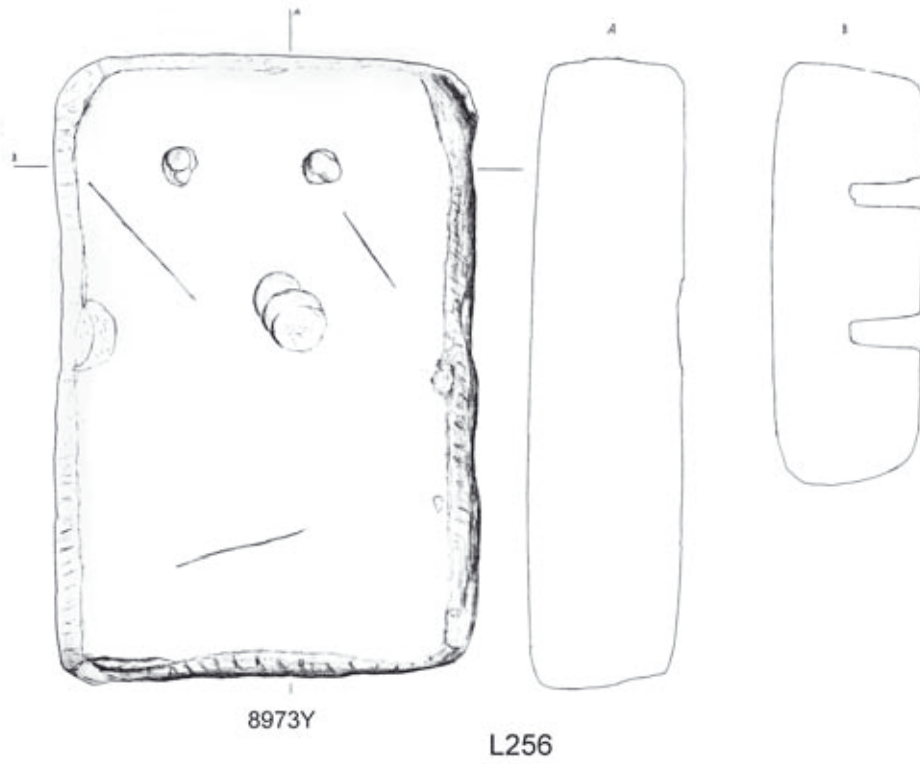
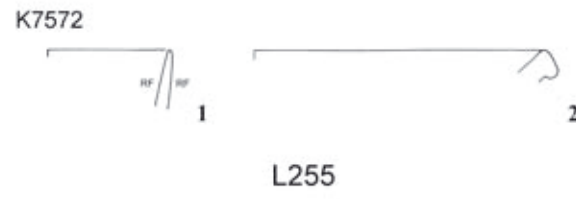

L259

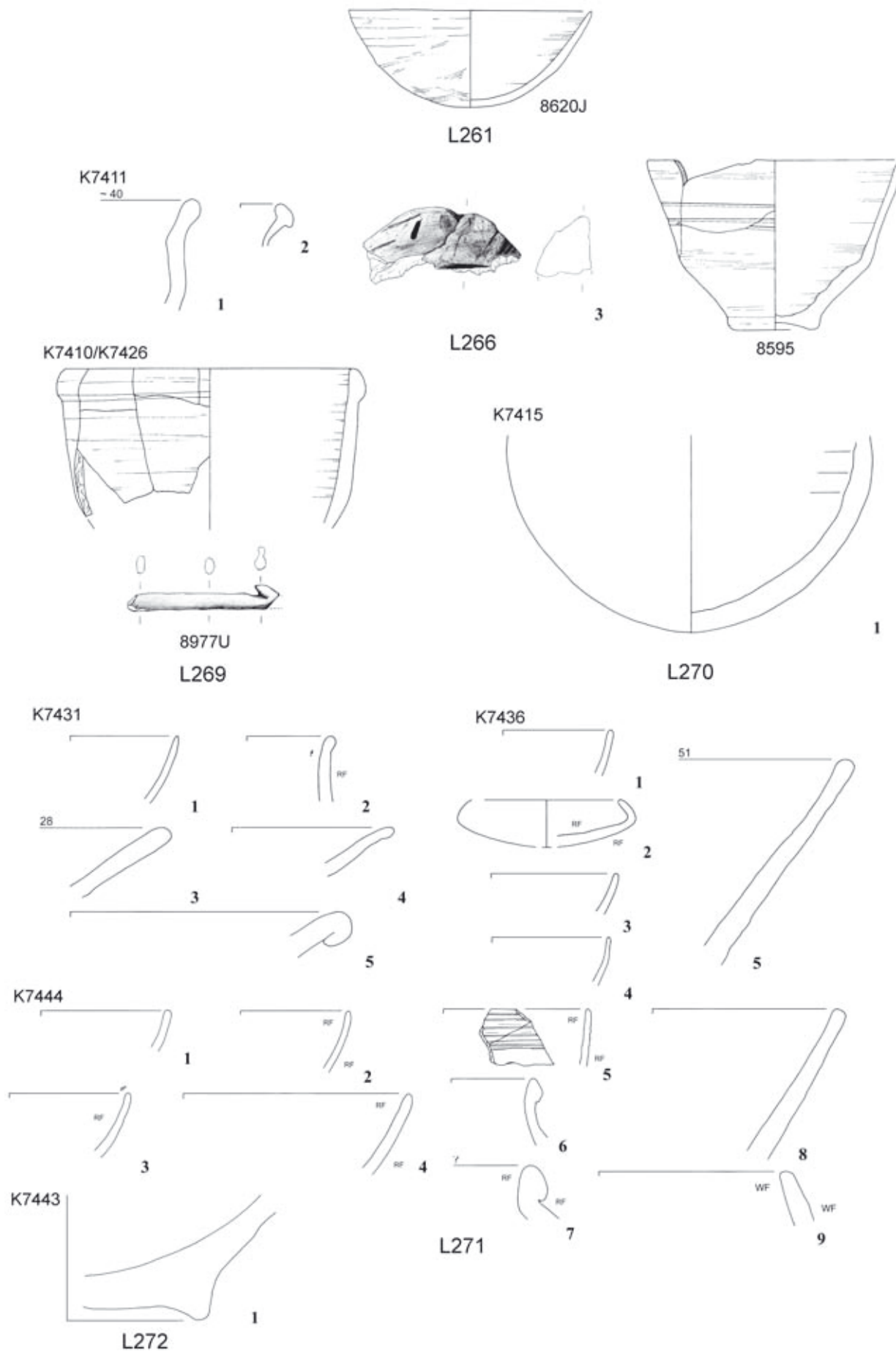



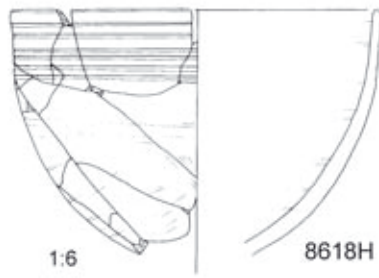
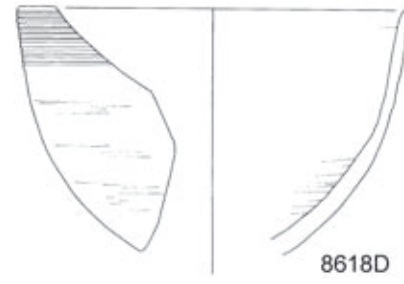
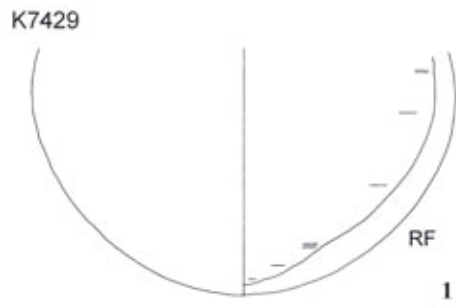

L273

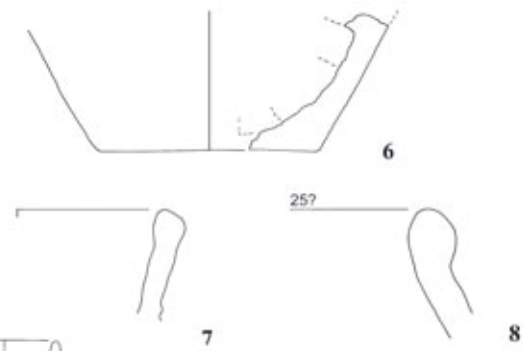
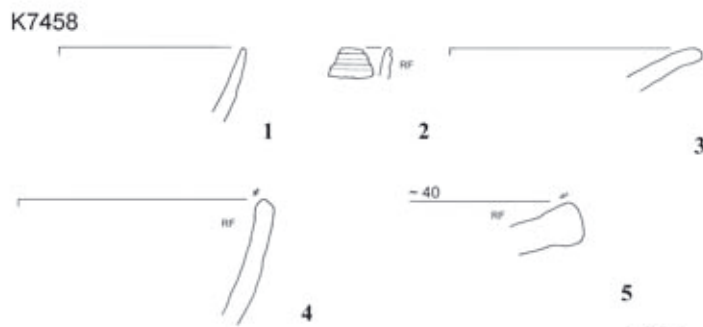
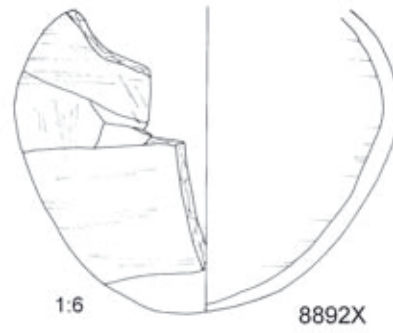

L281

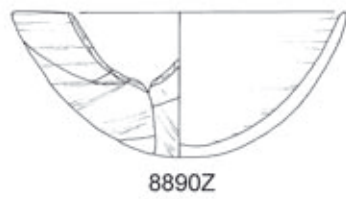

L283



L284

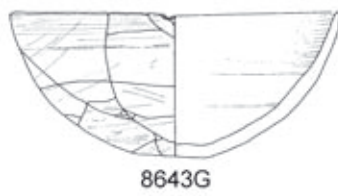
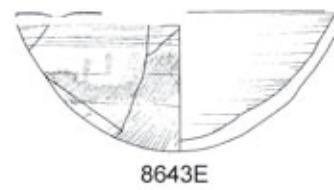
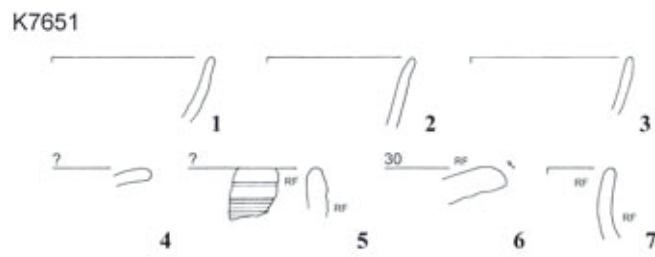

L285

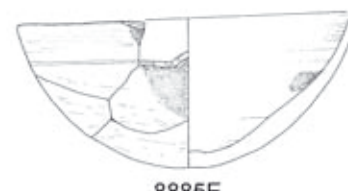
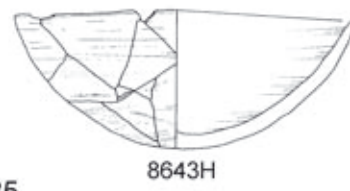



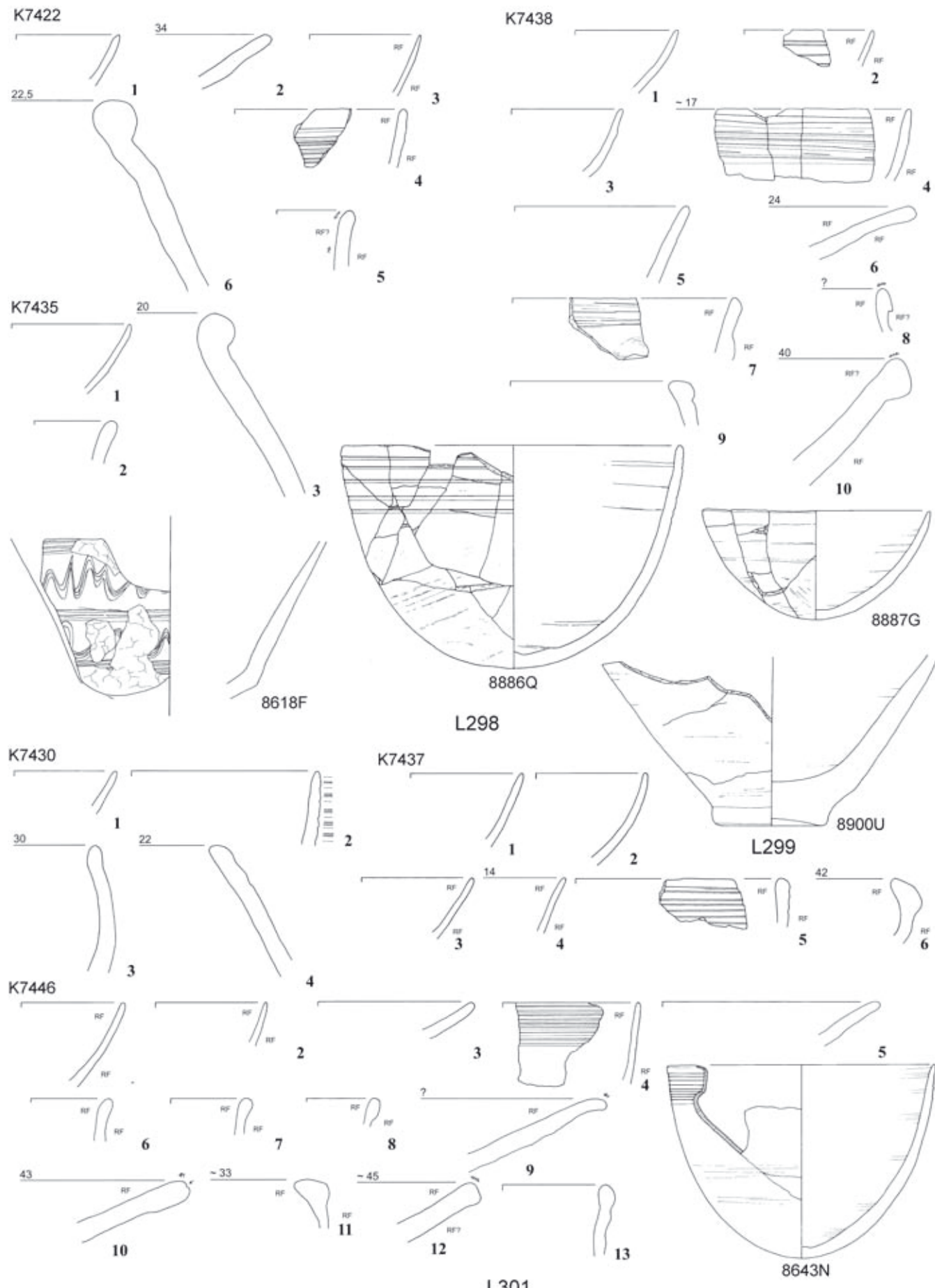

K7433

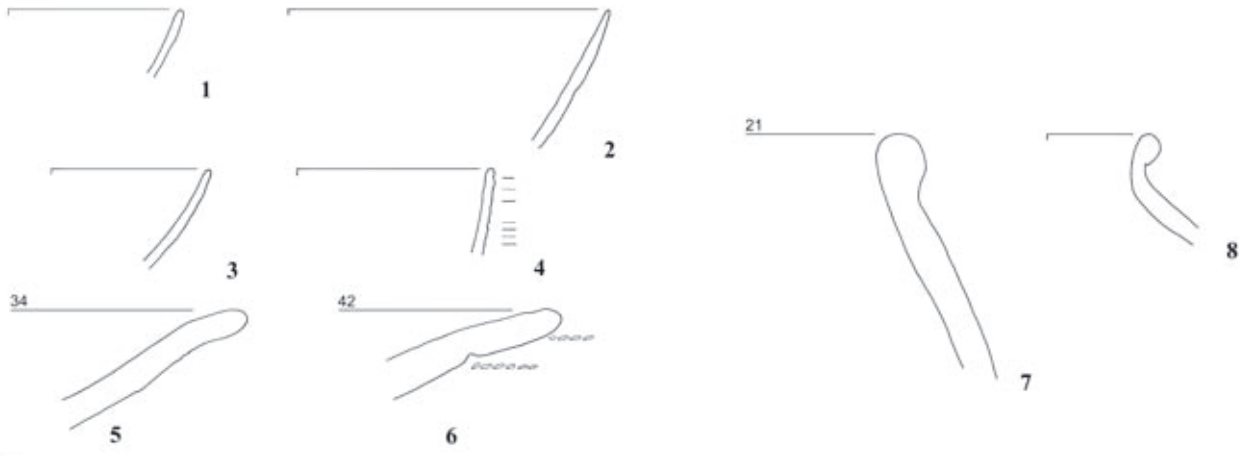

K7445

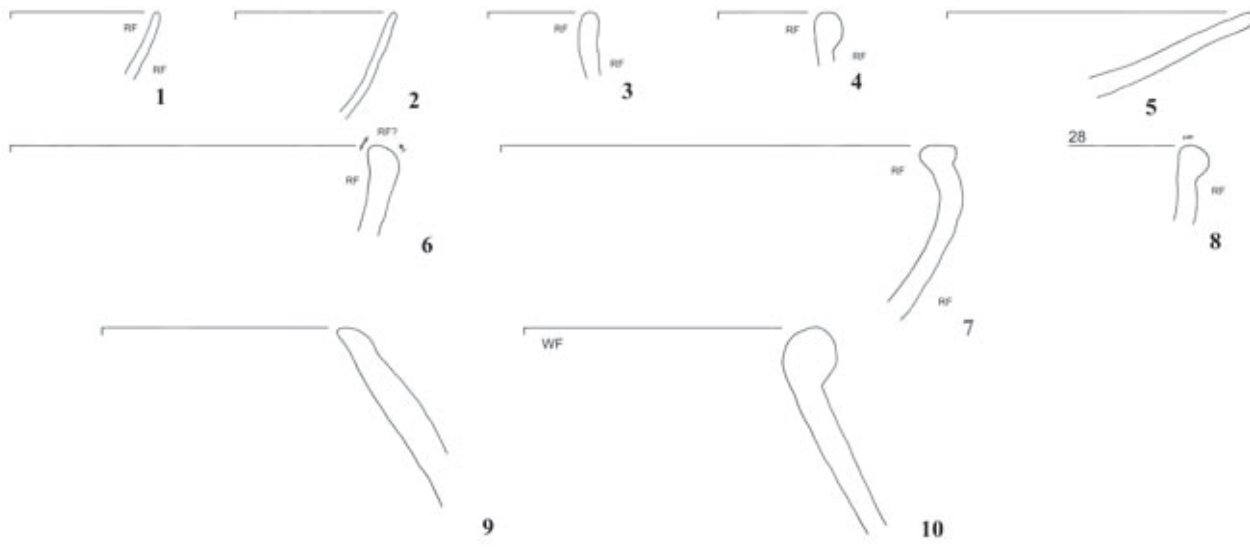

K7450

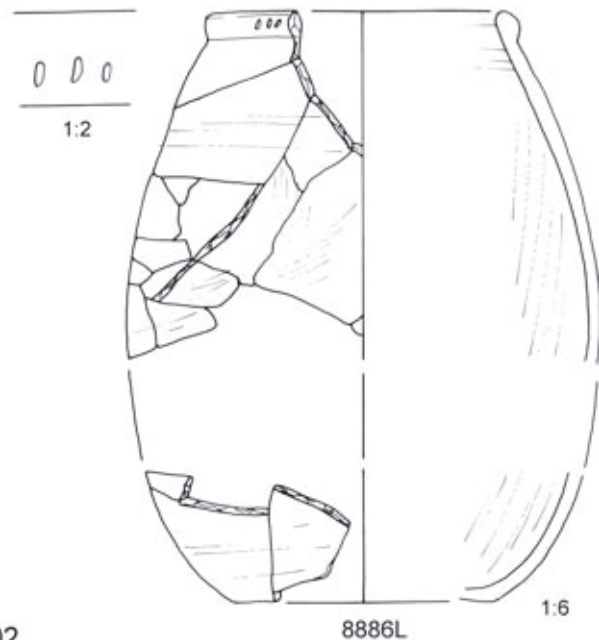
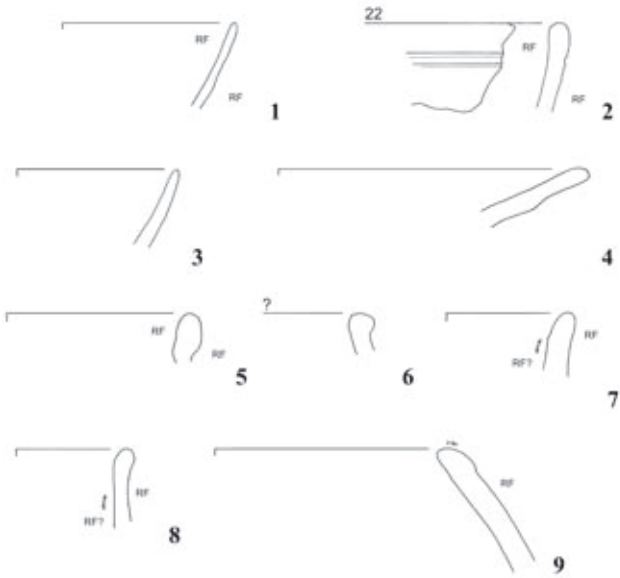

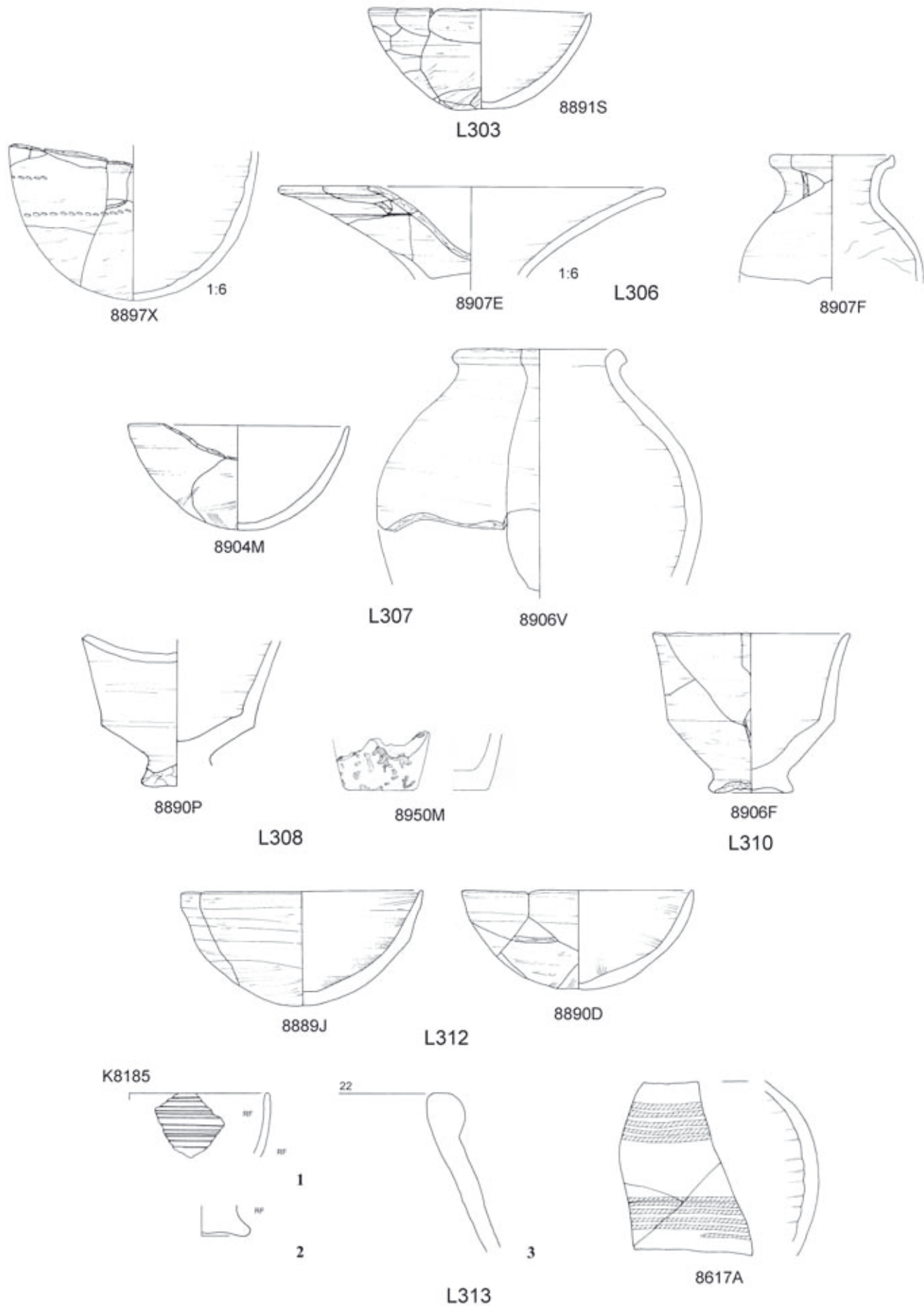

K8176

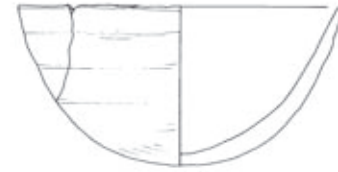

8904N  
L315

L314

K7353

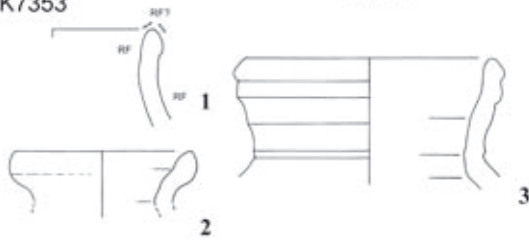

L320

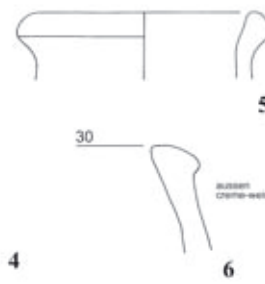

K7326

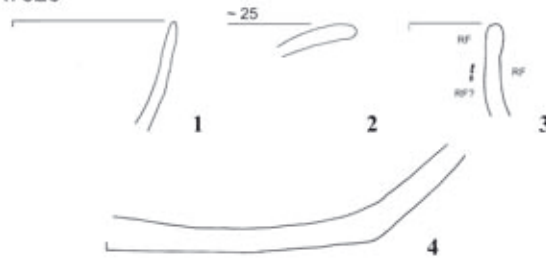

L321

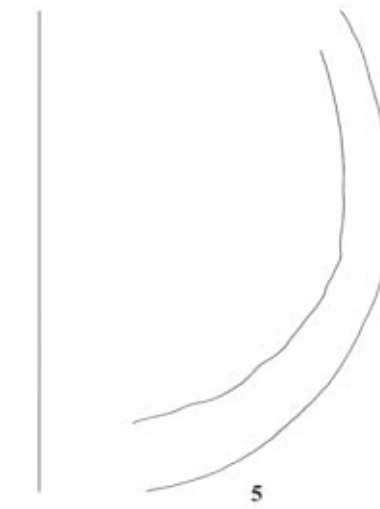

K7334

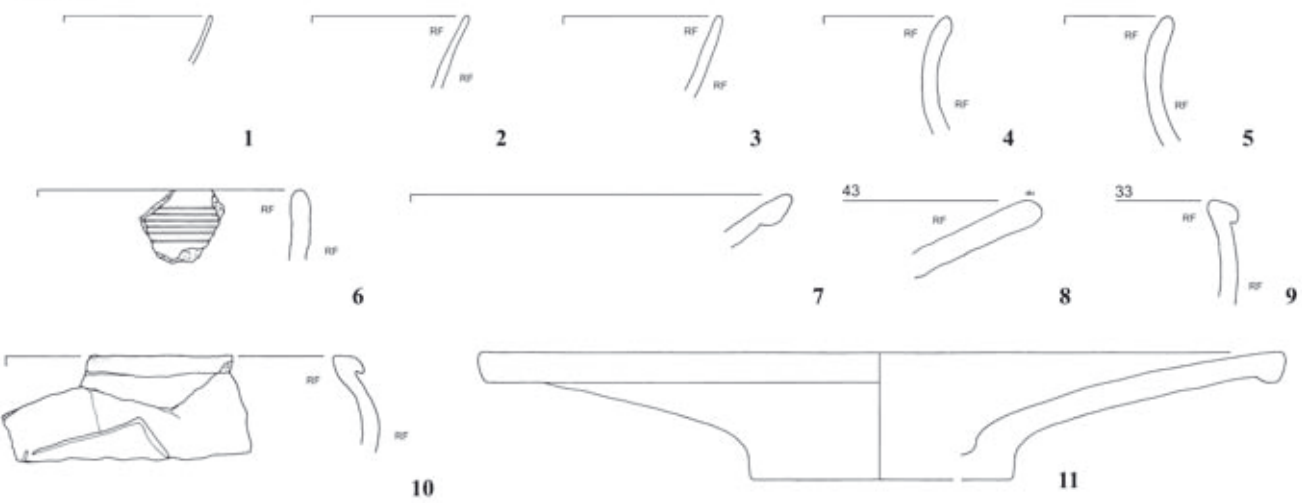

L323

Tafel 81



K7309



K7317

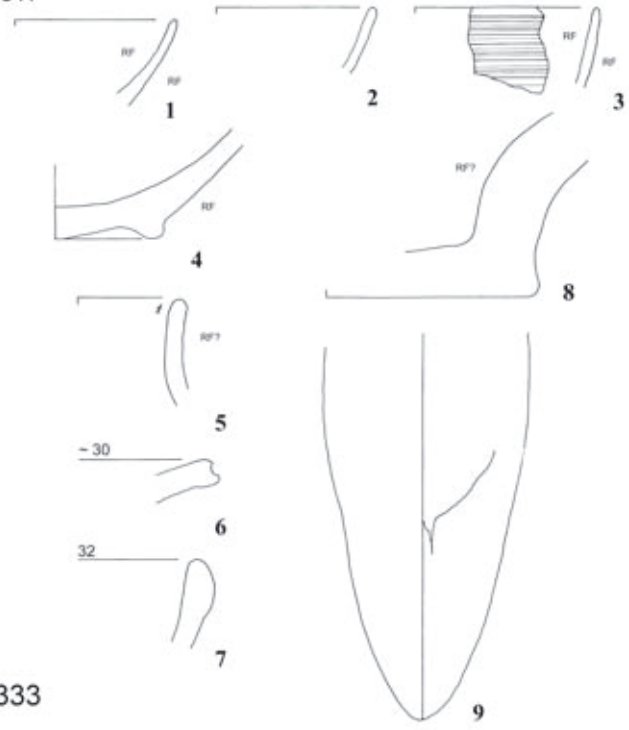

K7315

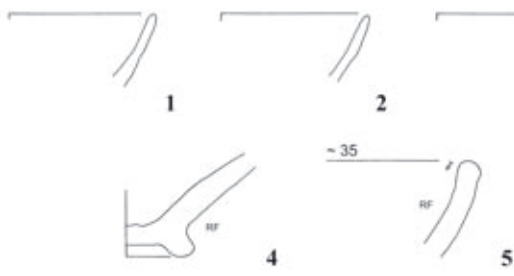

L333

K7335

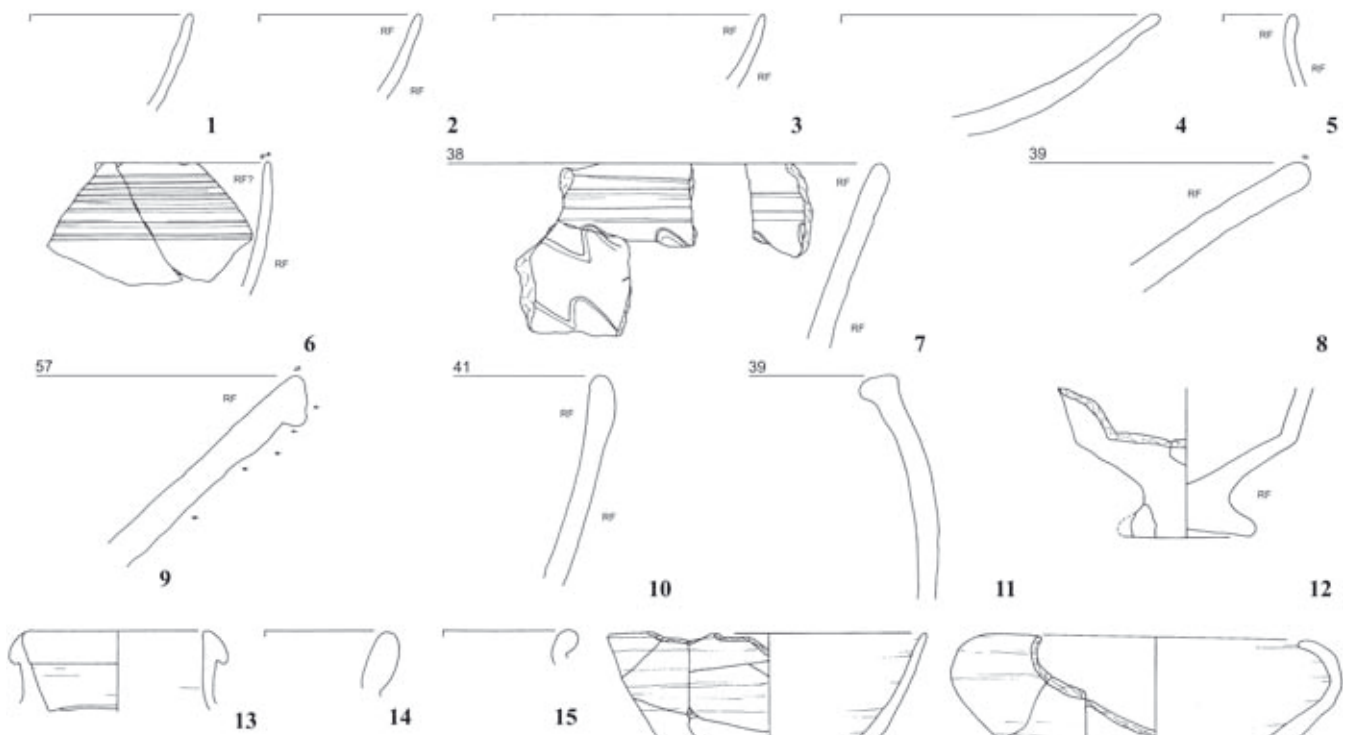

8890T

8891Y

L337

K7327



L338



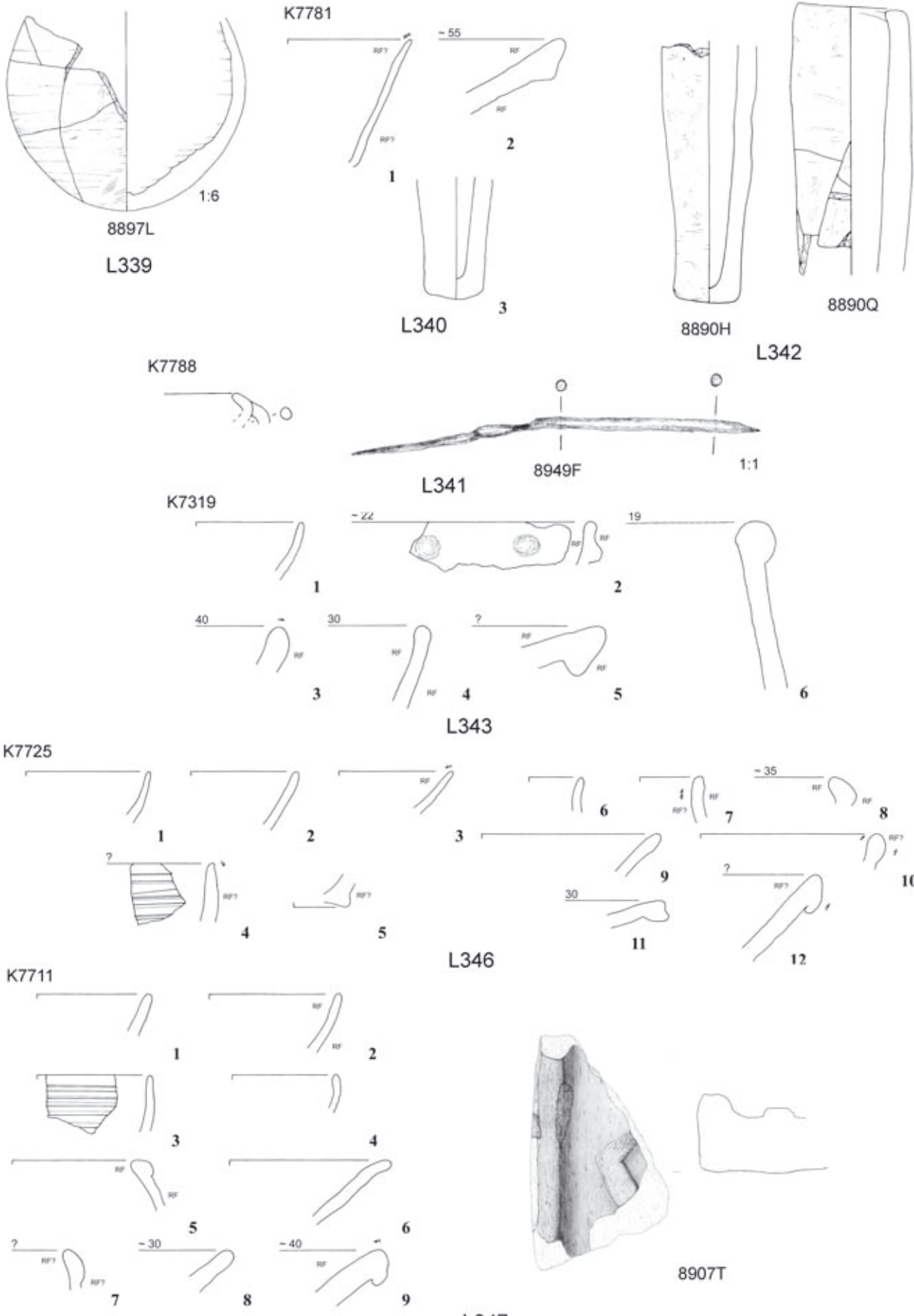

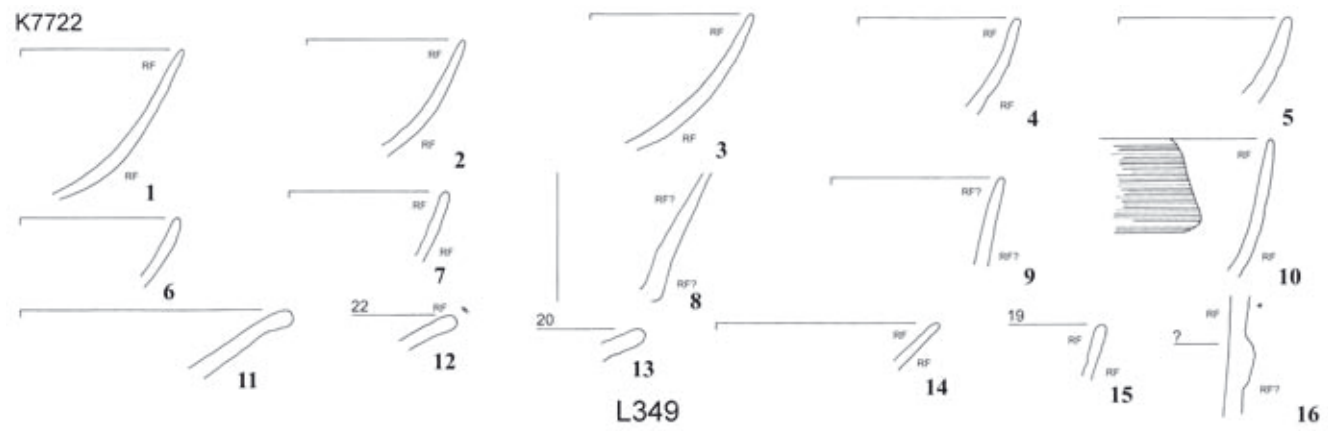

L350

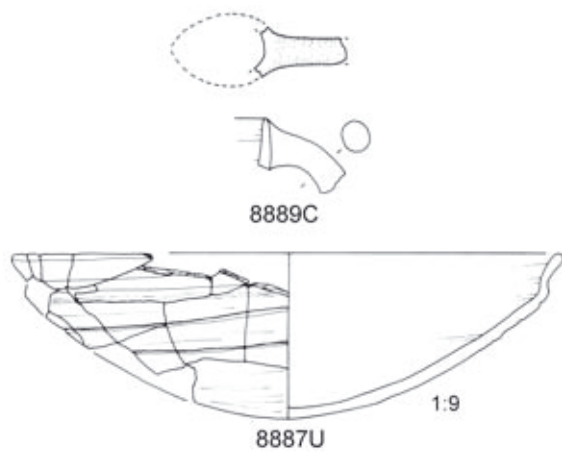
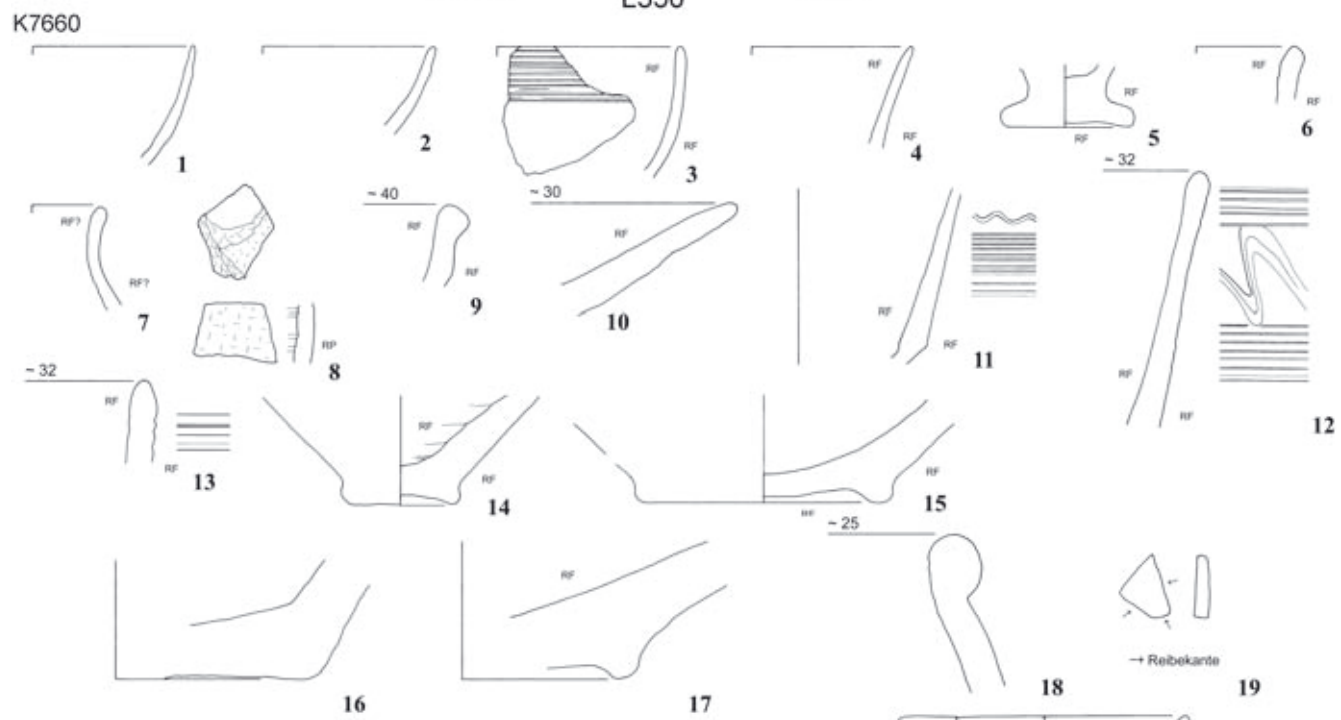

L352

Tafel 84

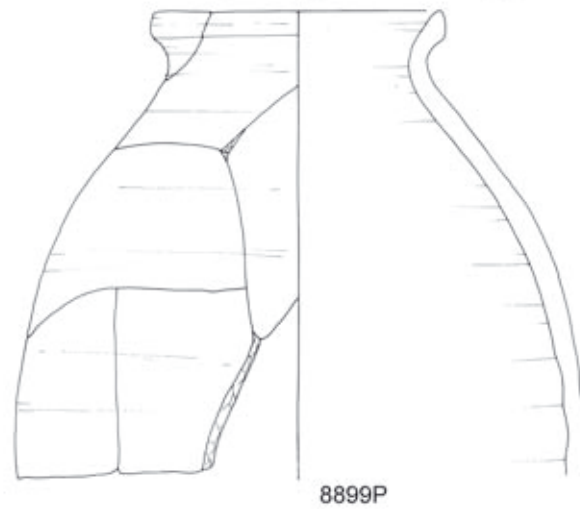

K7614

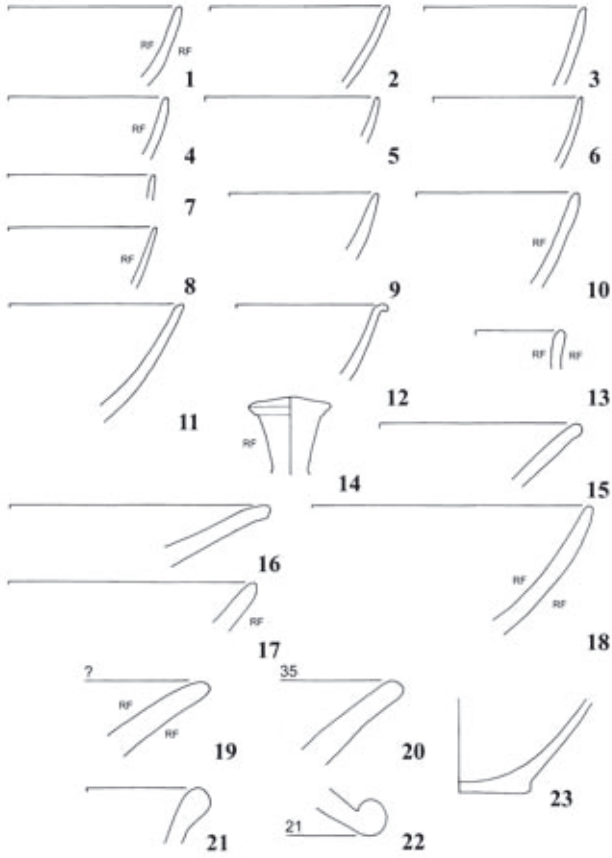

L355

K7589

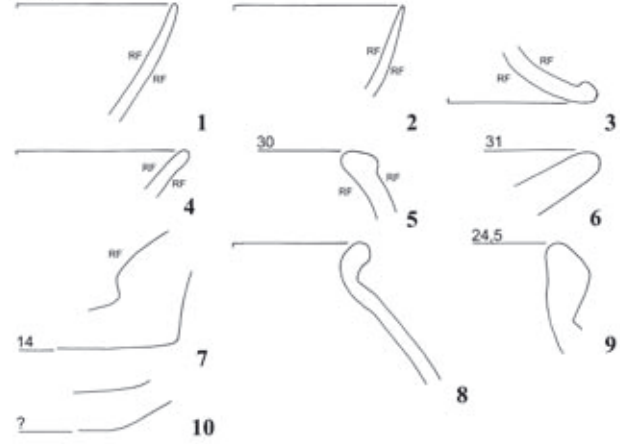

K7608

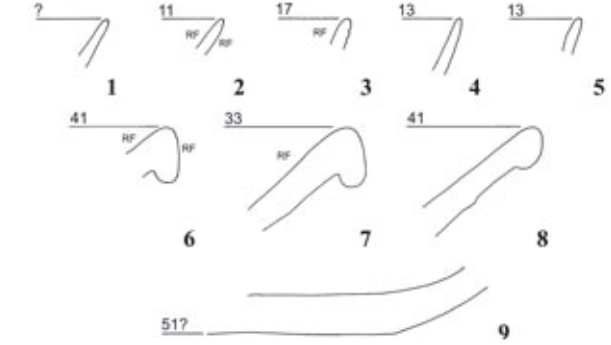

L356

K7585

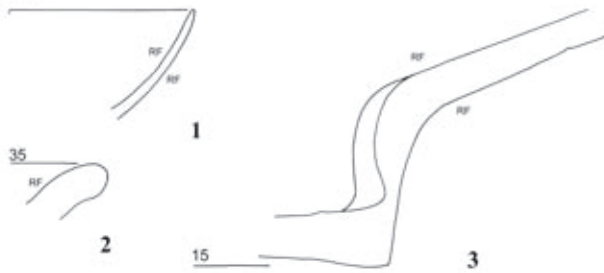

L357

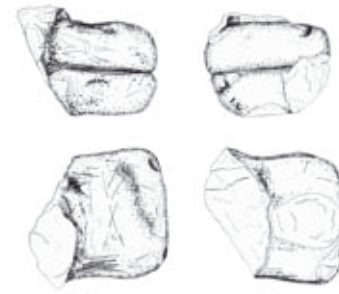

8949H



8900O

L358



8900L



8900M

L359

8900N

K7578

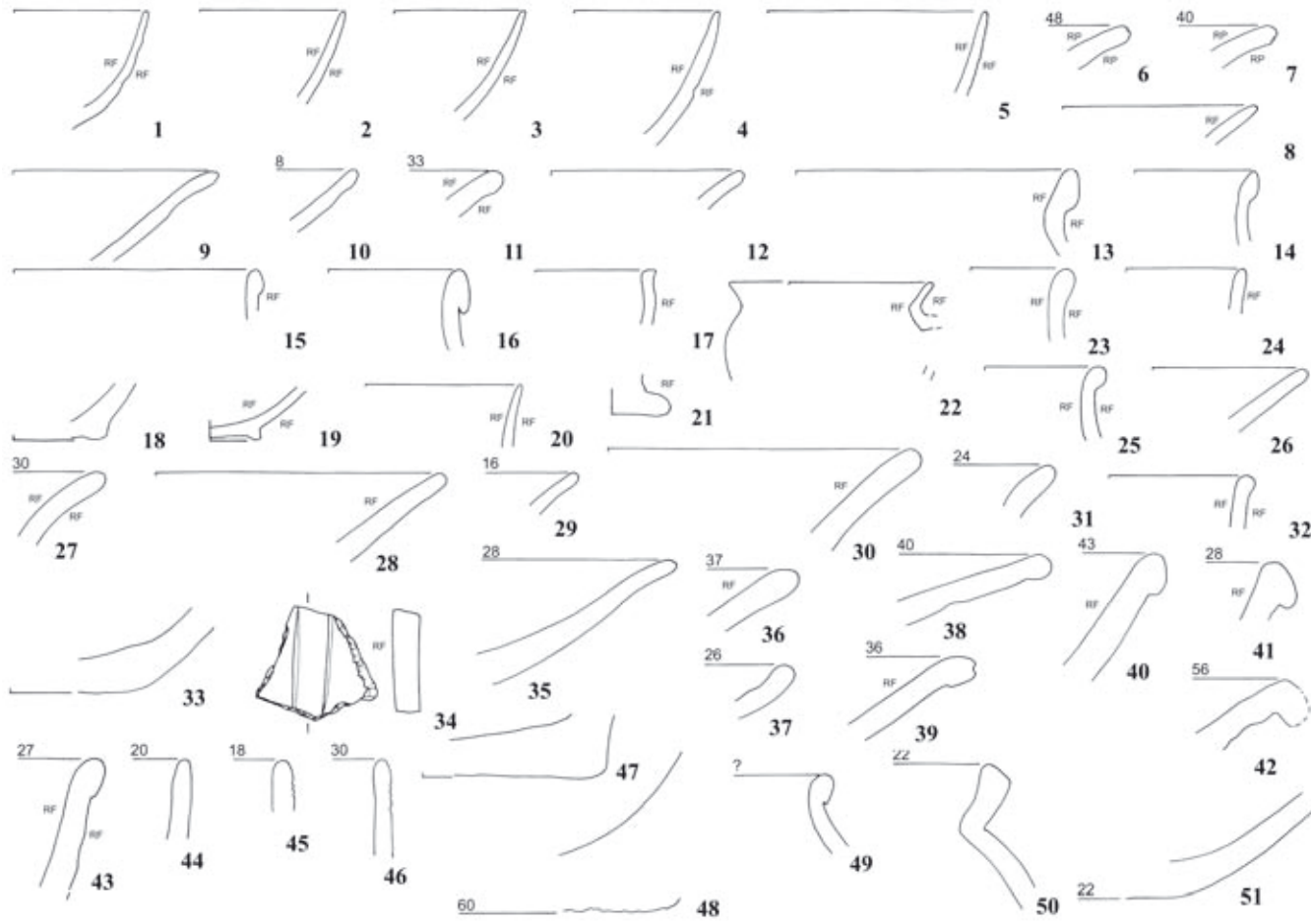

L360

K7580

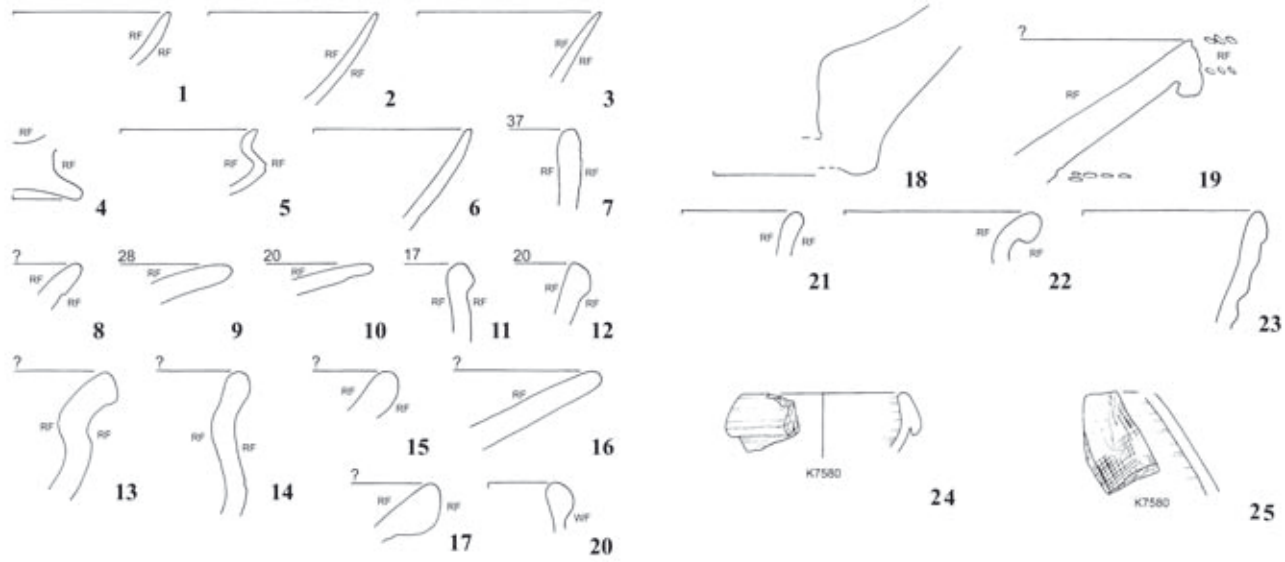

L361

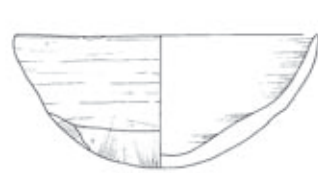

8889O



8890E

L362

K7582

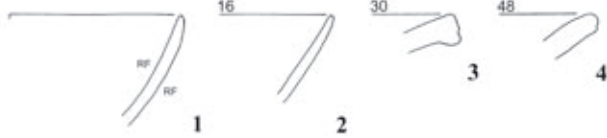

K7590

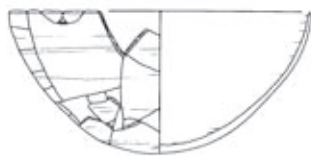
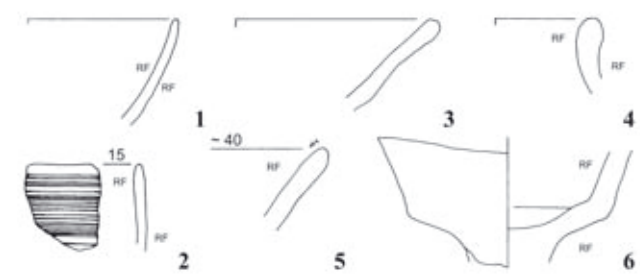

8888D



8889G



8889W

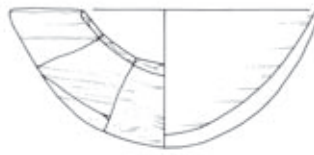

8890Y



8900J



8889L

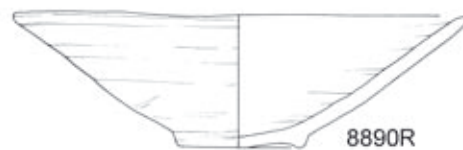

8890R



8949A



8889N

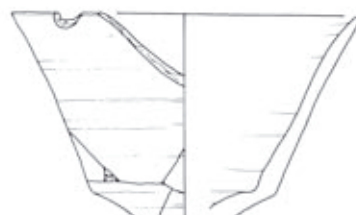

8890X



8976M

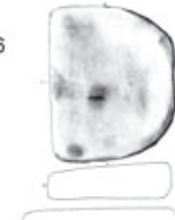

8976N

L363



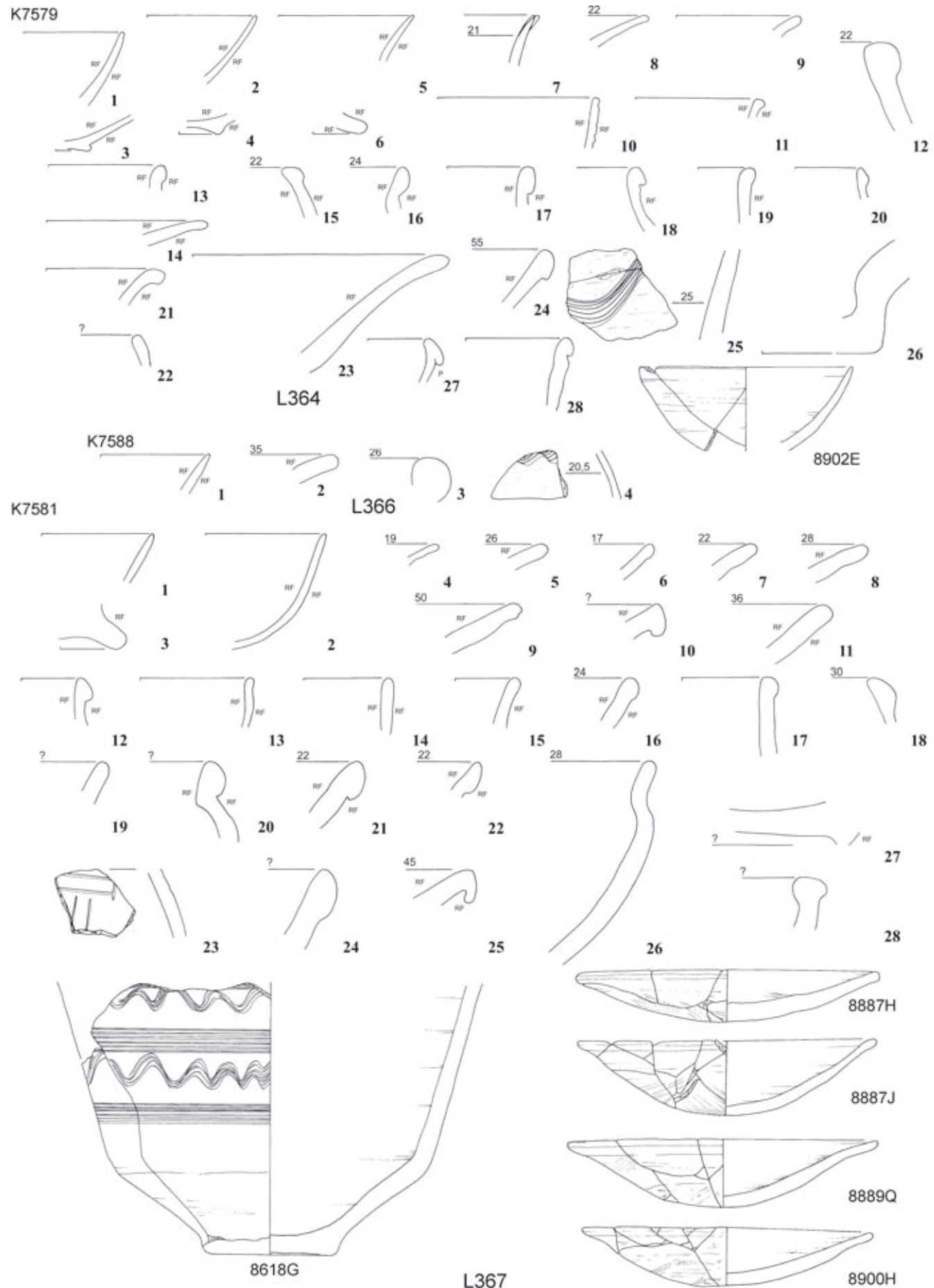

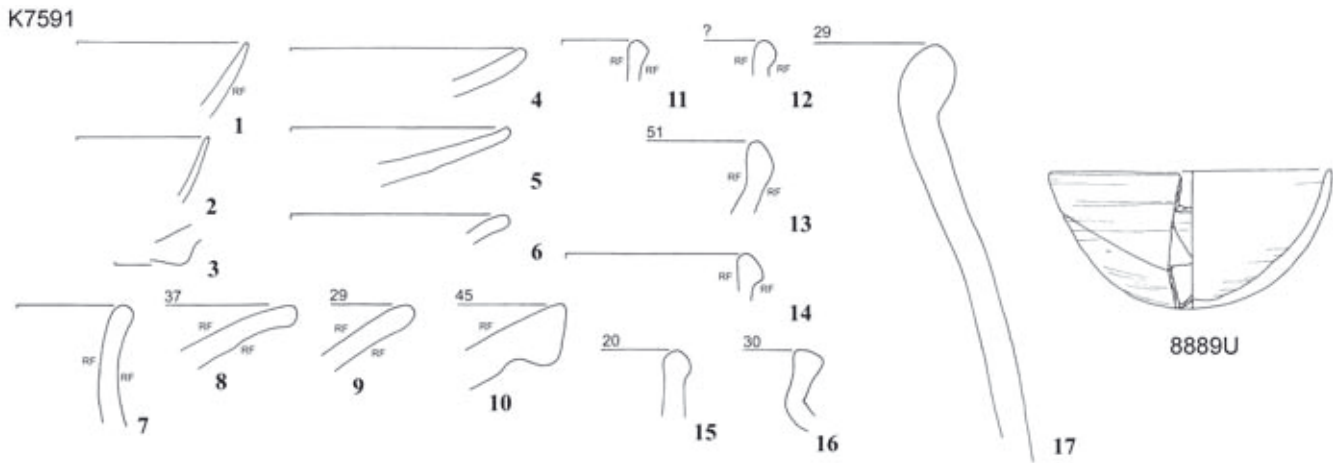

L368

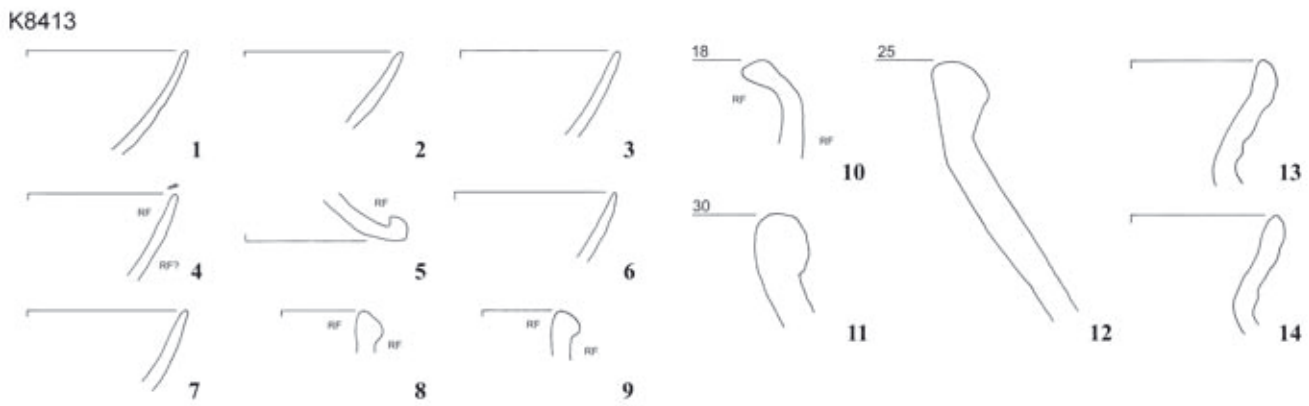

L371

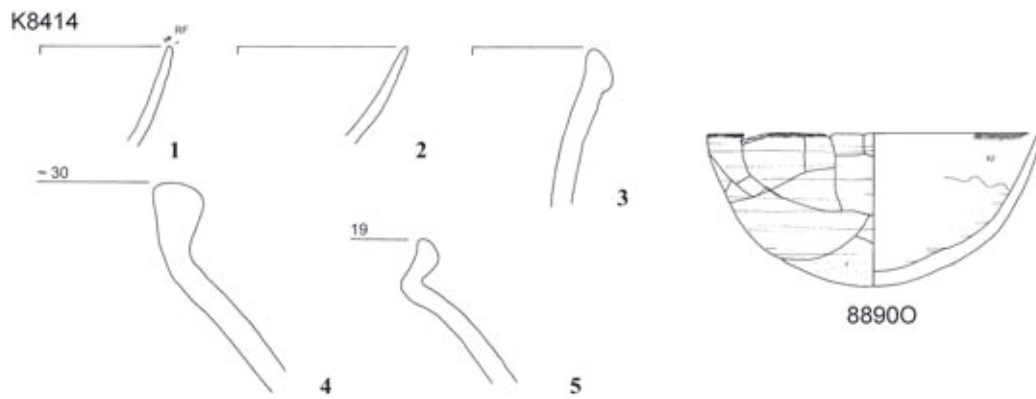

L373

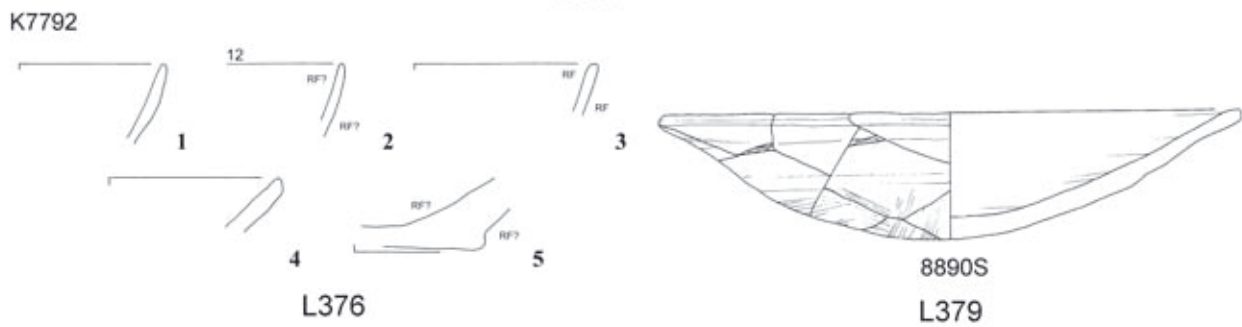

L376

8890S  
L379



K7345

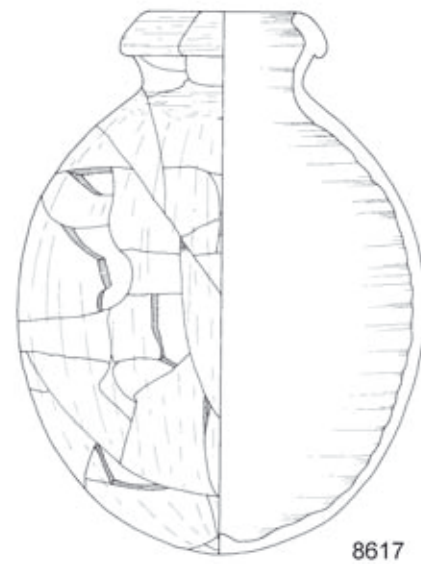
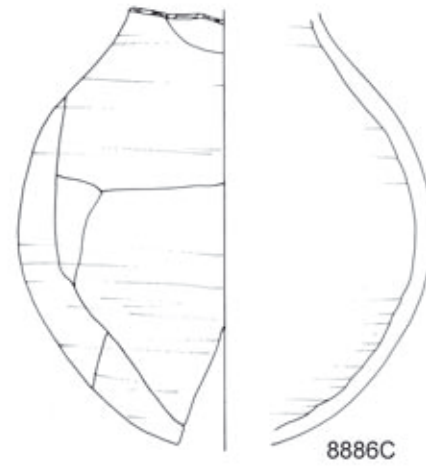
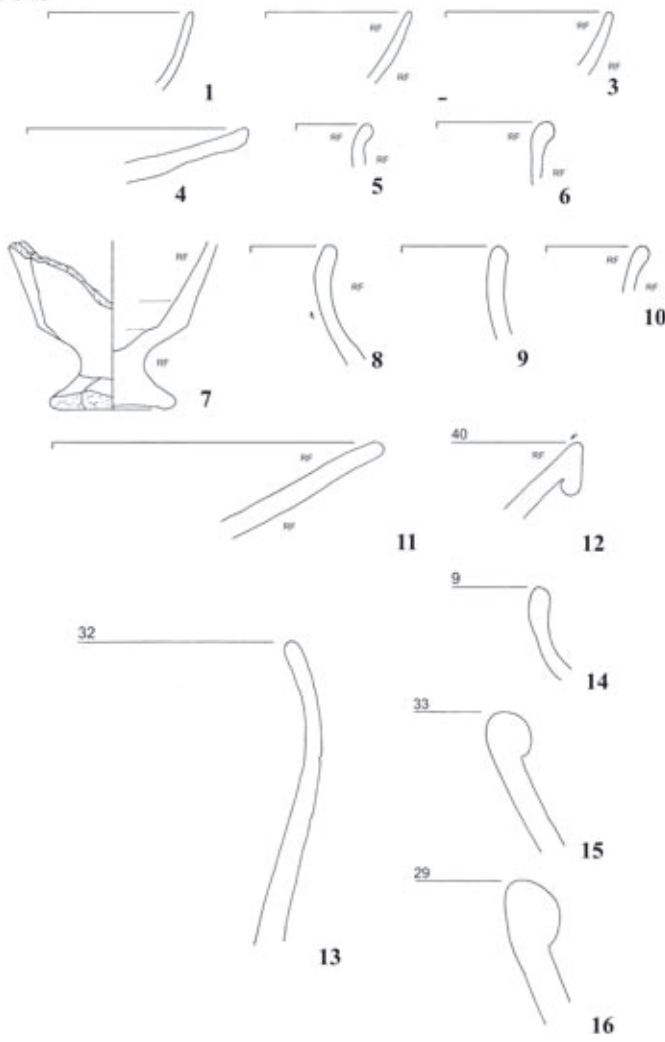

L380

K7343

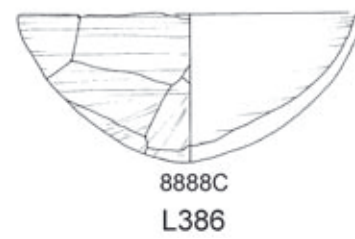
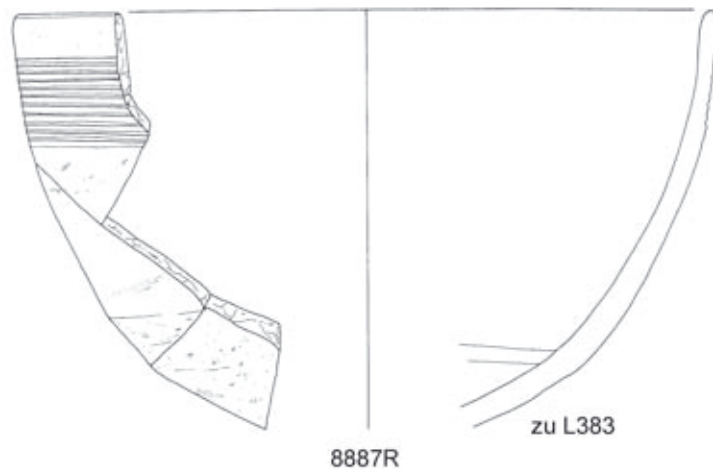
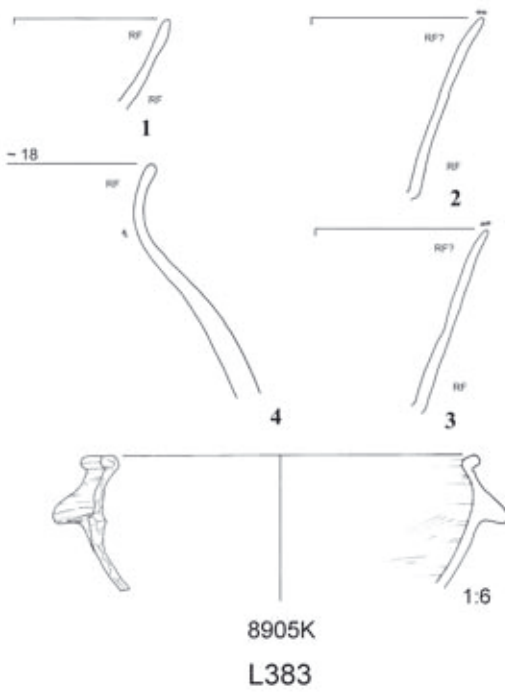

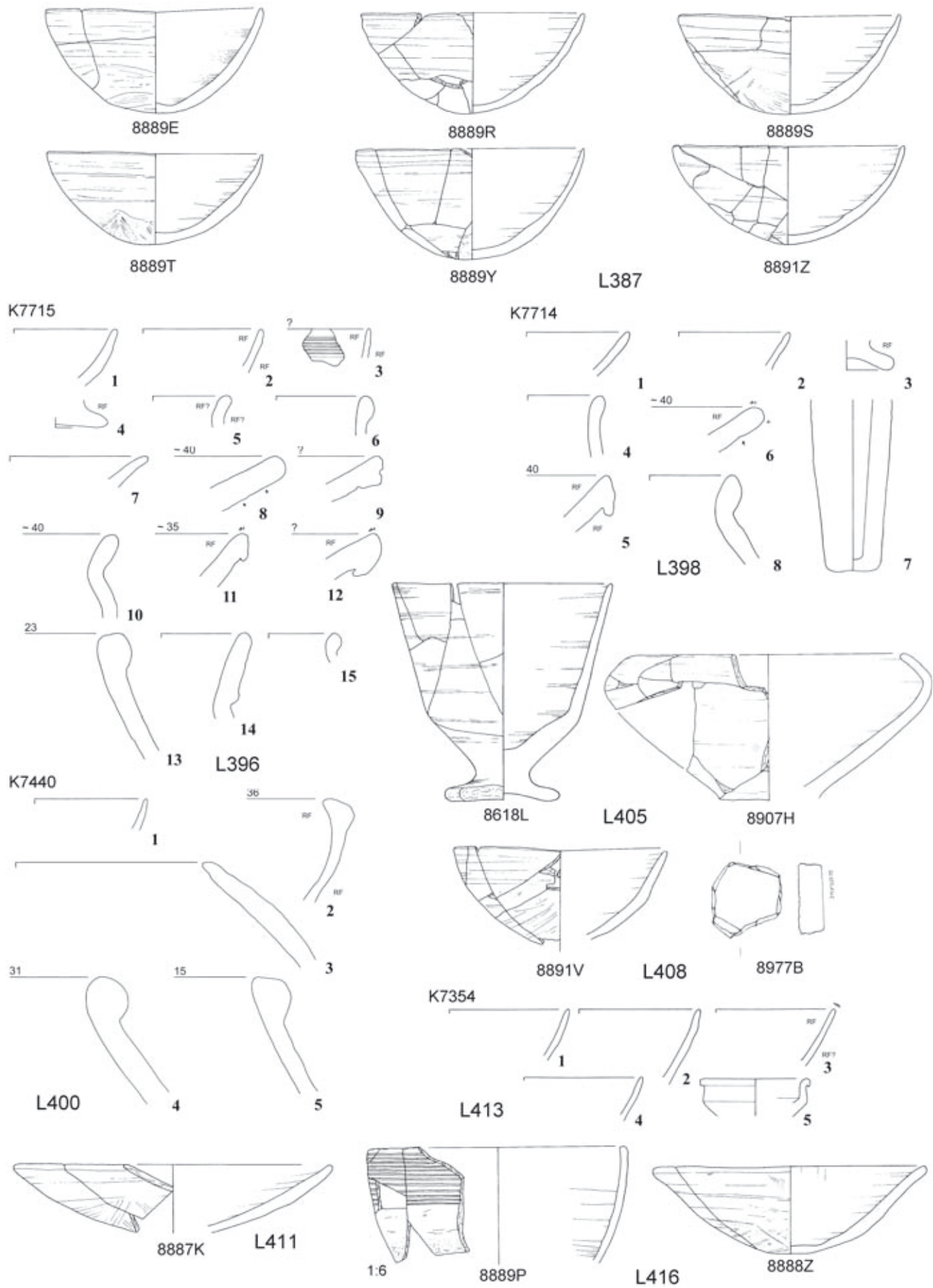

Tafel 91

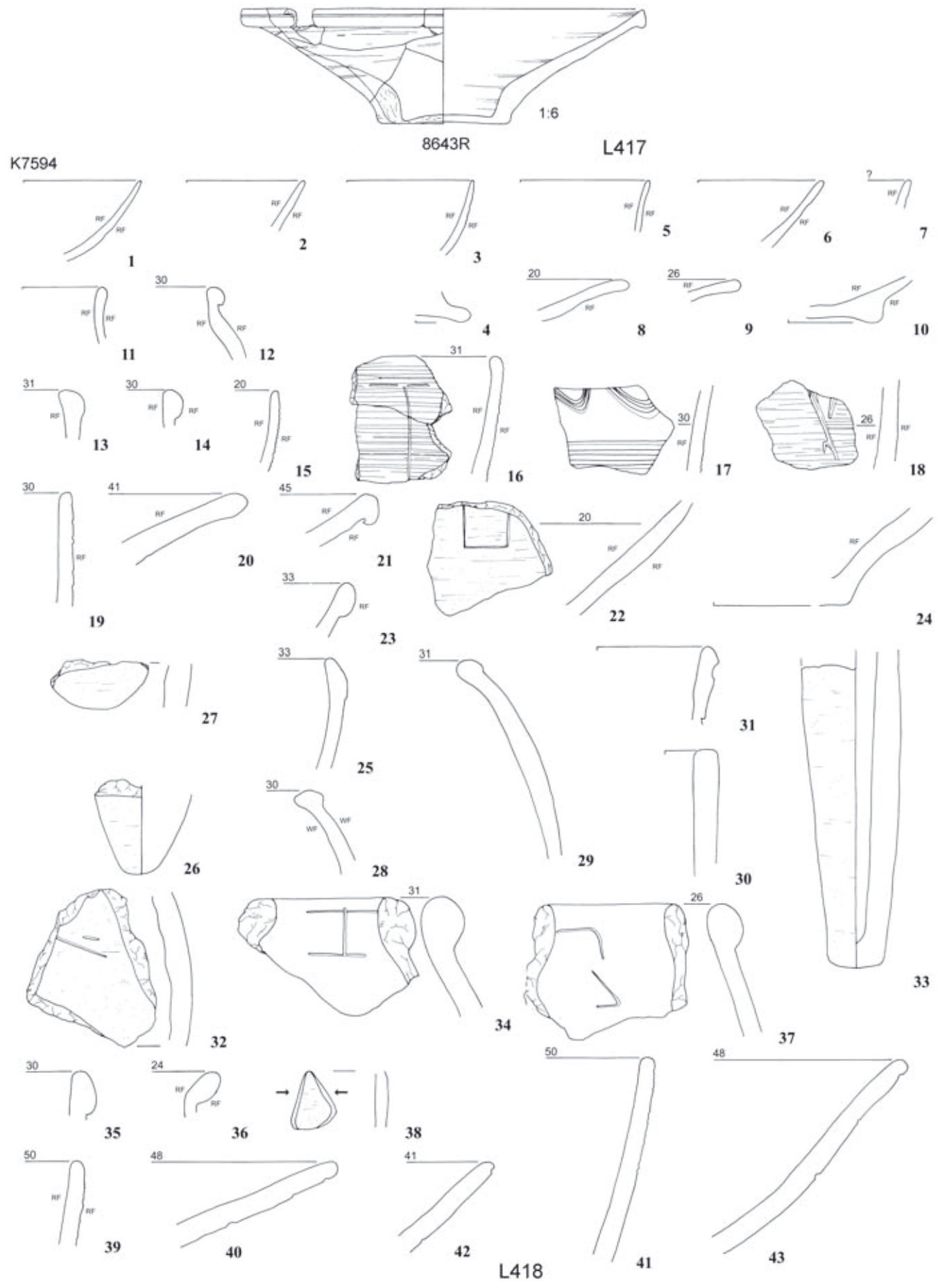

K7595

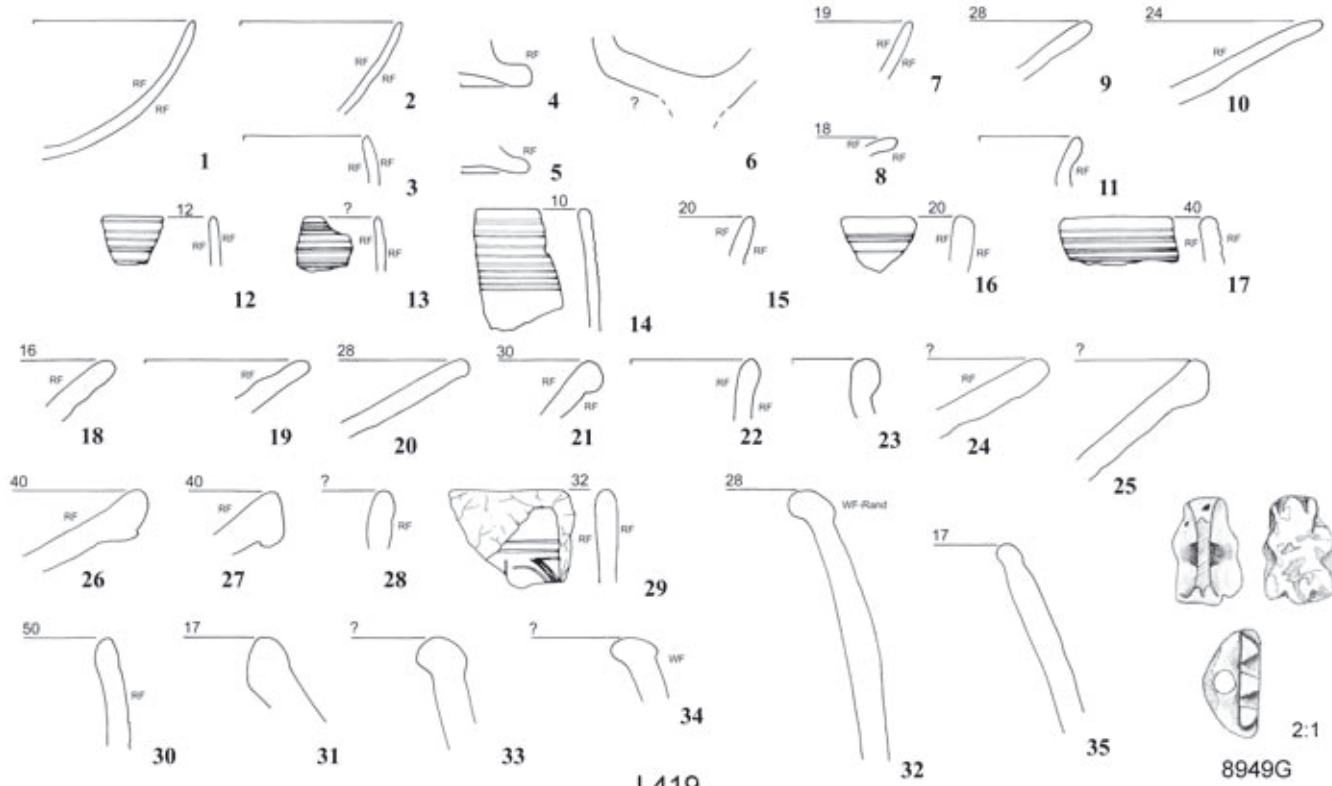

L419

K7600

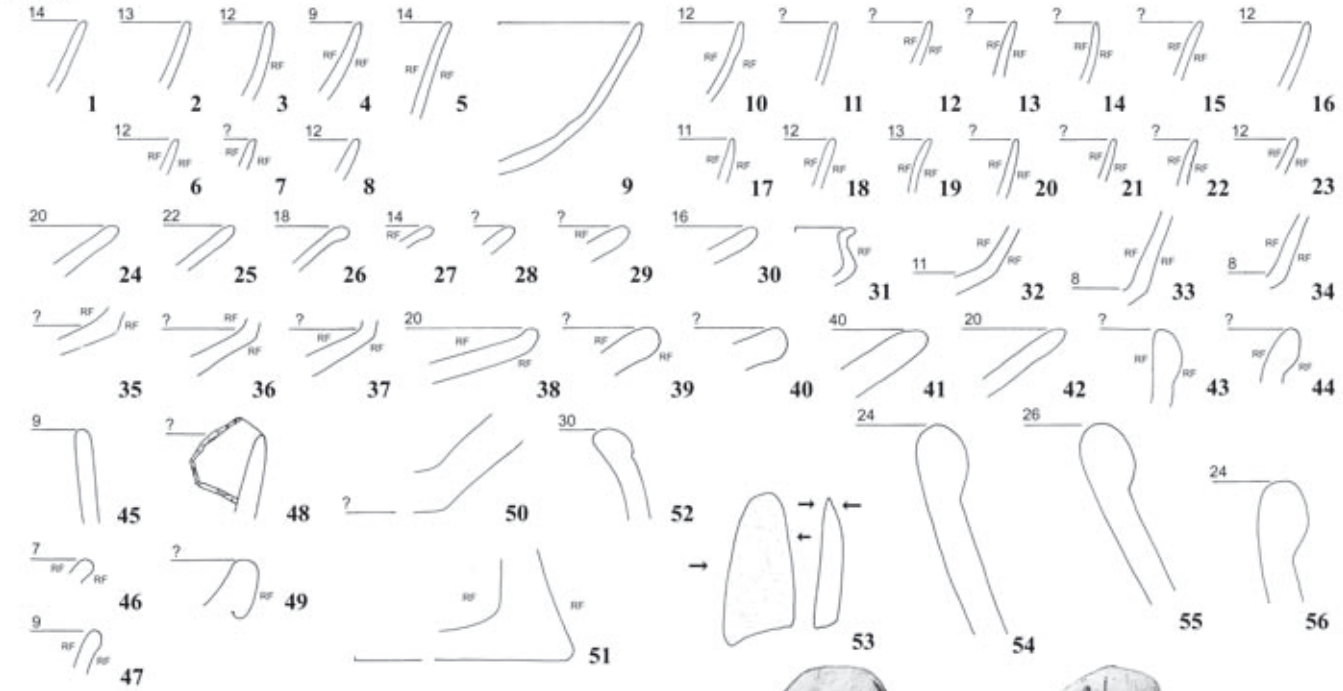

8899K



L420



8949K

1:1



K7601

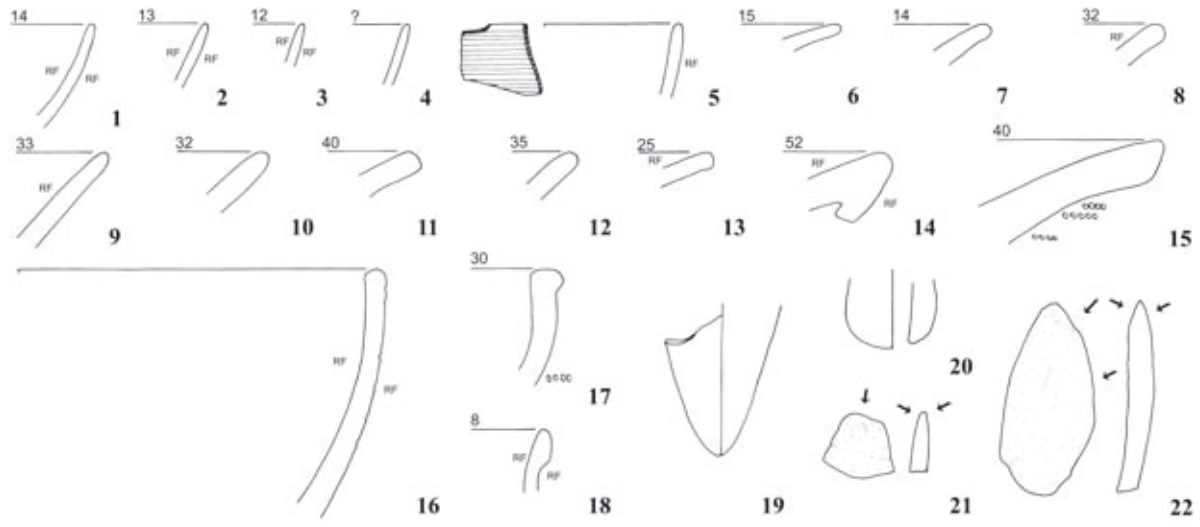

K7603

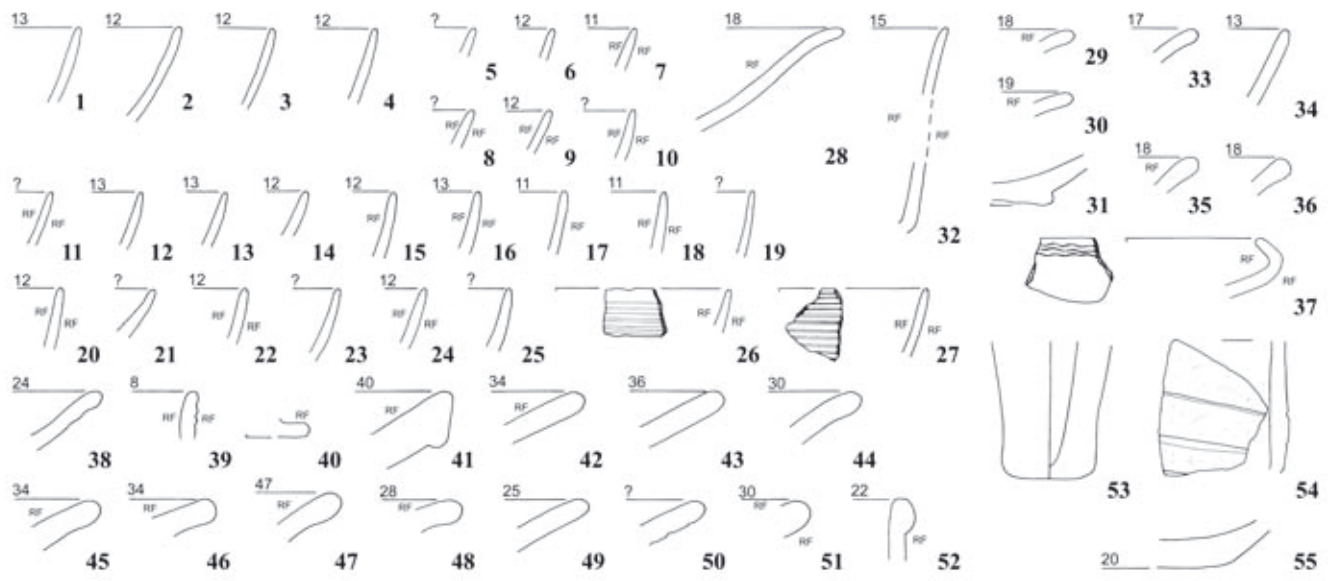

K7610

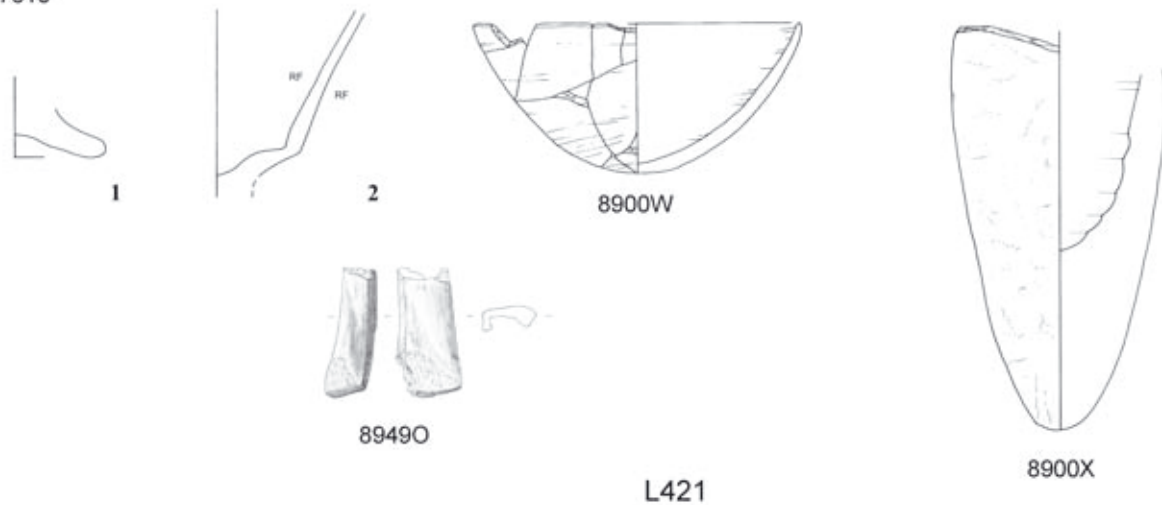

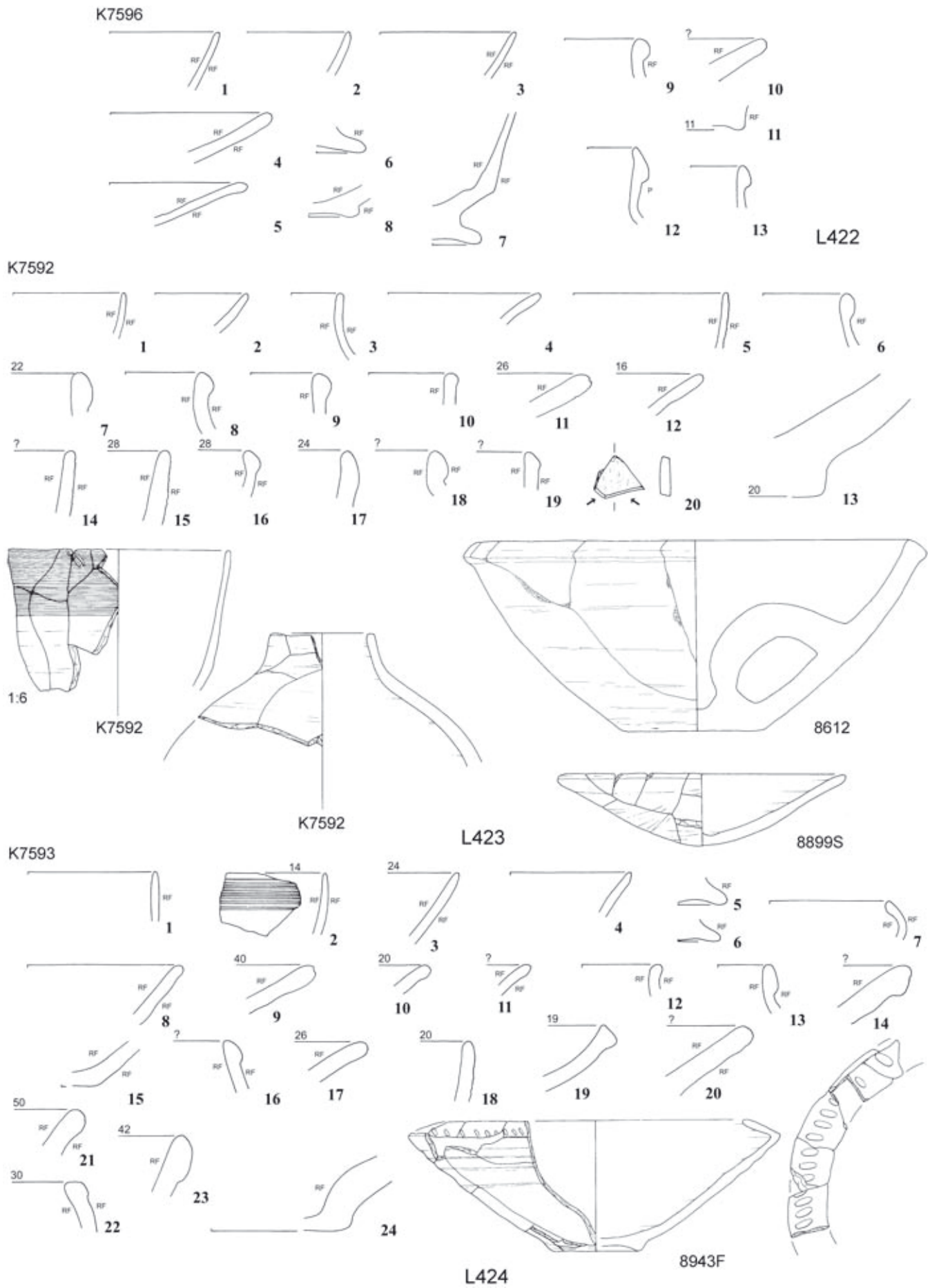

Tafel 95

K7455

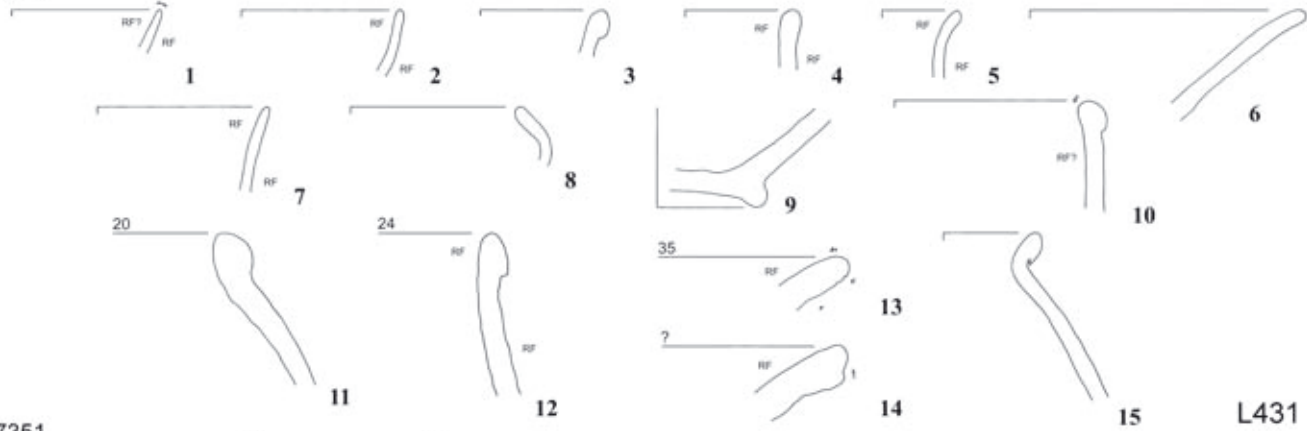

K7351

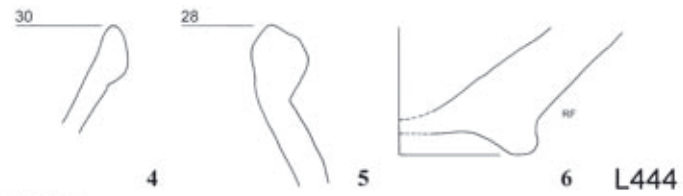
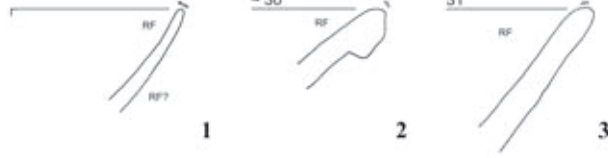

K8416

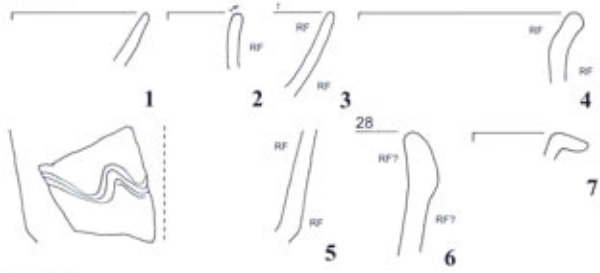

K8419

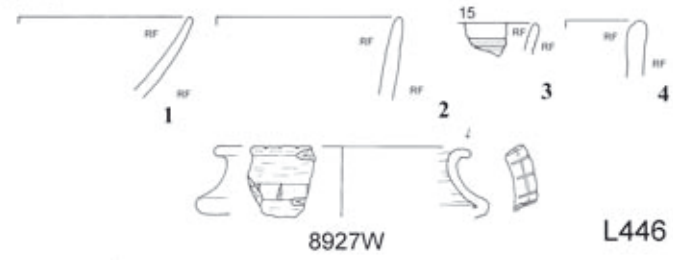

K7806

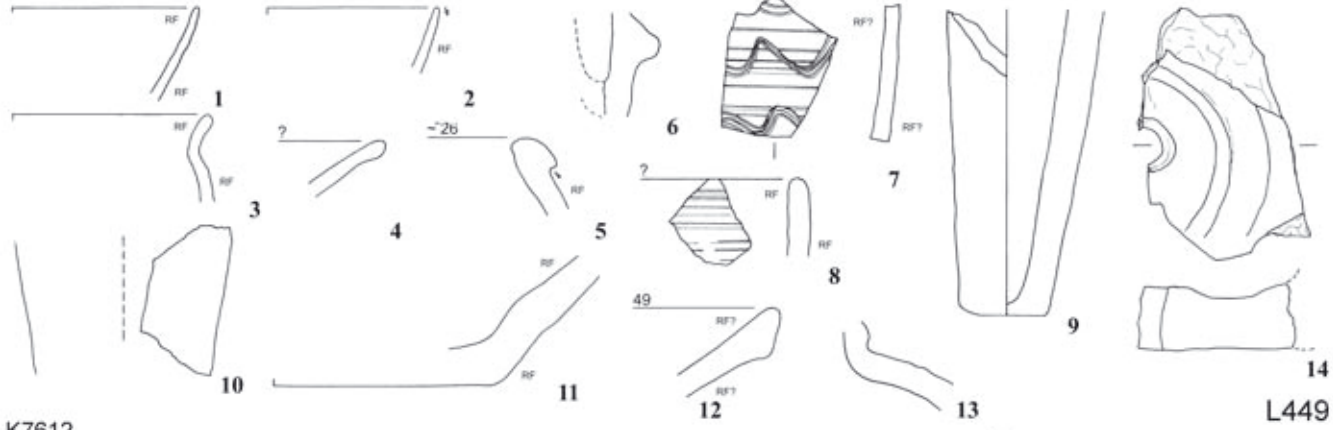

K7612

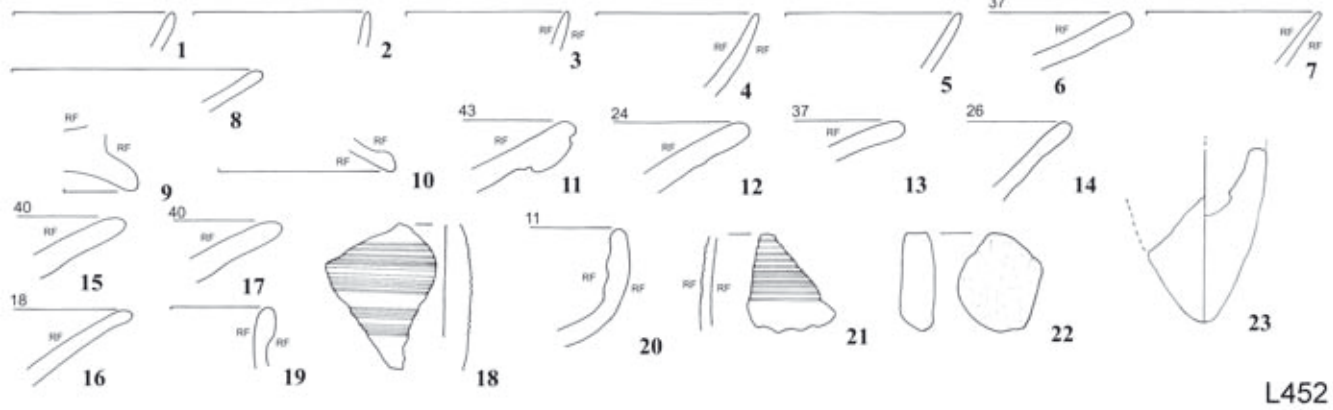



K7604

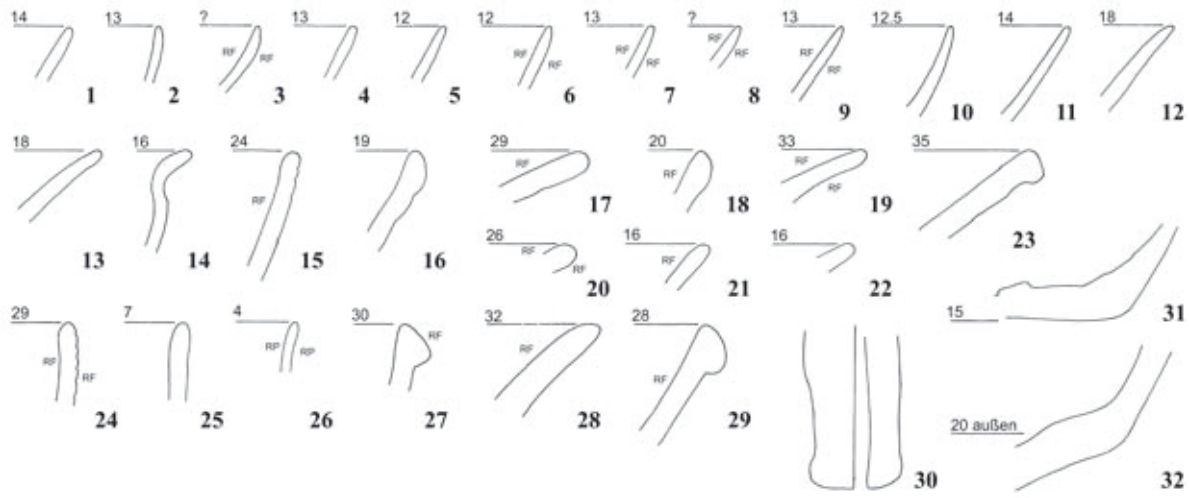

8899J



8889Z

L454

K7605

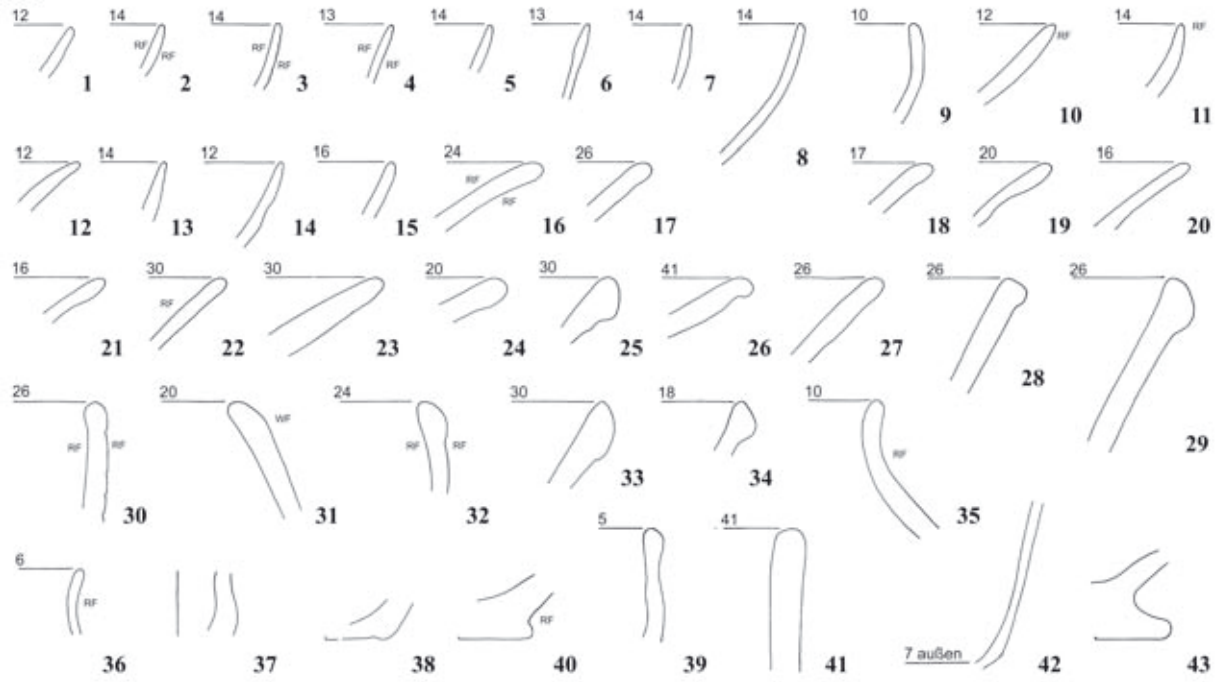

L455

K7816

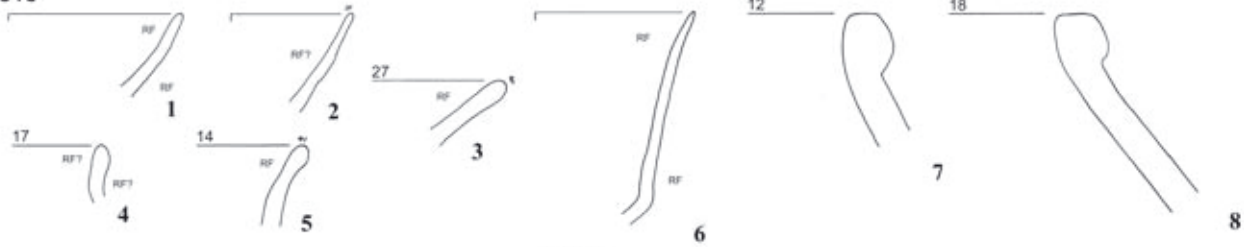

L457

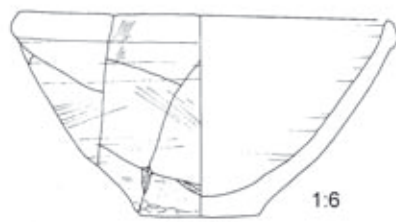

8898M  
L468

K7364

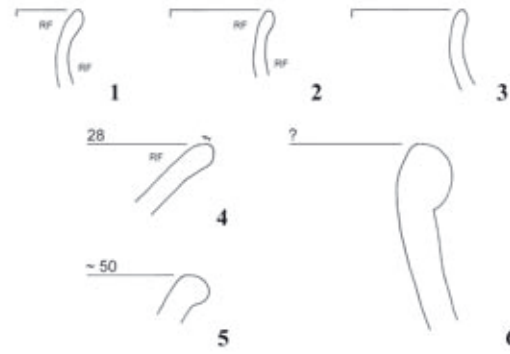

L469

K7524

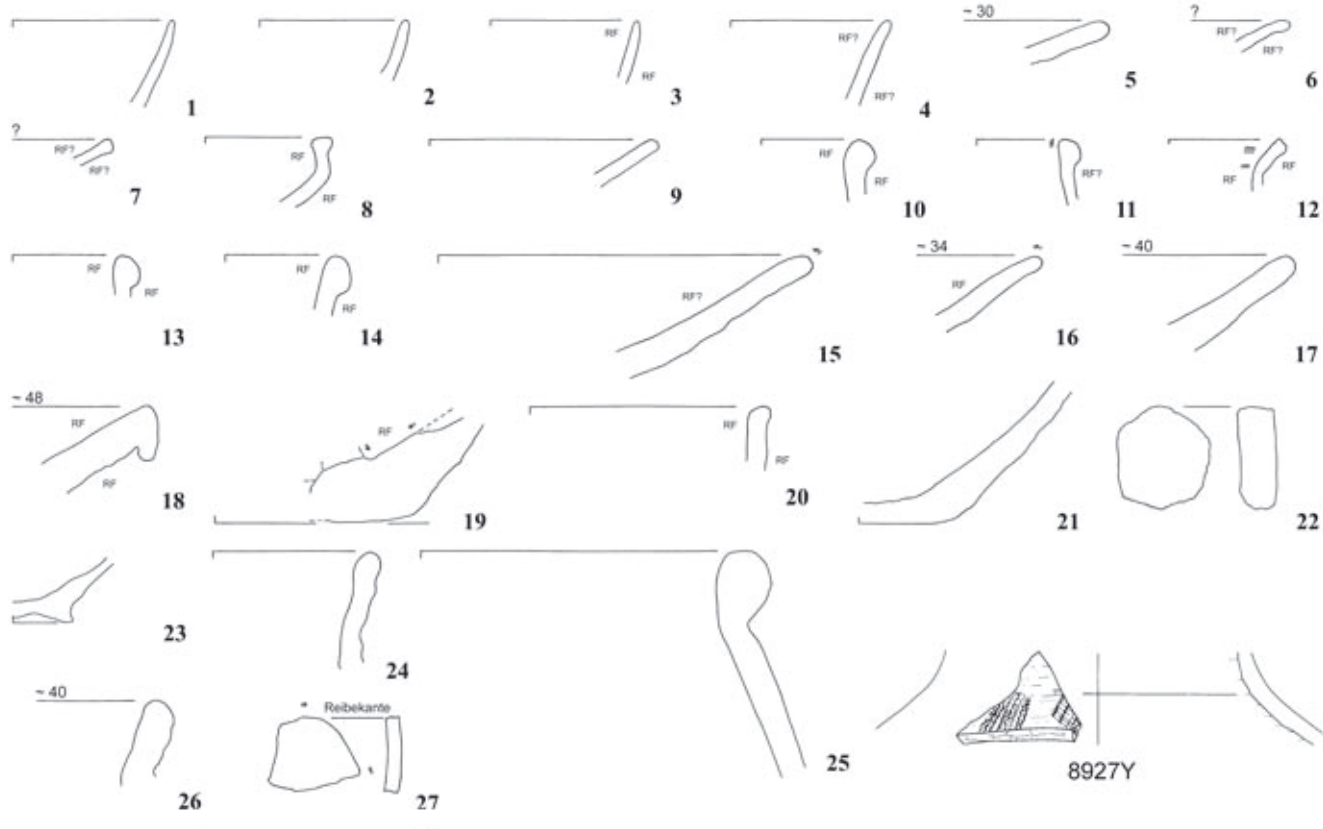

8927Y

K7816

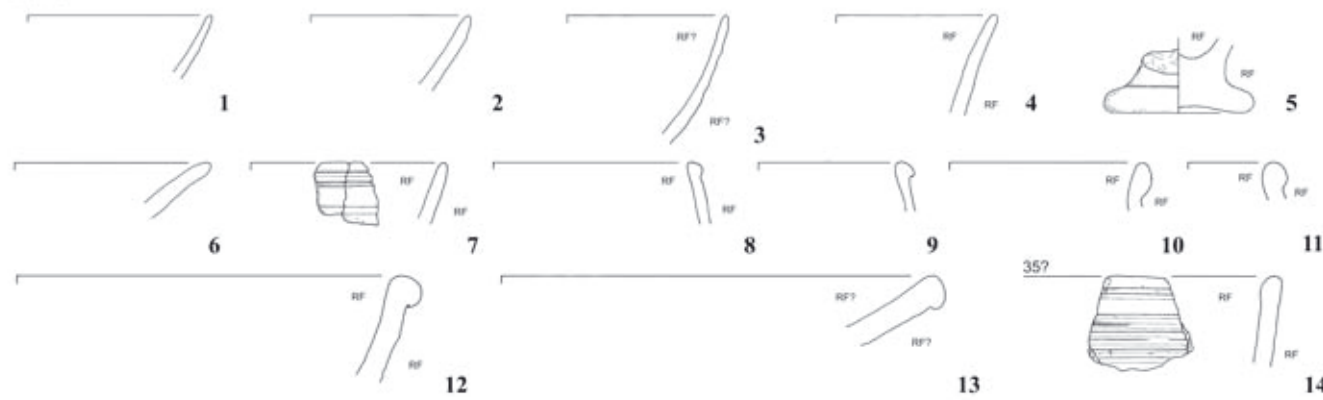

L479

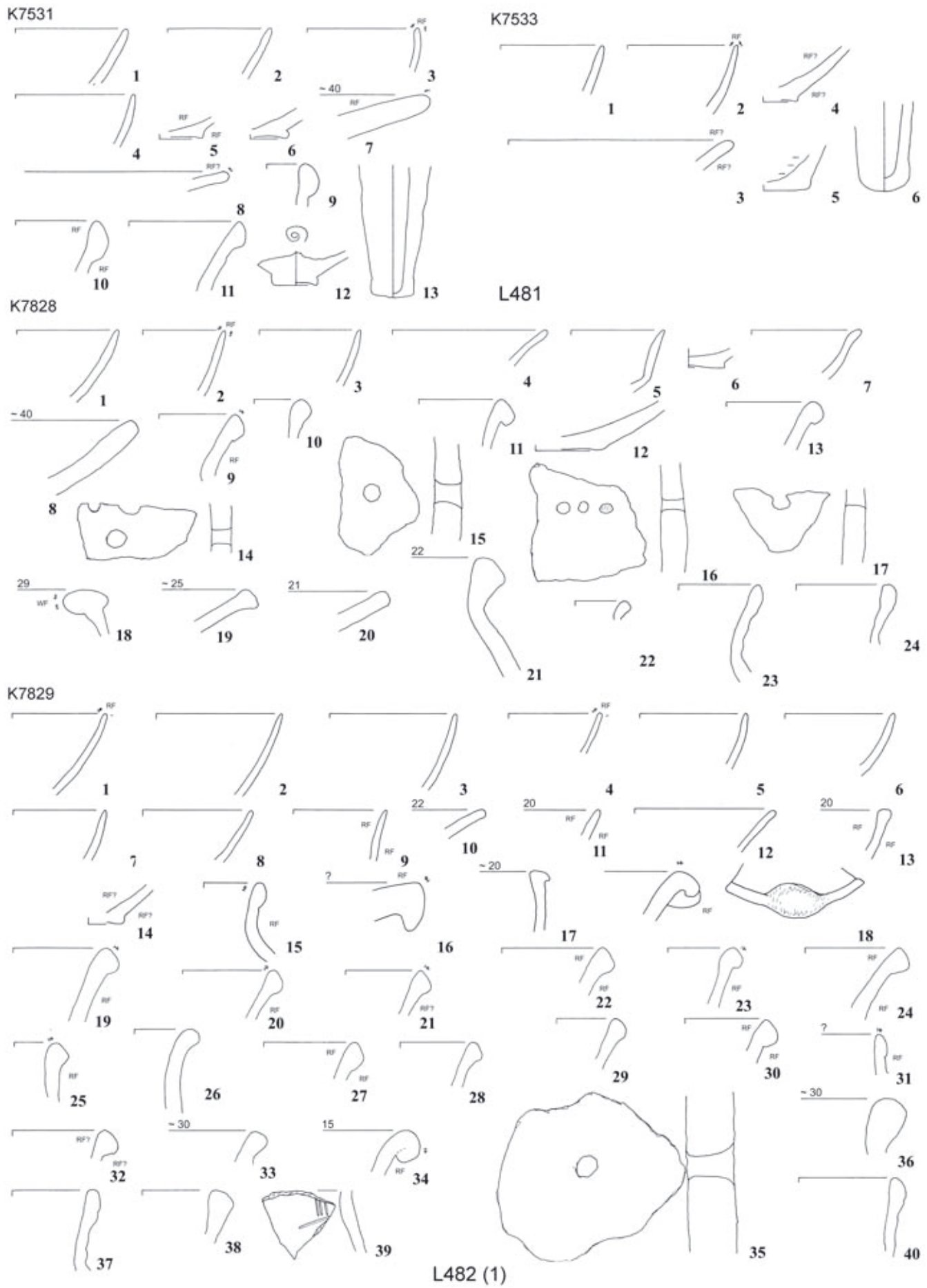

Tafel 99

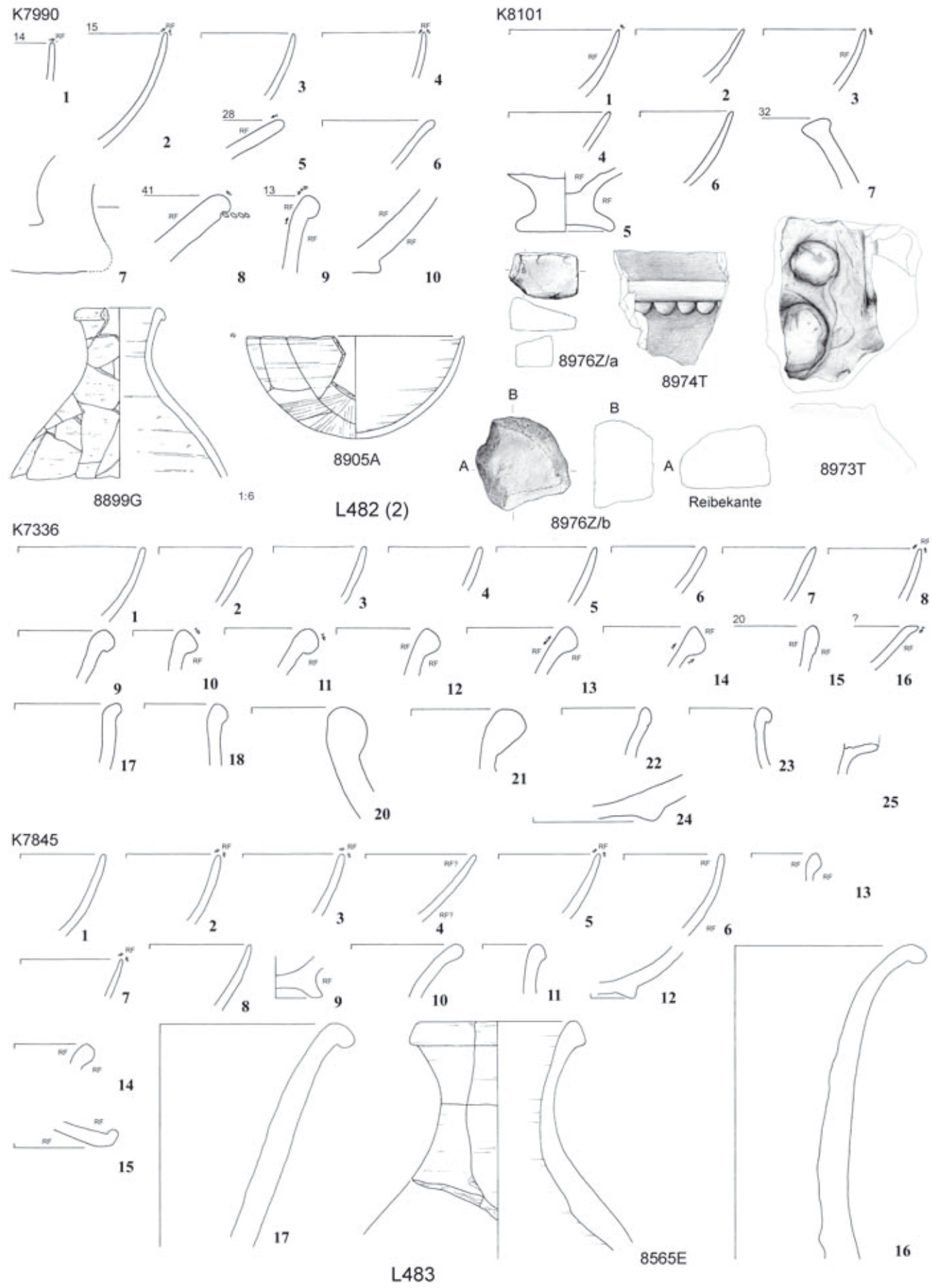

K8104

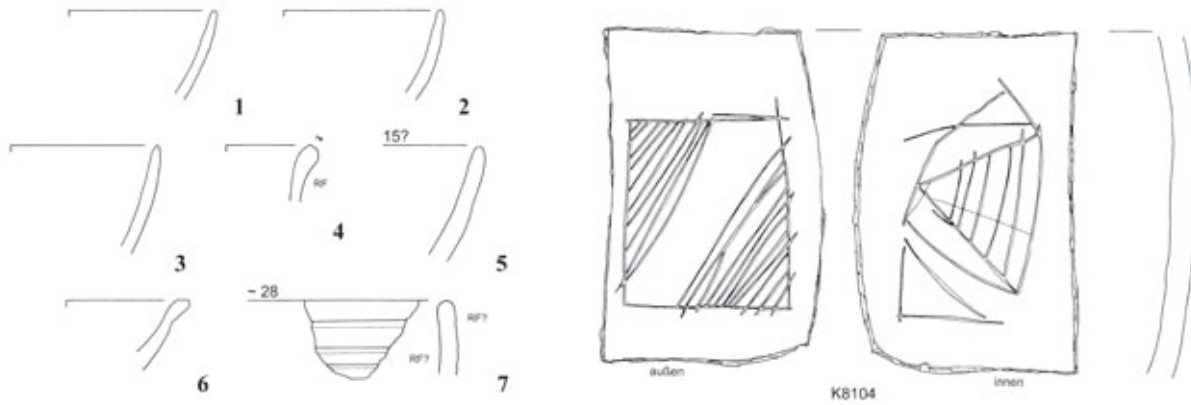

L484

K7846

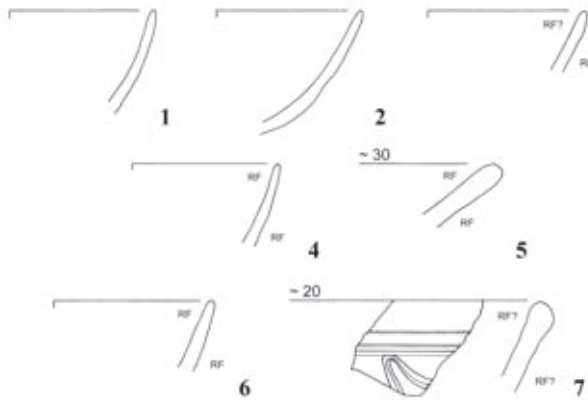

L485/486/488/489/490

K7843

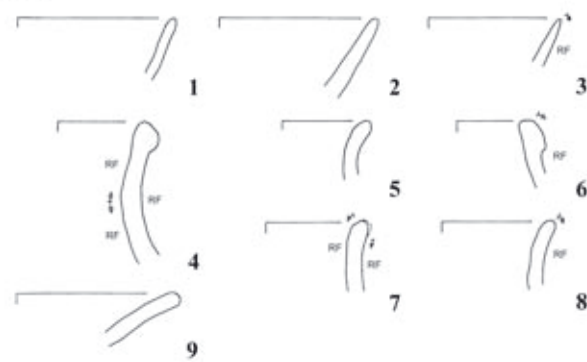

L488

(L487 nach L489!)

K7841

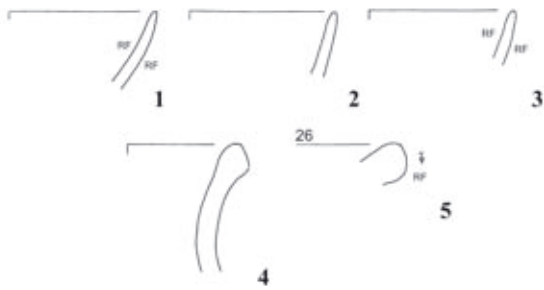

K7844

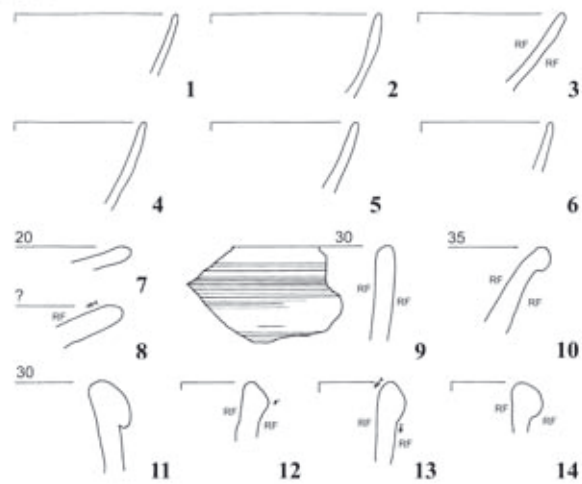

L489



K8110

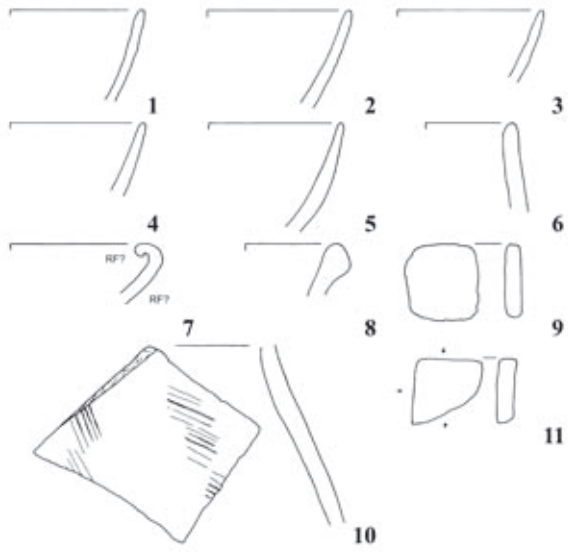

K8114

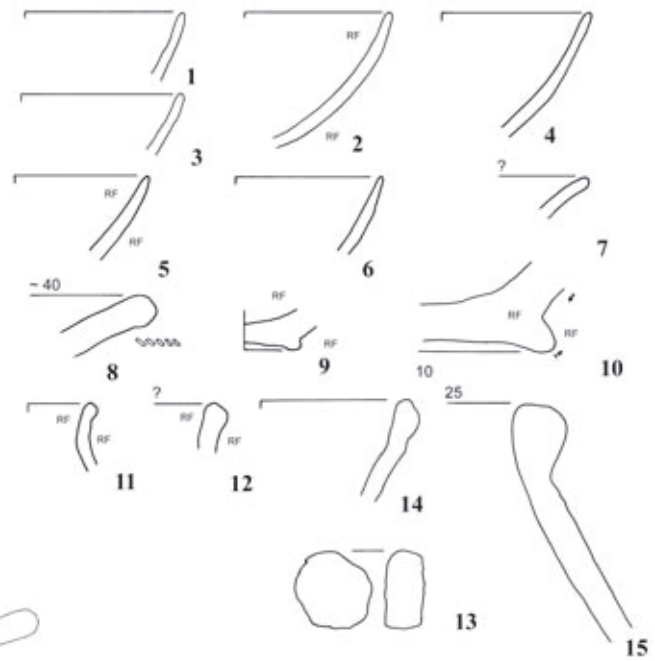

K7849

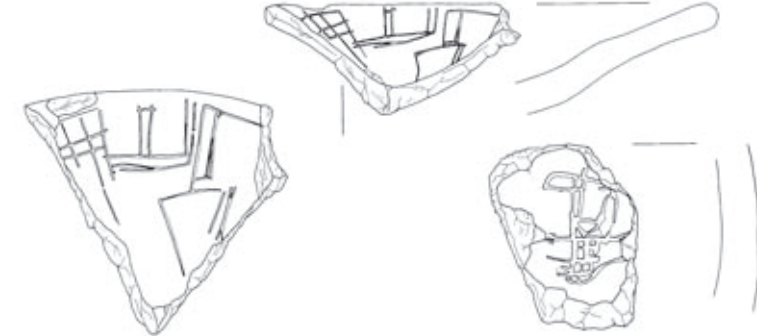

8898N

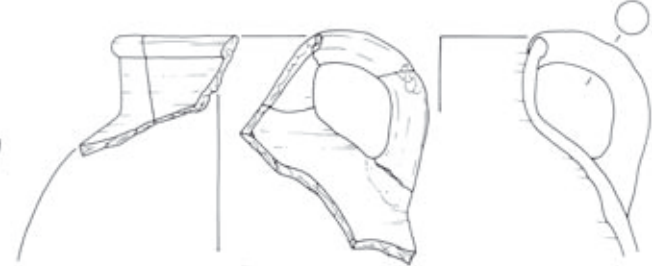

8885L



8885P

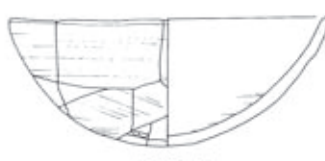

8885M



8885Q

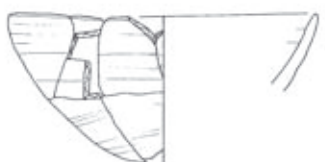

8885N



8885R

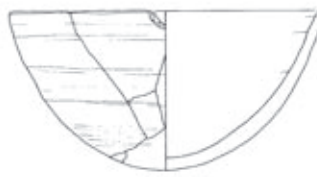

8885O

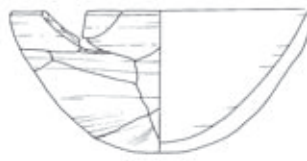

8913H



8907S



8907Q

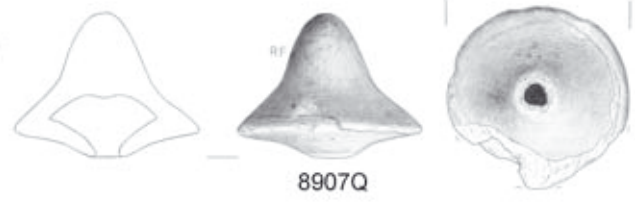

8976Q



L487



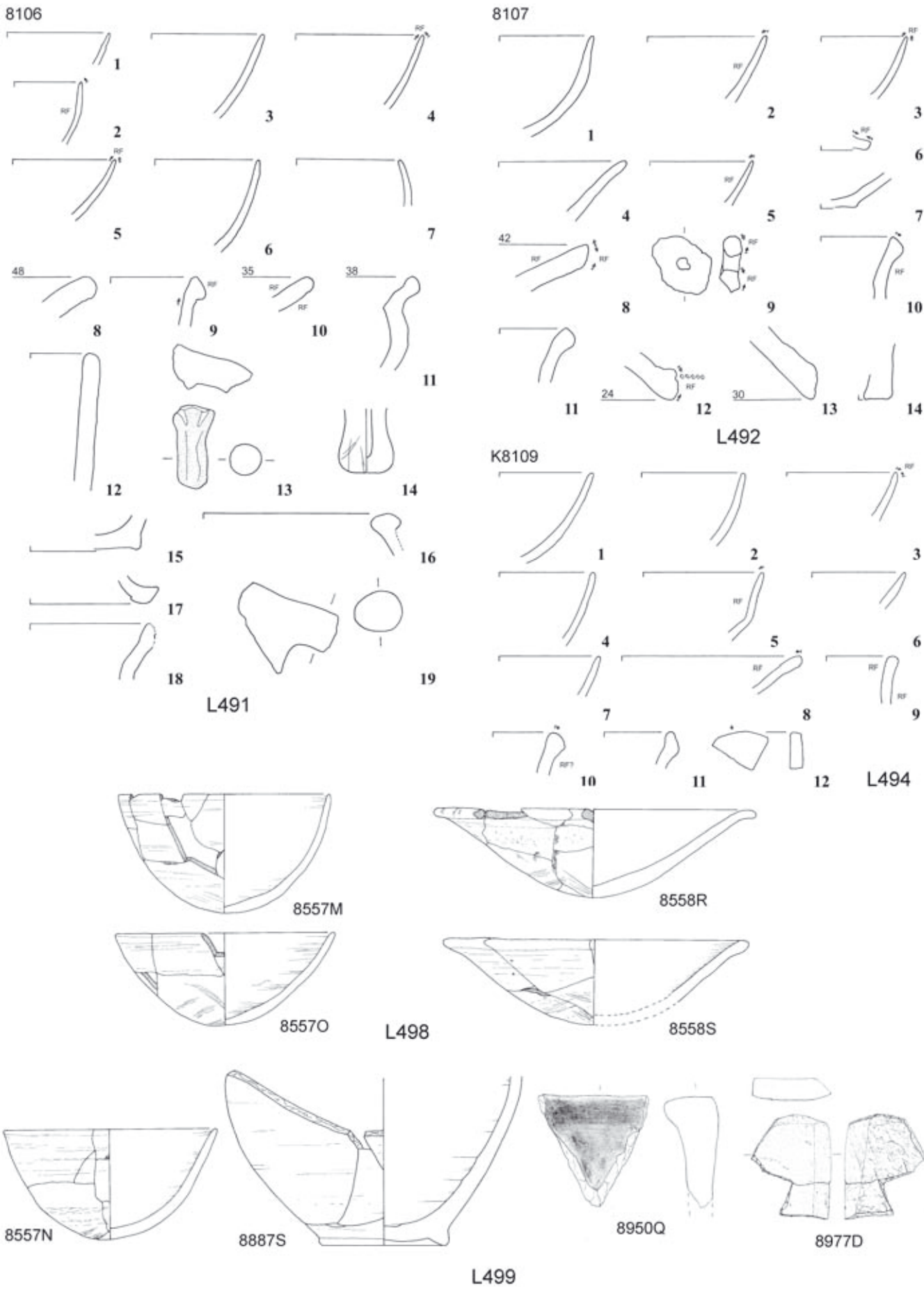

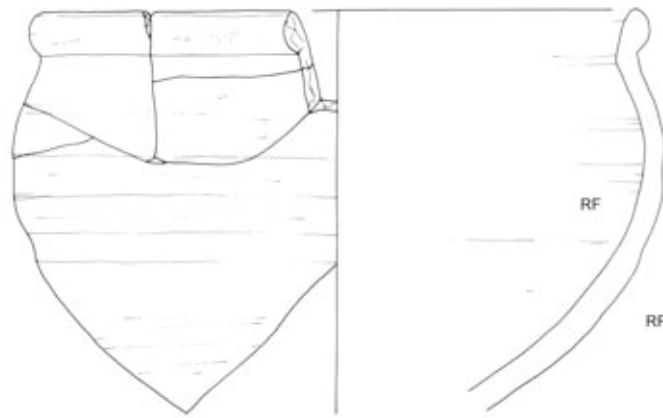

8899U  
L502

K7865

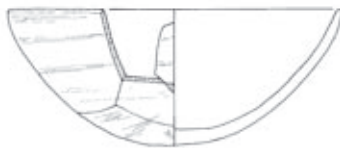
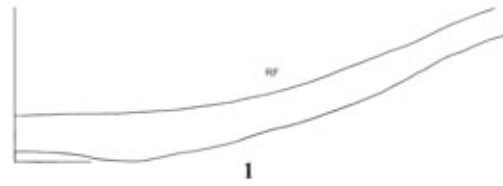

8557P



8557S

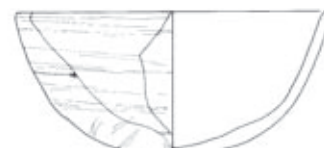

8557U



8557Y



8557Z



8558E

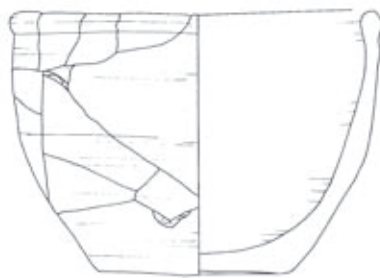

8886M

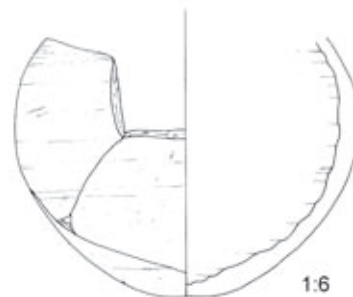

8897V



8898J

L504

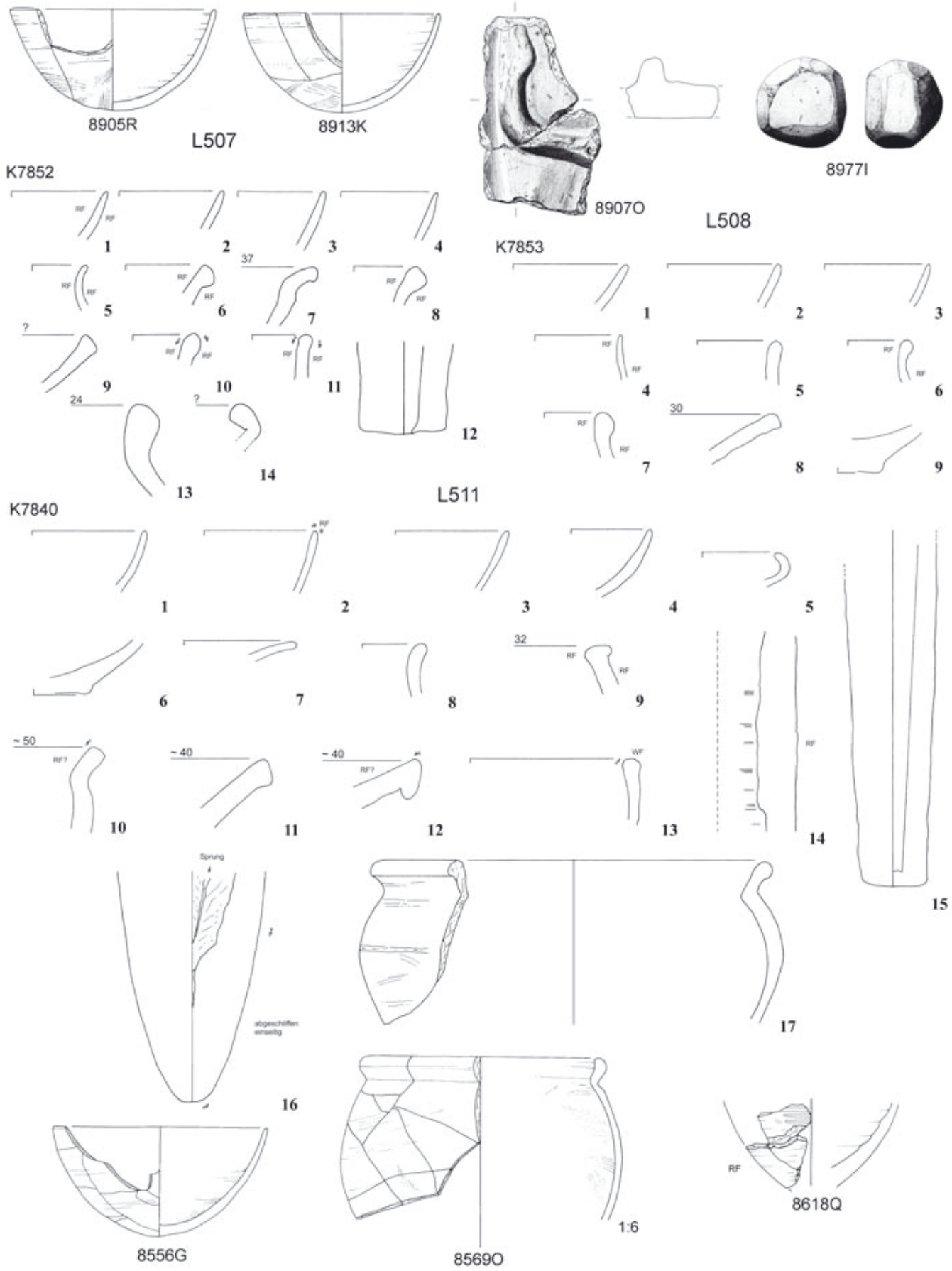

K7835

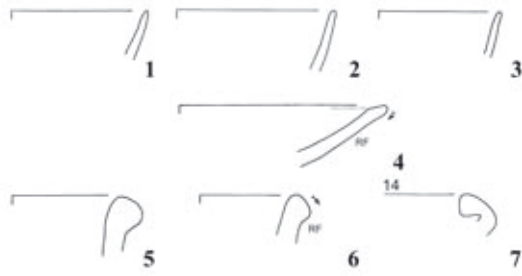

L513

K7837

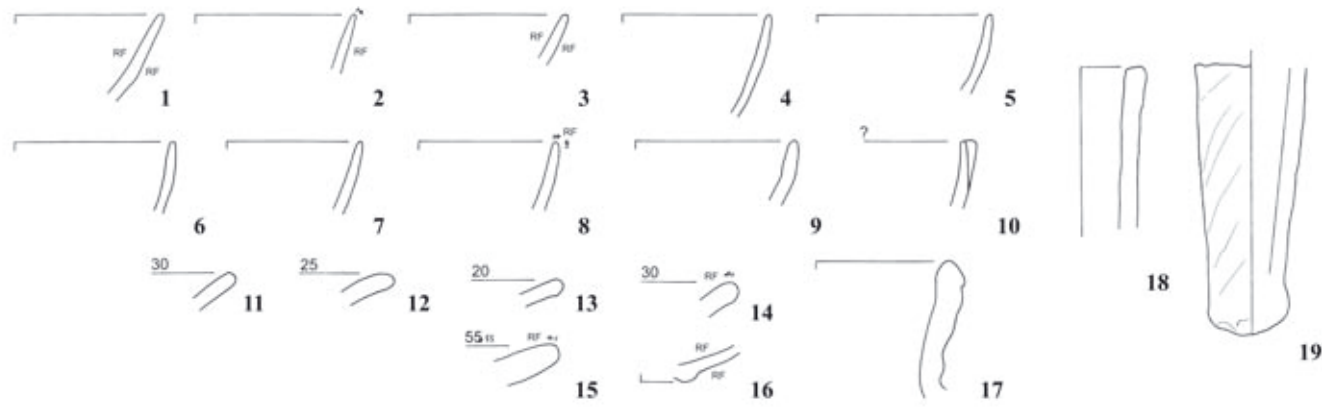

L514

K7826

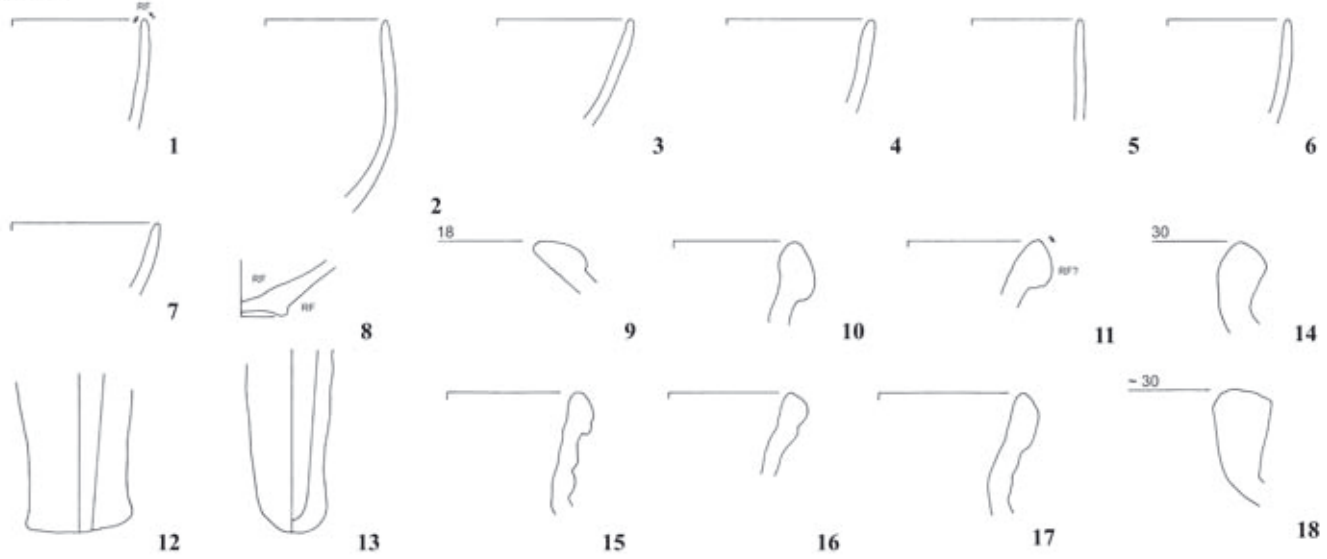

K7830

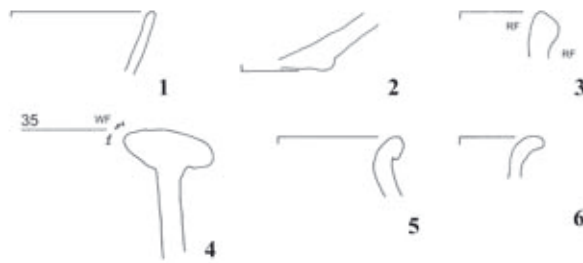

L516

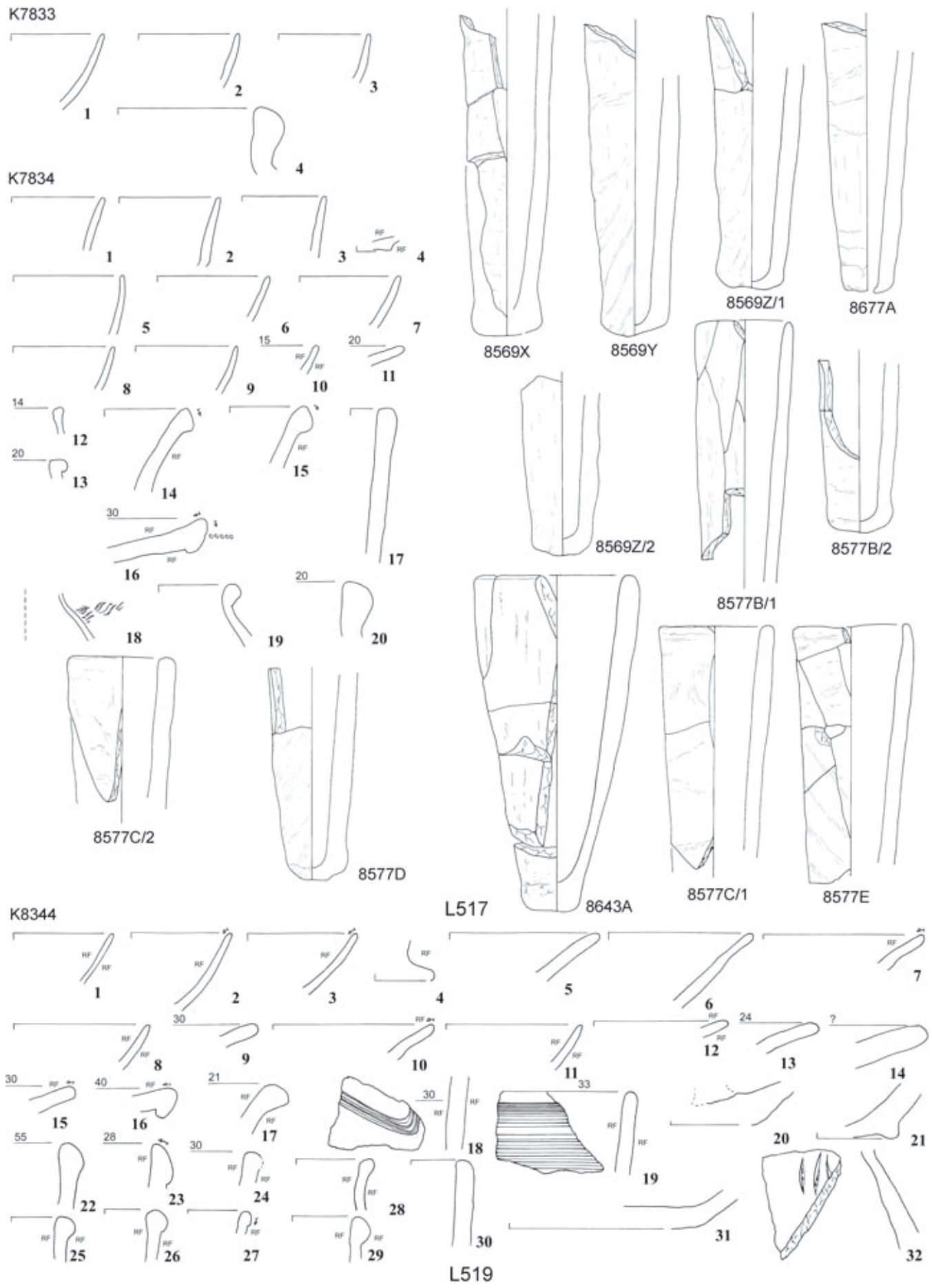

Tafel 107



K7920

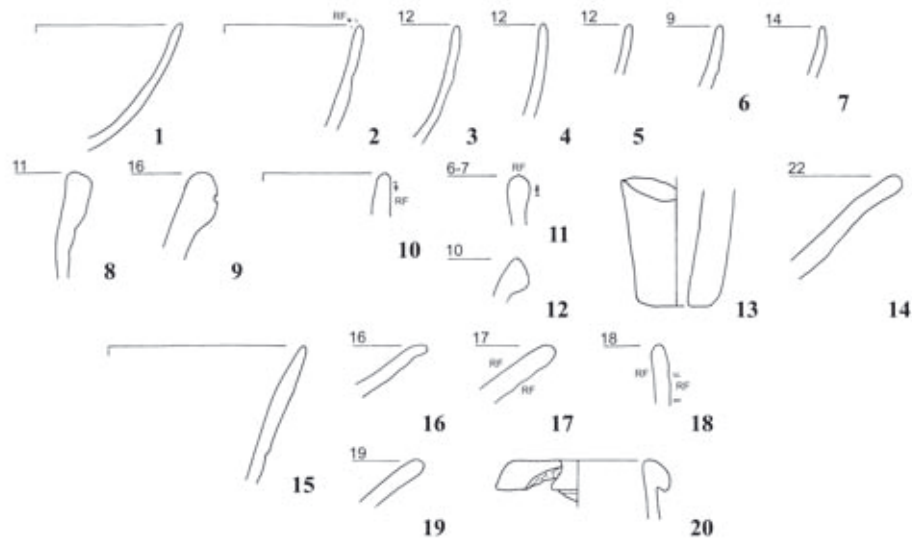

K7921

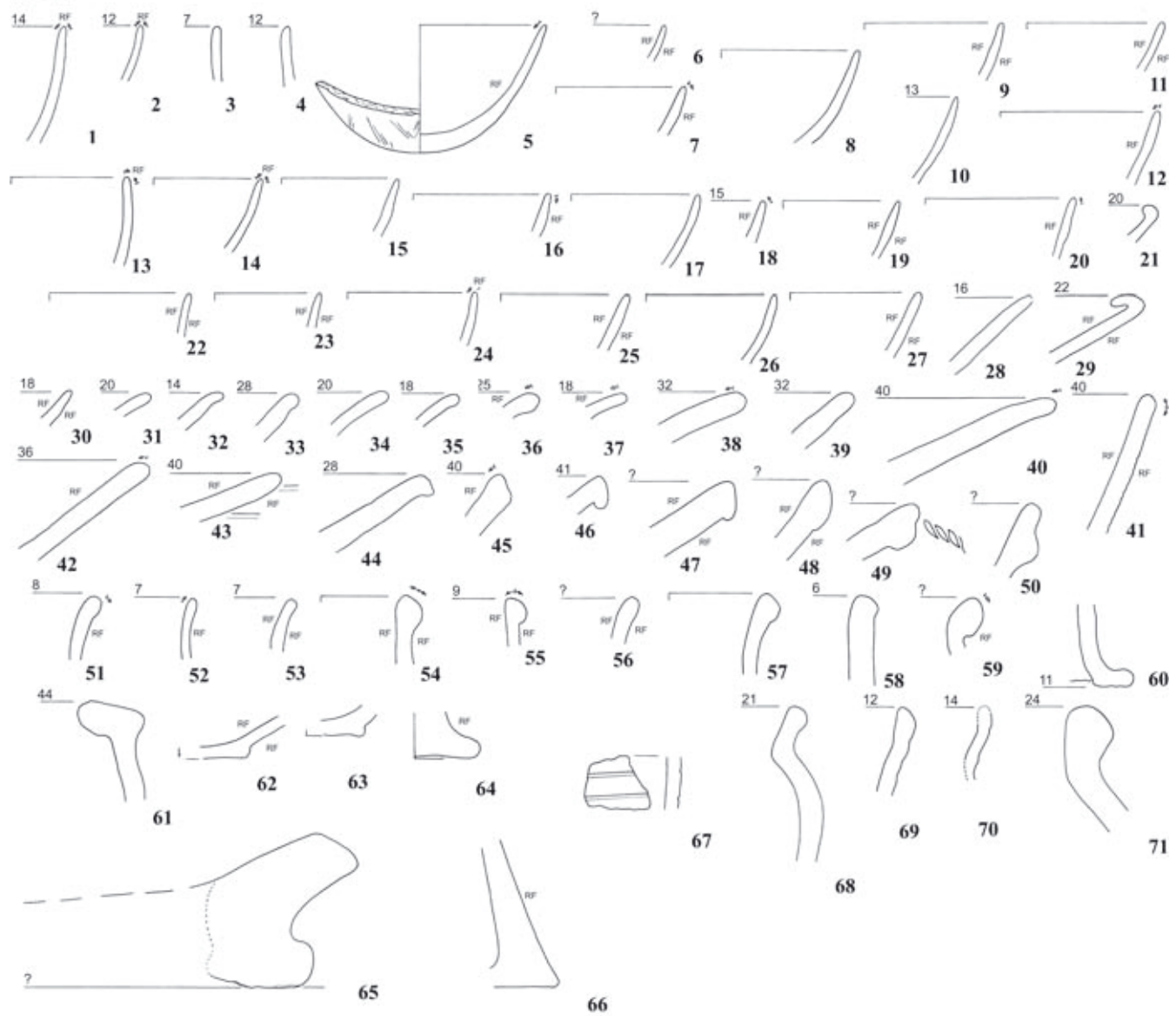

L520 (1)



K8338

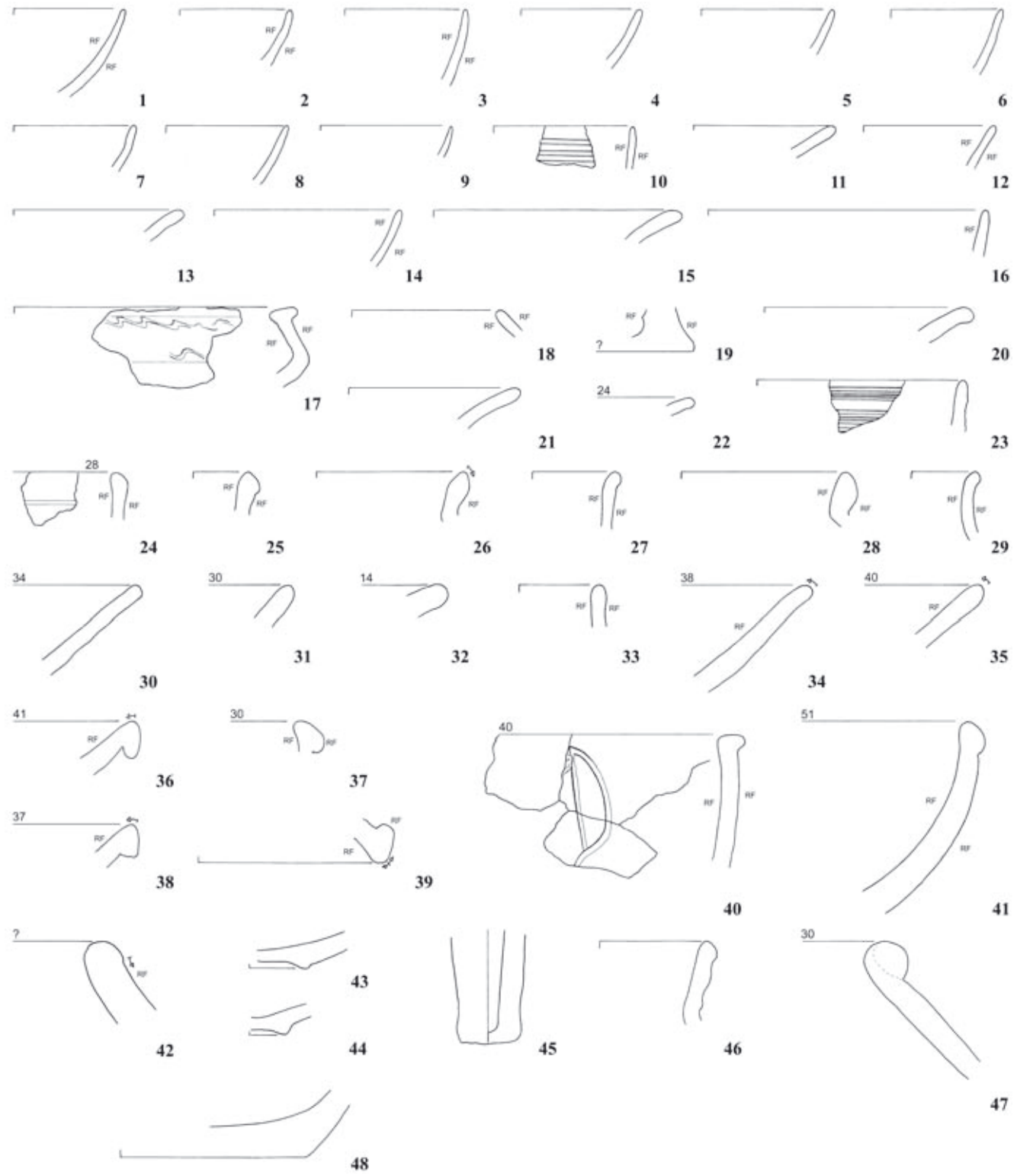

L520 (2)

K8339

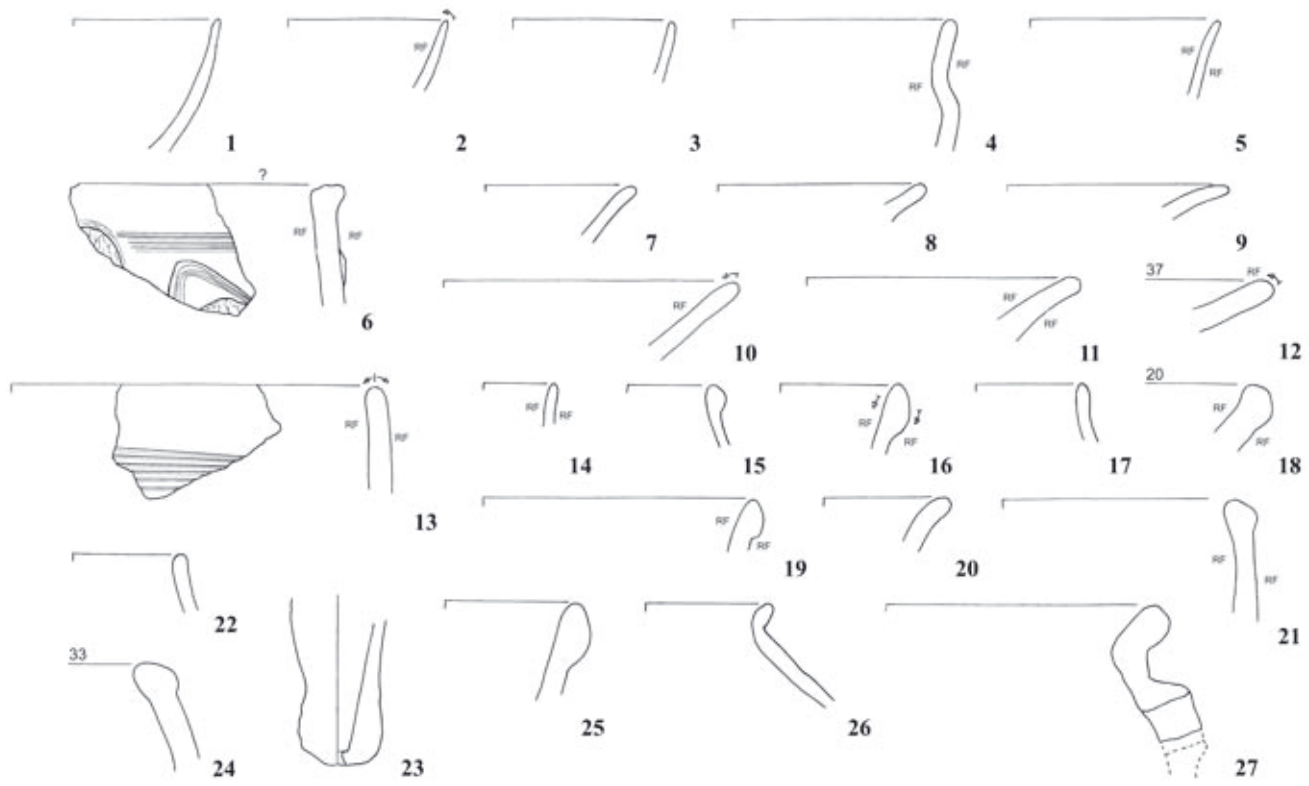

K8340

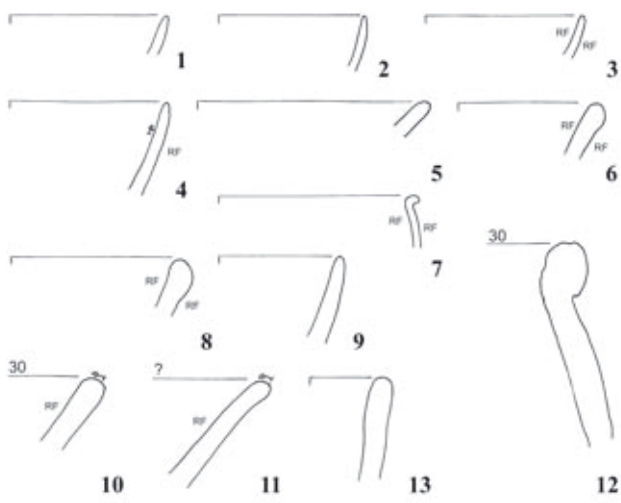

K8341

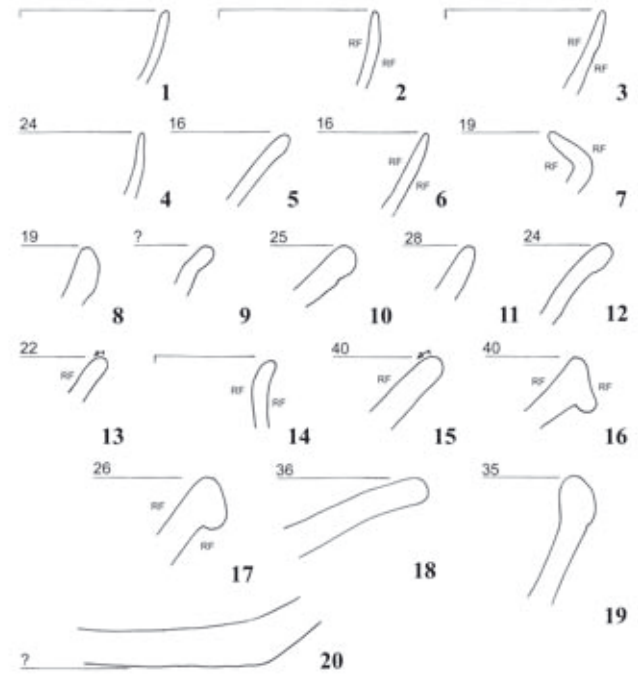

L520 (3)

K8342

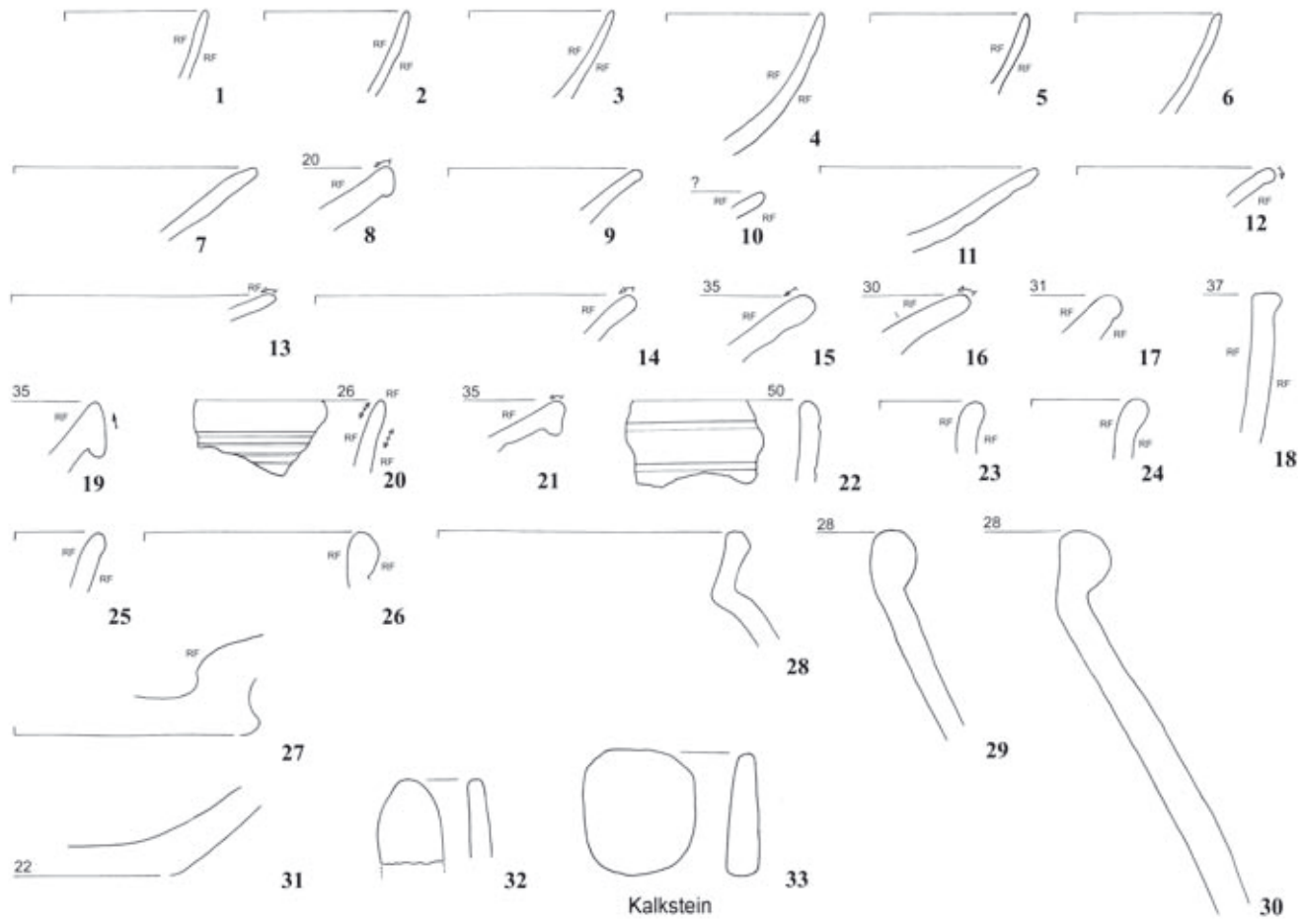

K8343

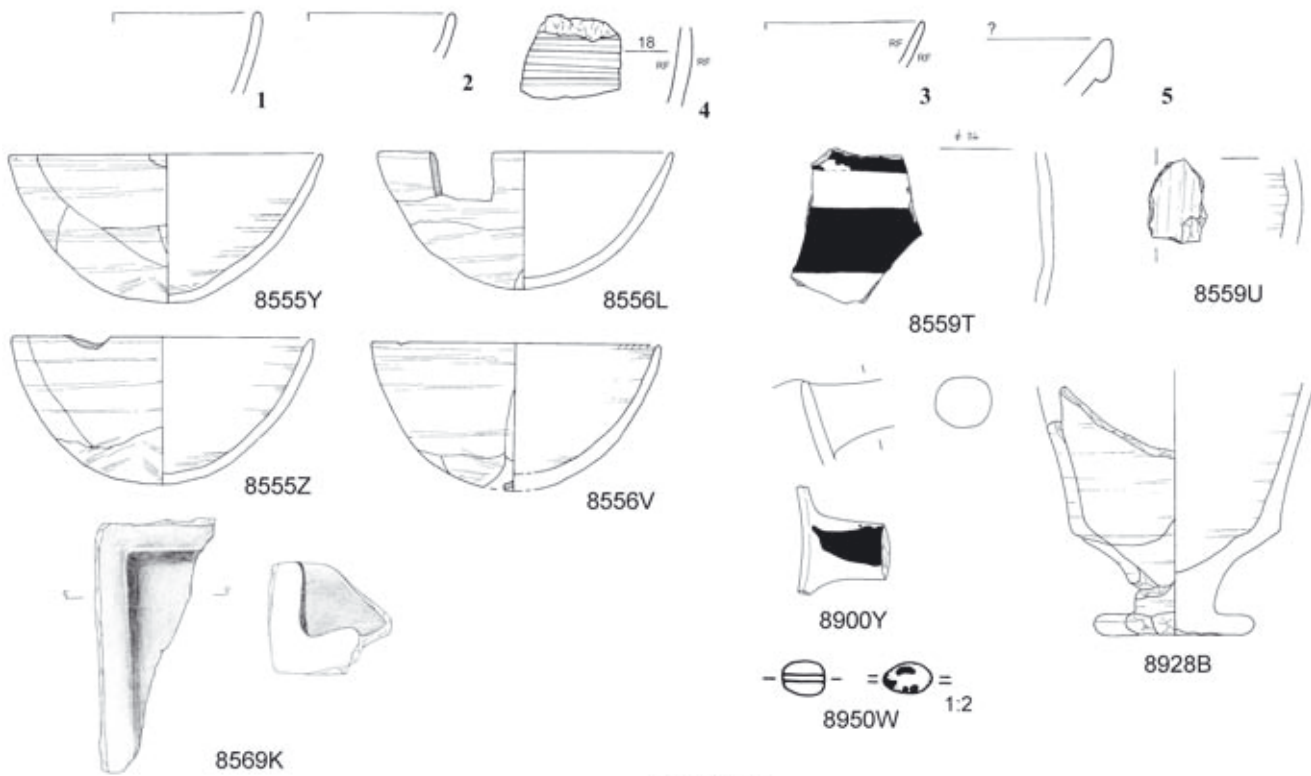

L520 (4)

Tafel 111

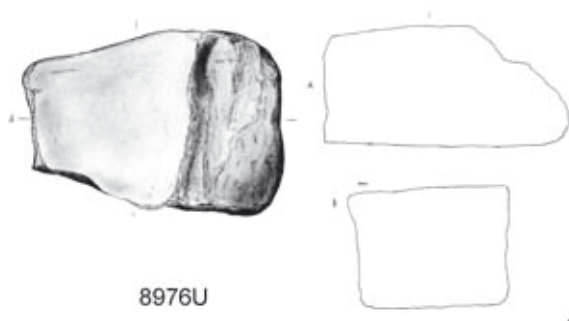

8976U

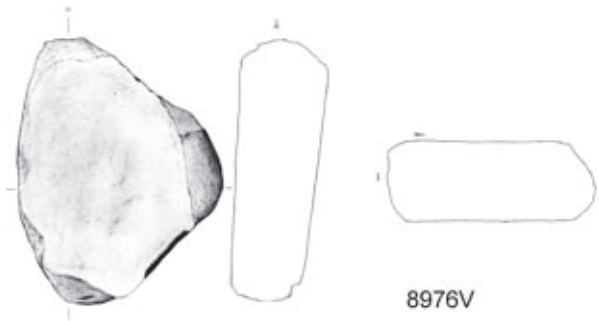

8976V

L520 (5)

K7936

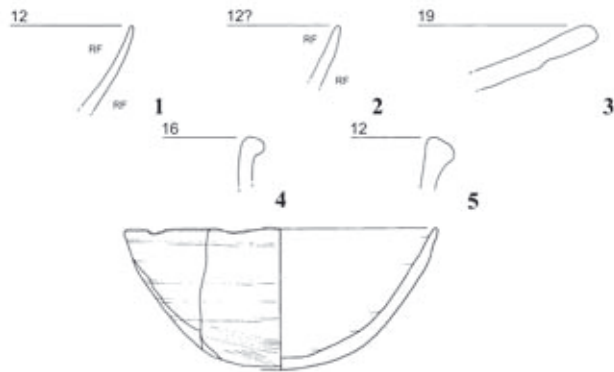

8913L

L521

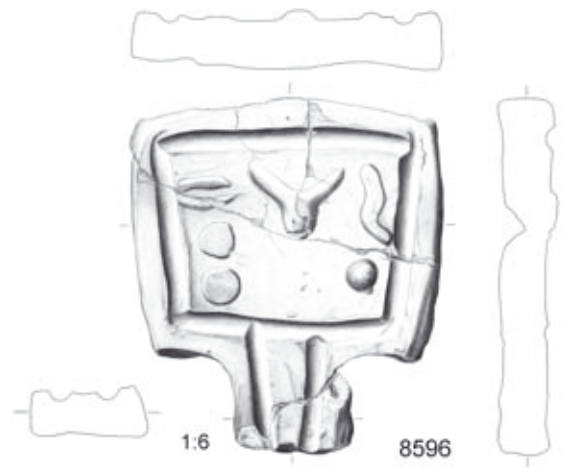

8596

K8336

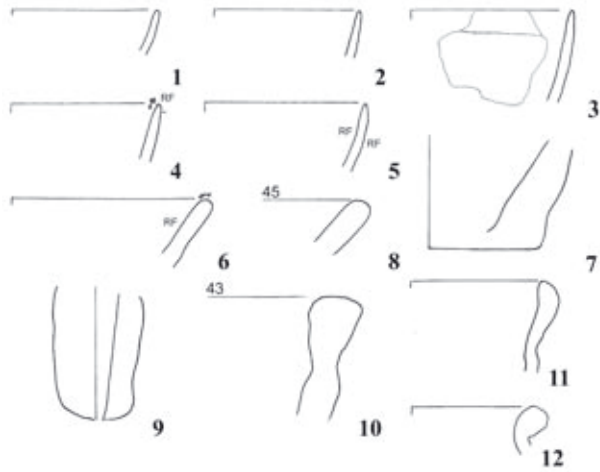

K8345

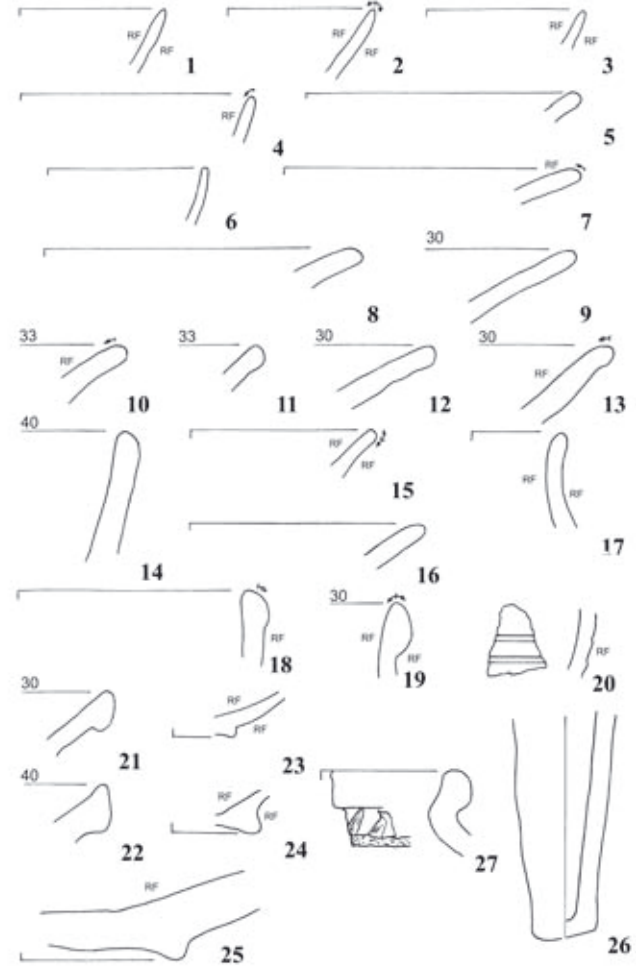

K8337

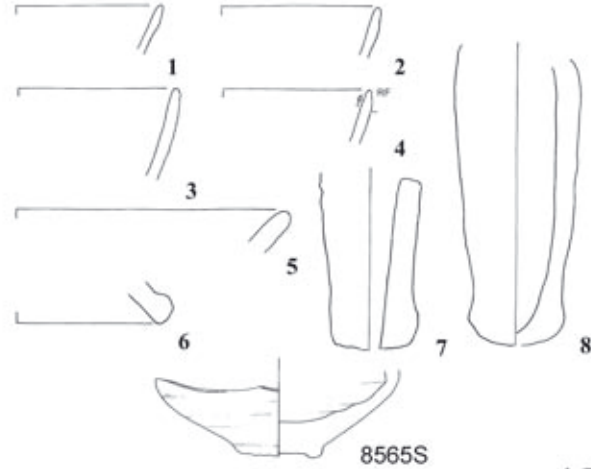

8565S

L522

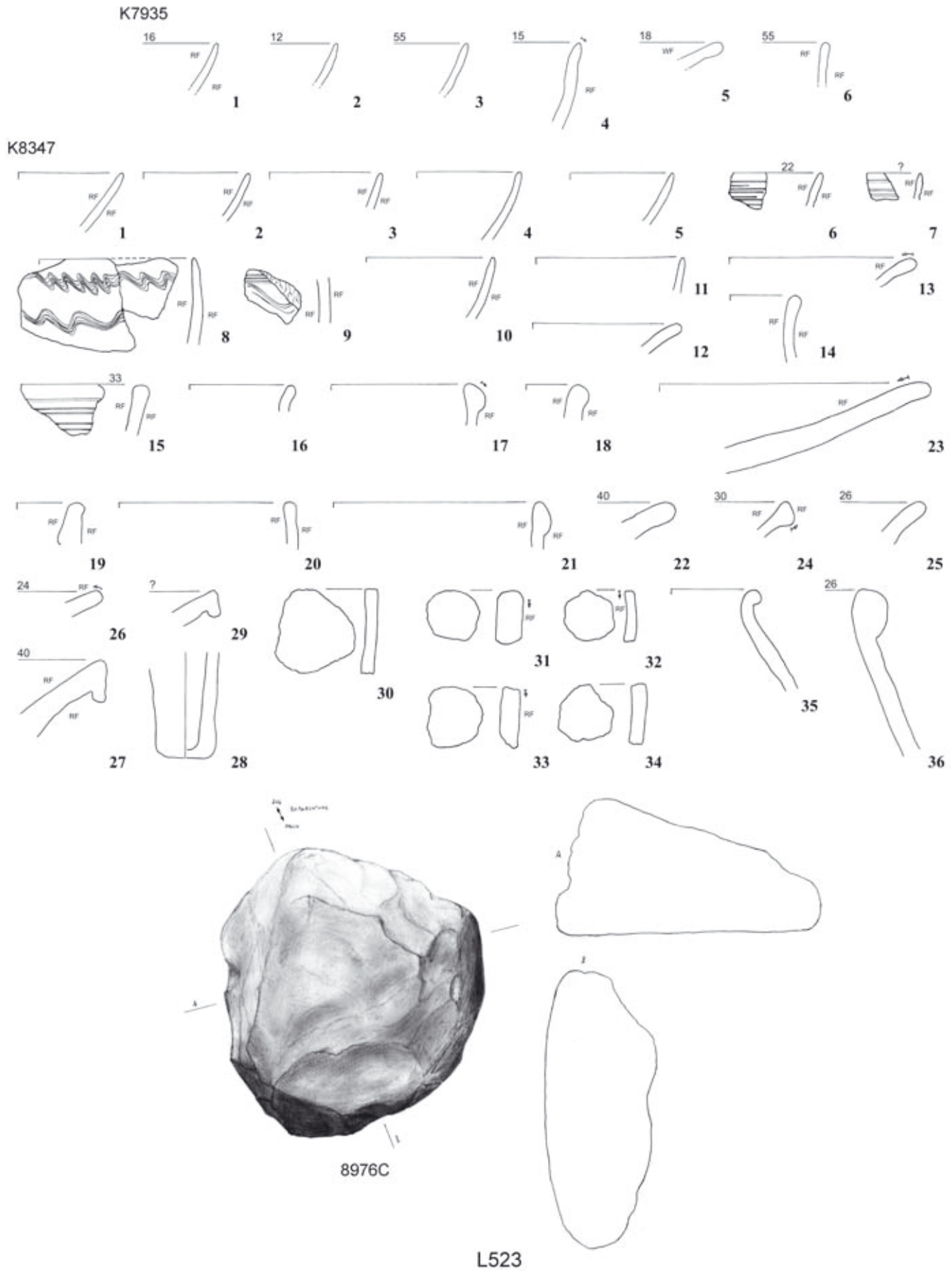

Tafel 113

K7933

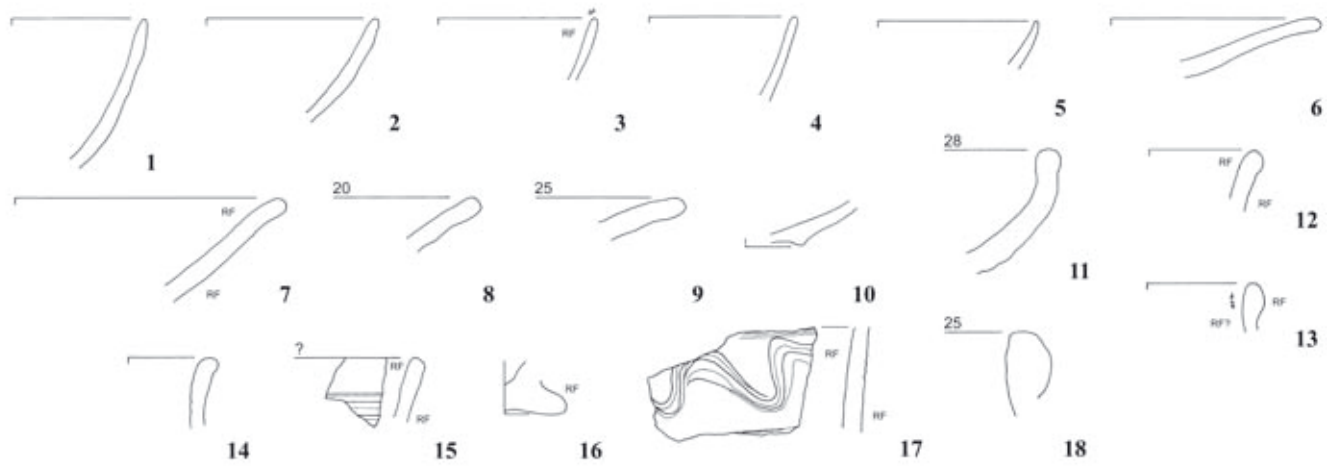

L524

K7972

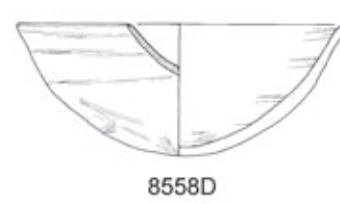
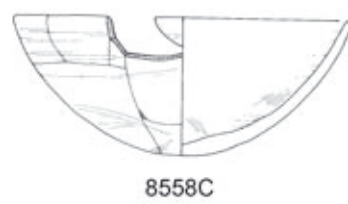
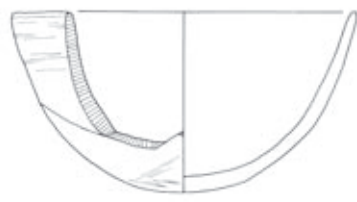
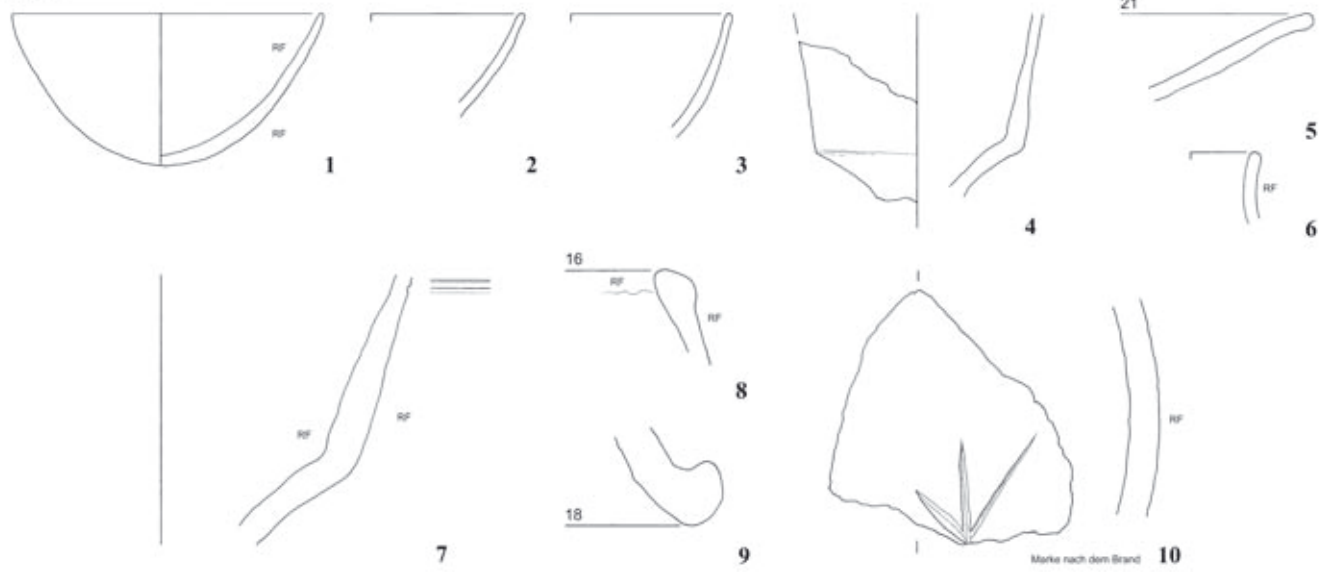

L526



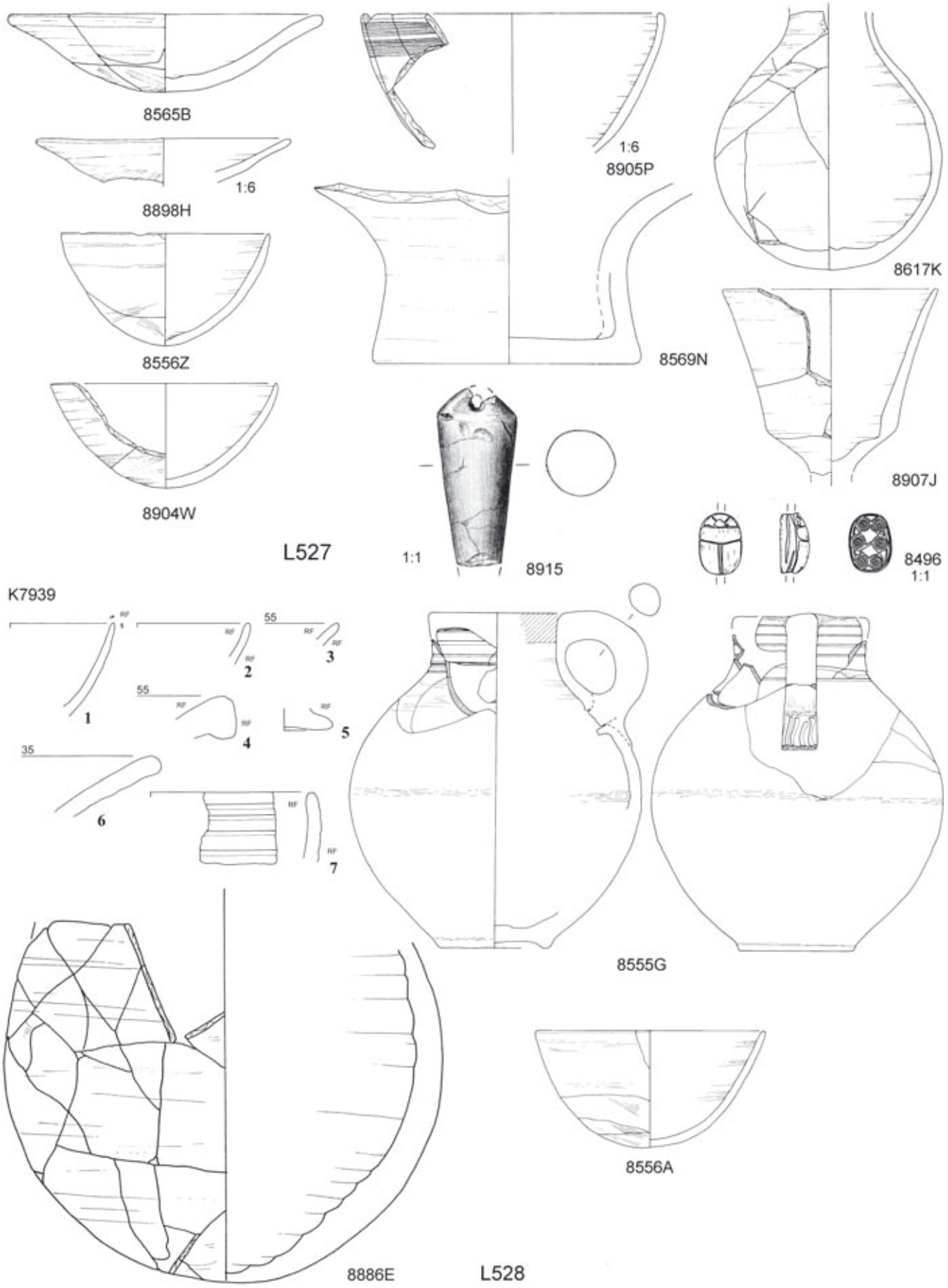

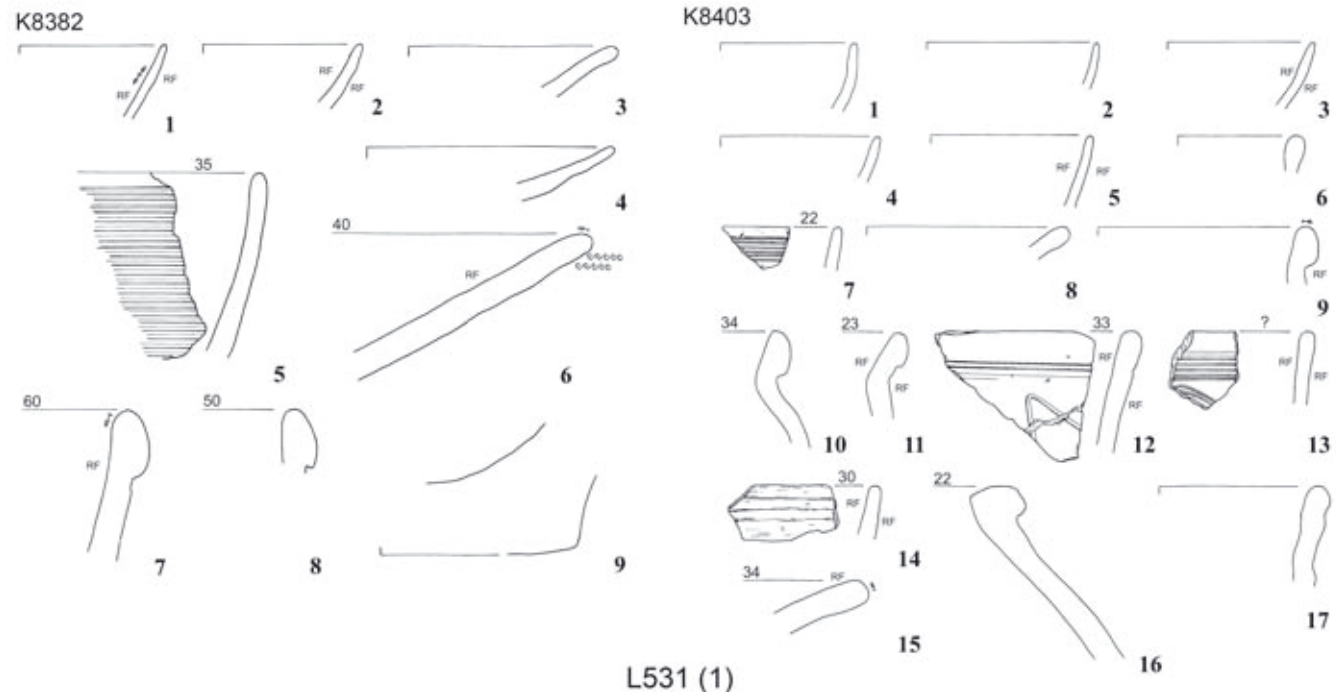
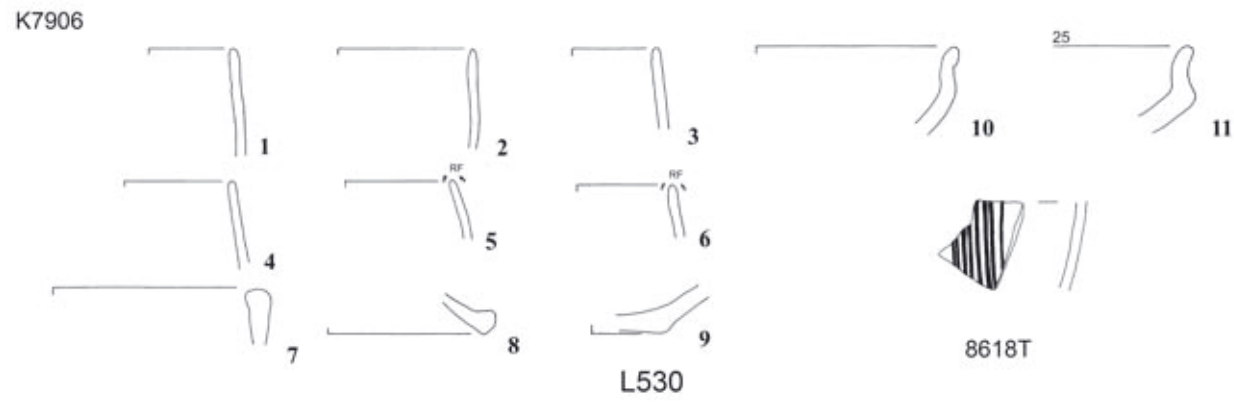
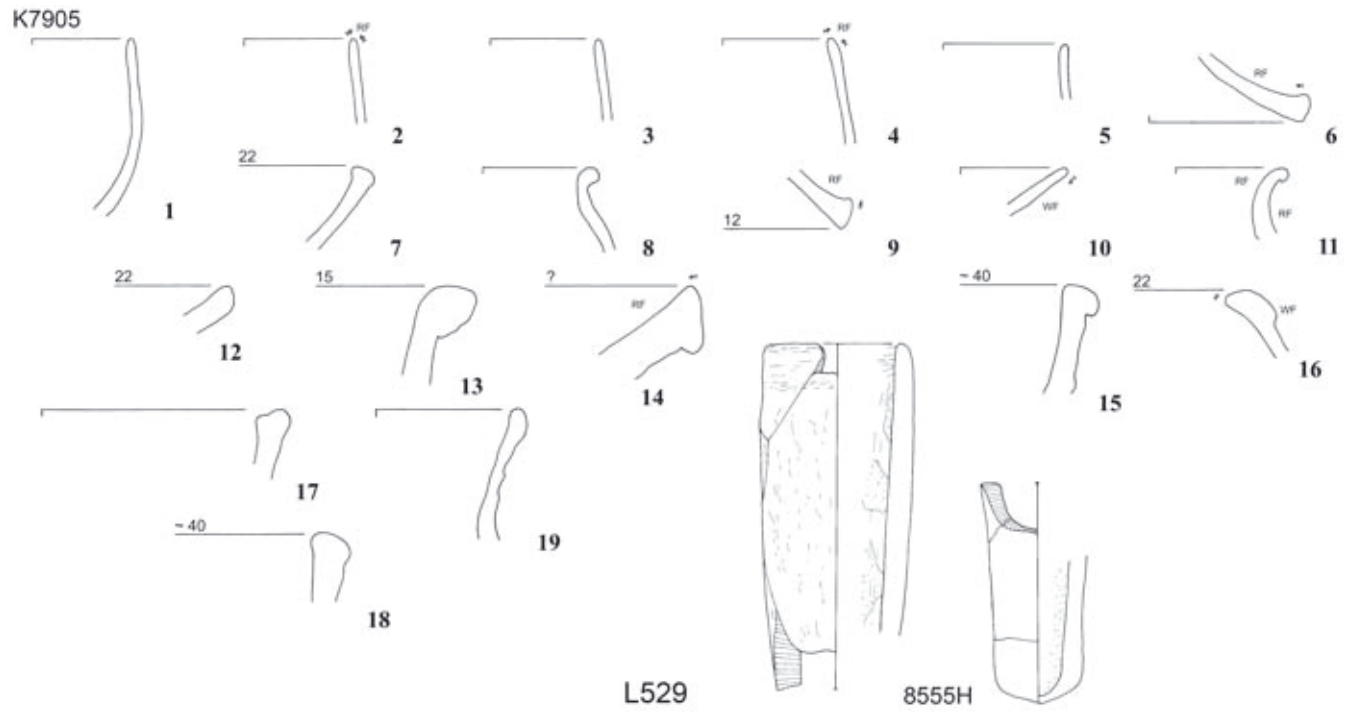



K8378



K8391

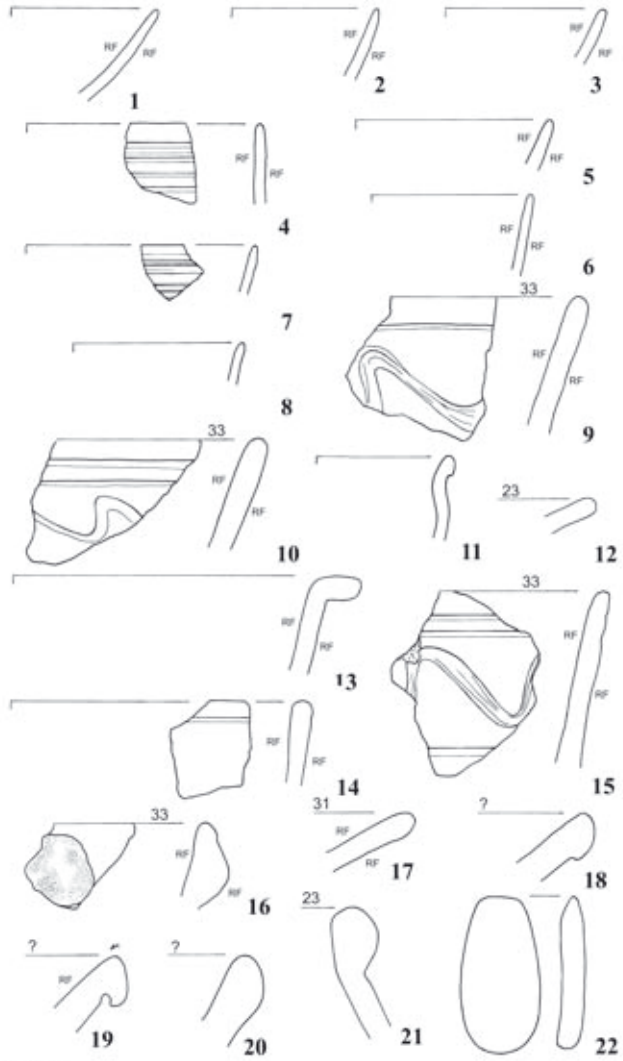

K8387

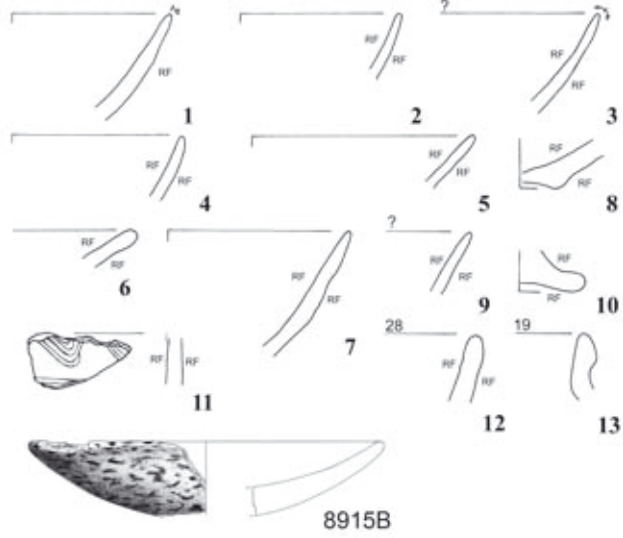

K8399

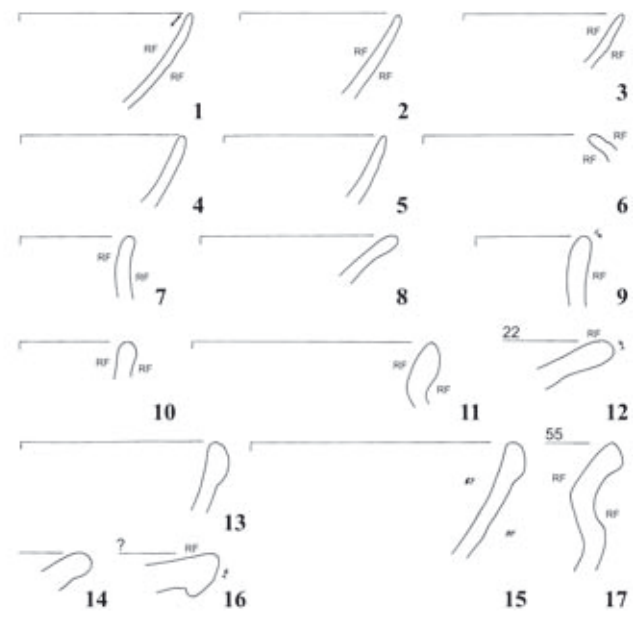

8977G

L532

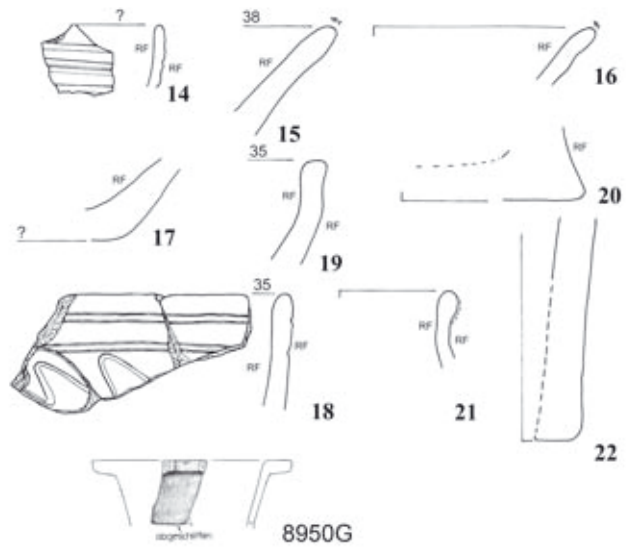

8950G

L533

K8379

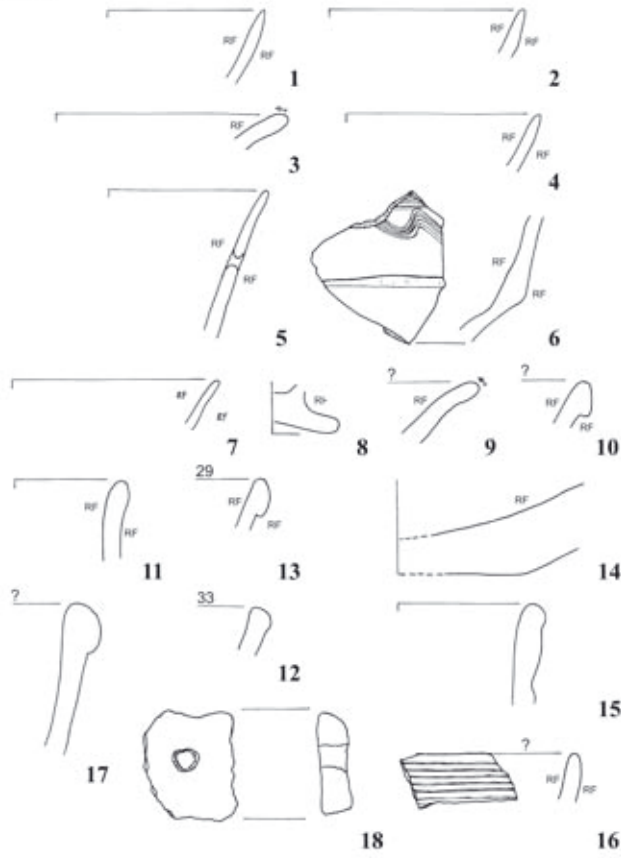

8565M

L534

K8332

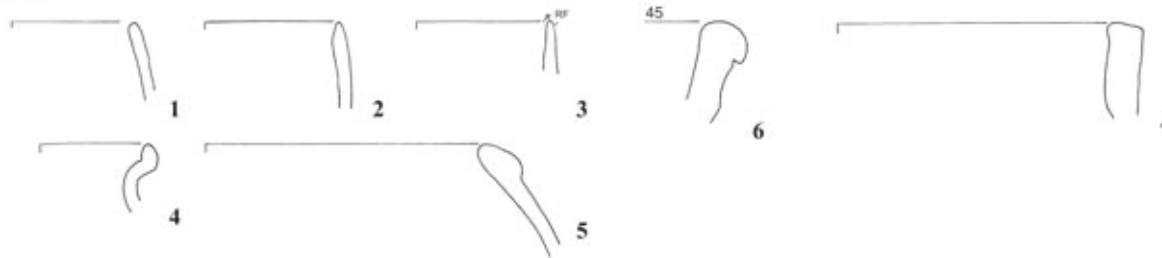

K8334

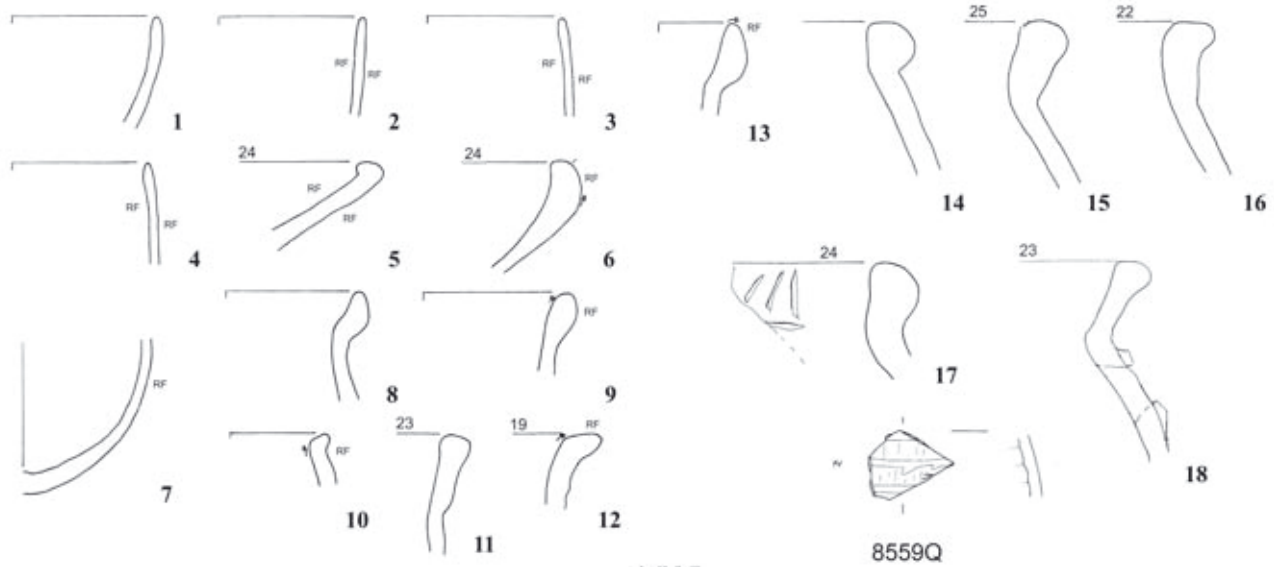

8559Q

L535

Tafel 119



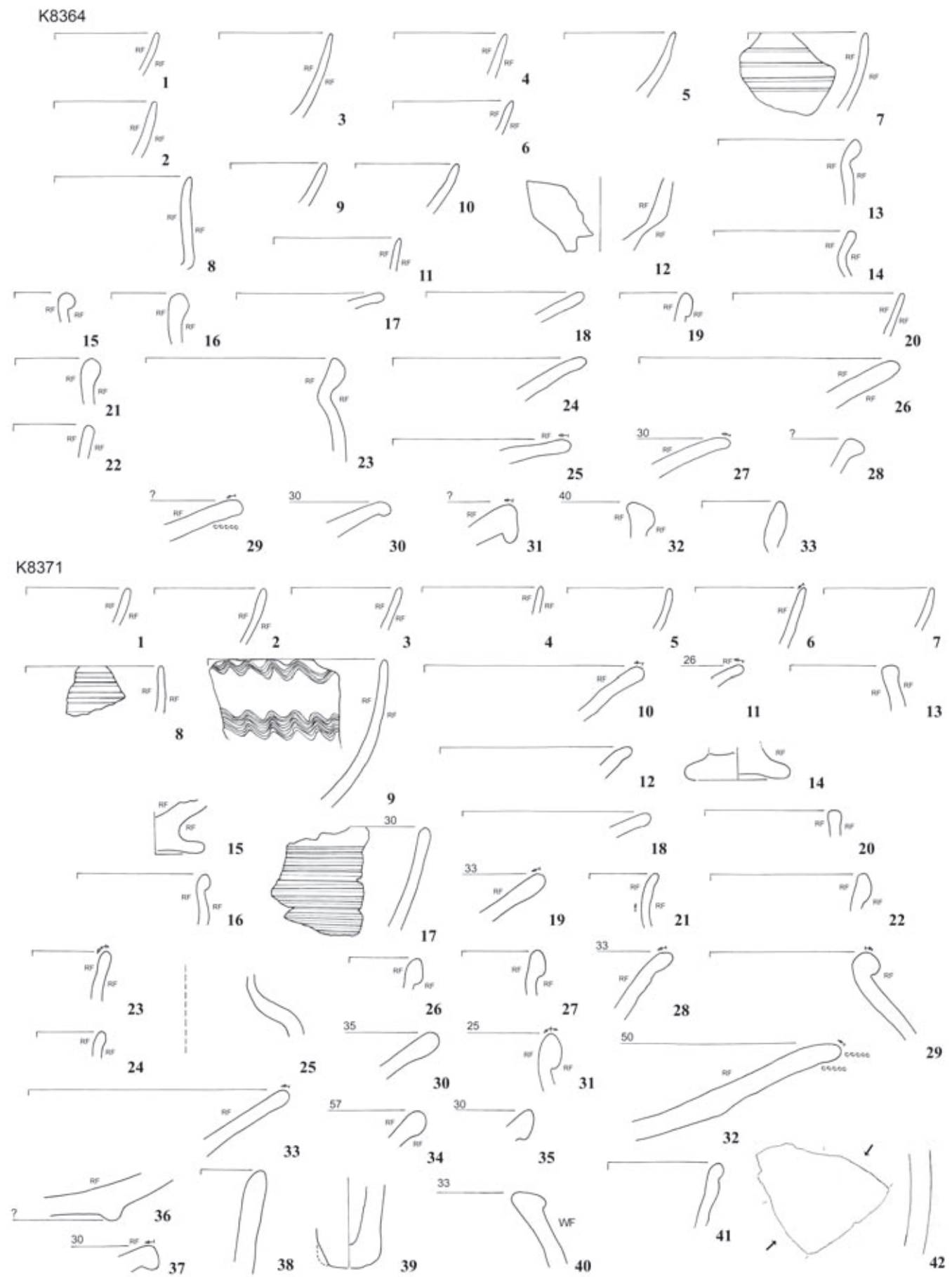

L536 (1)

Tafel 120



K8372

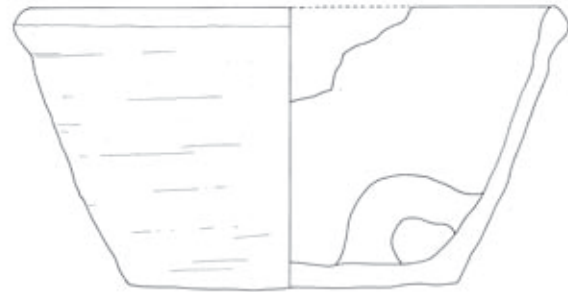
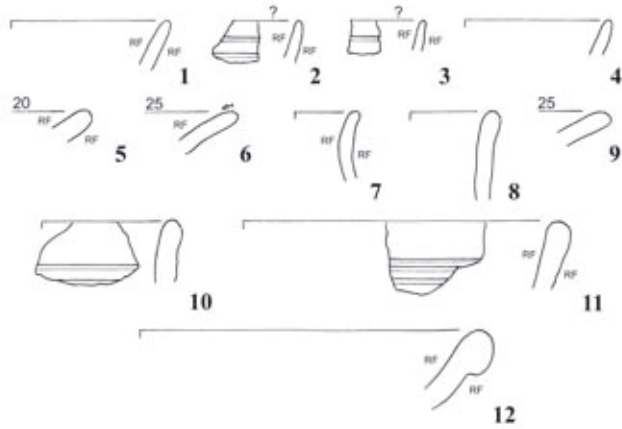

8559H

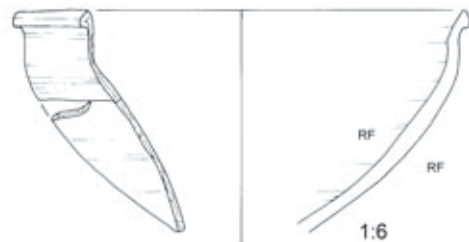

8565W

1:6



8565X

1:6

L536 (2)

K8265

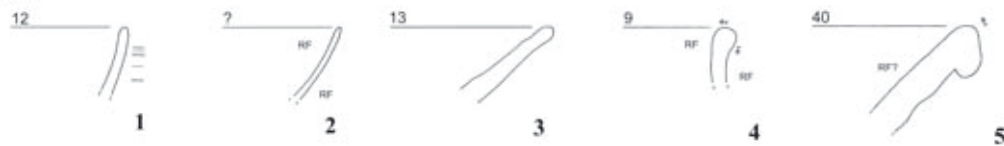

L539

K7925

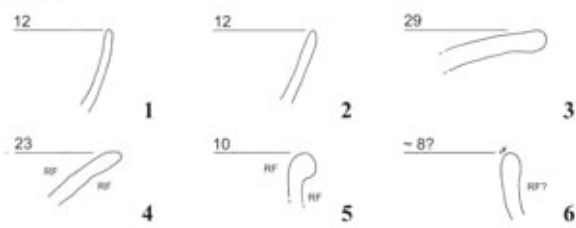

L540

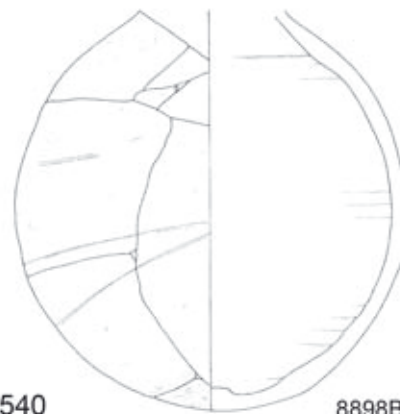

8898B



8977Q



8555U



8555V

L542

K8333

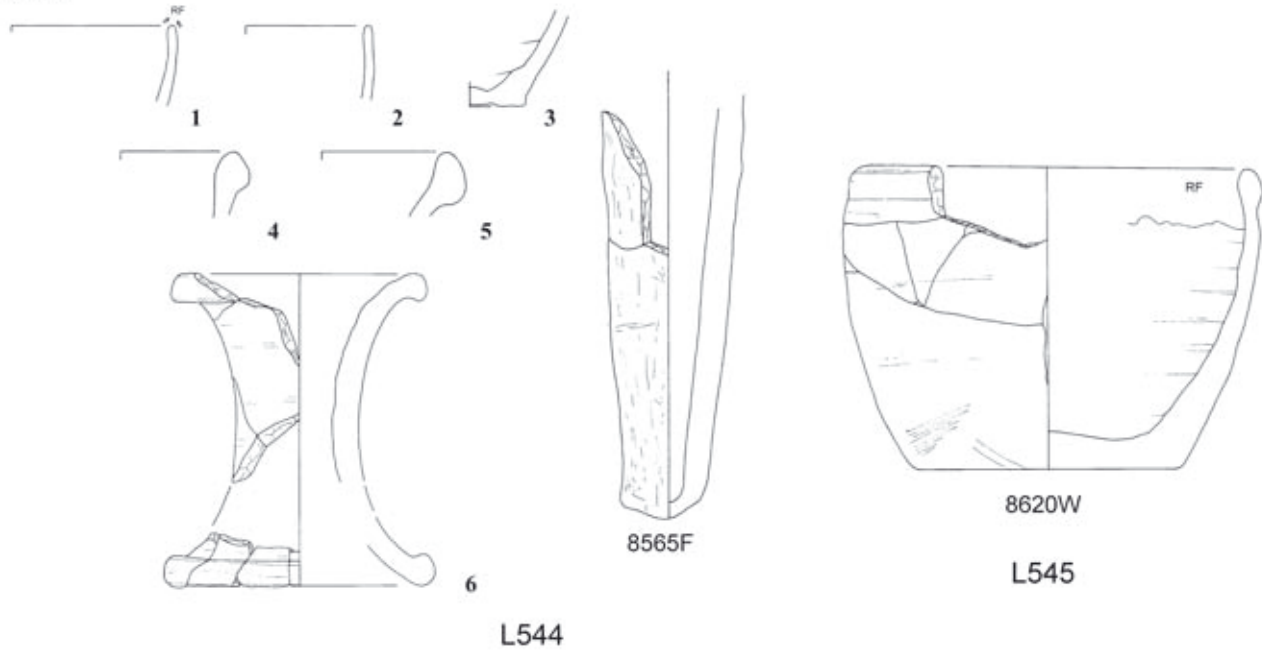

K8315  
-40

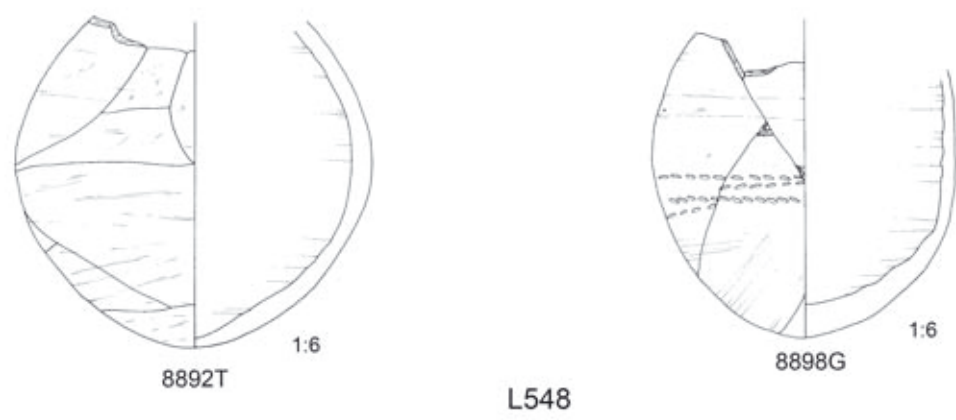
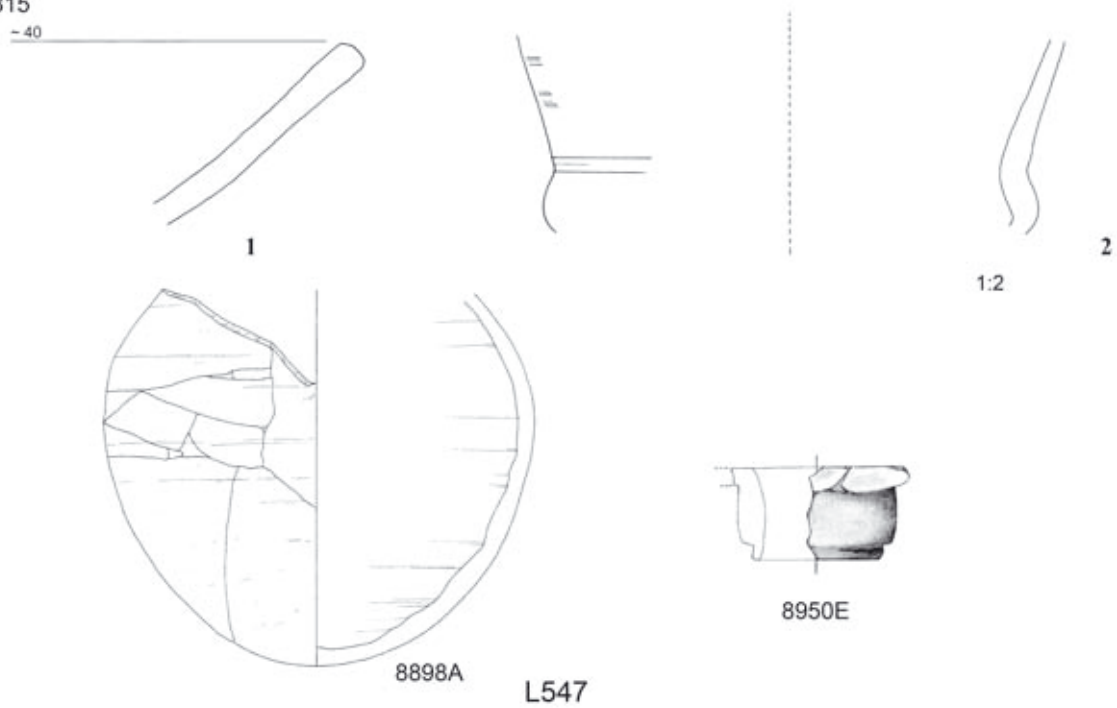

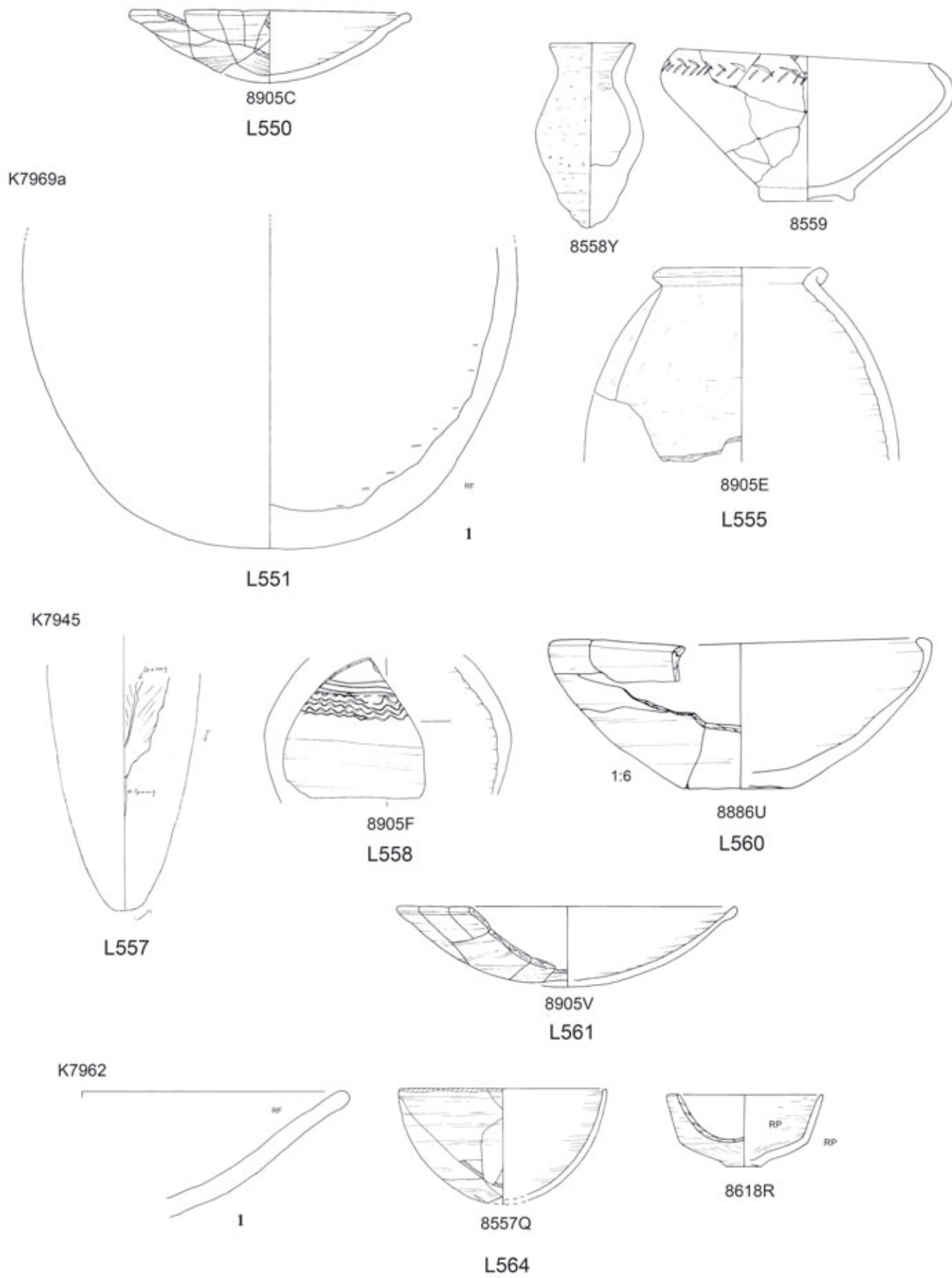

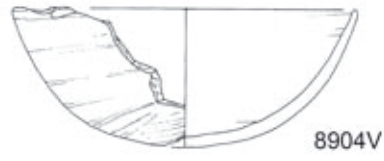

L567

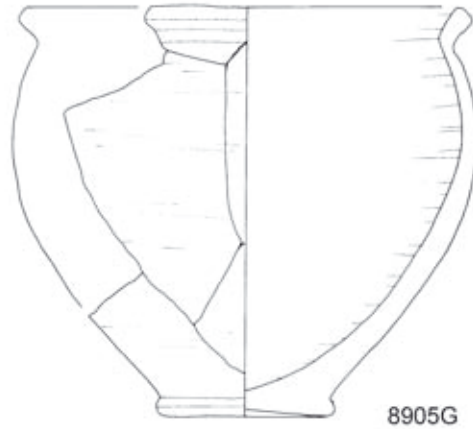

L568

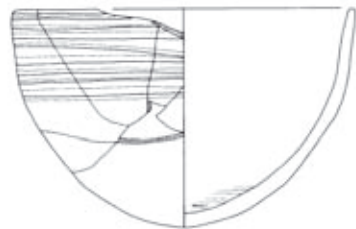

8556F

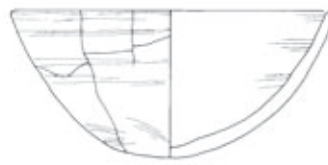

8556U

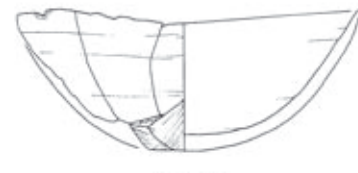

8904X



8892U

1:6

L569



8558X



8556B

L576

K8377

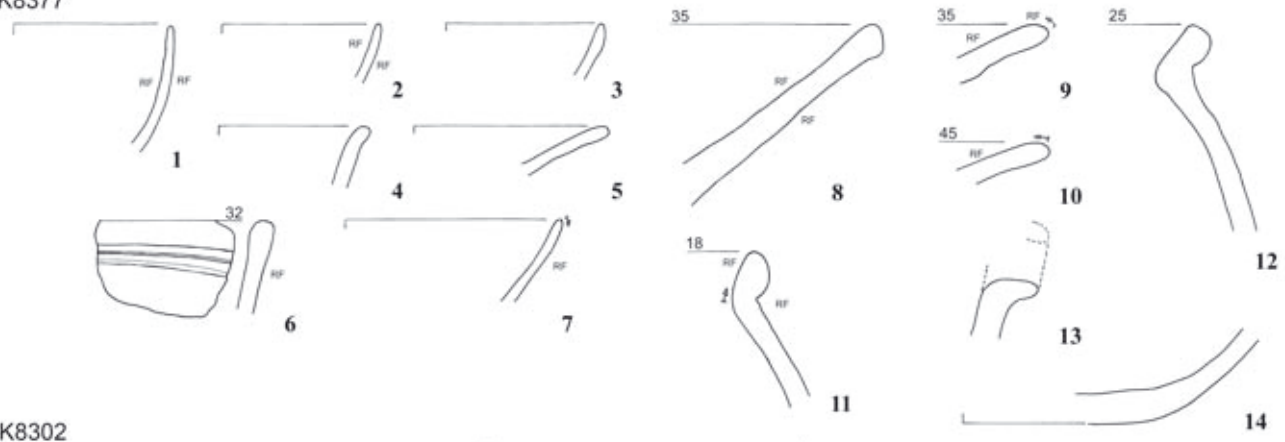

K8302

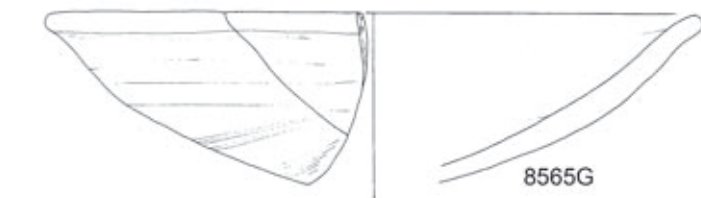
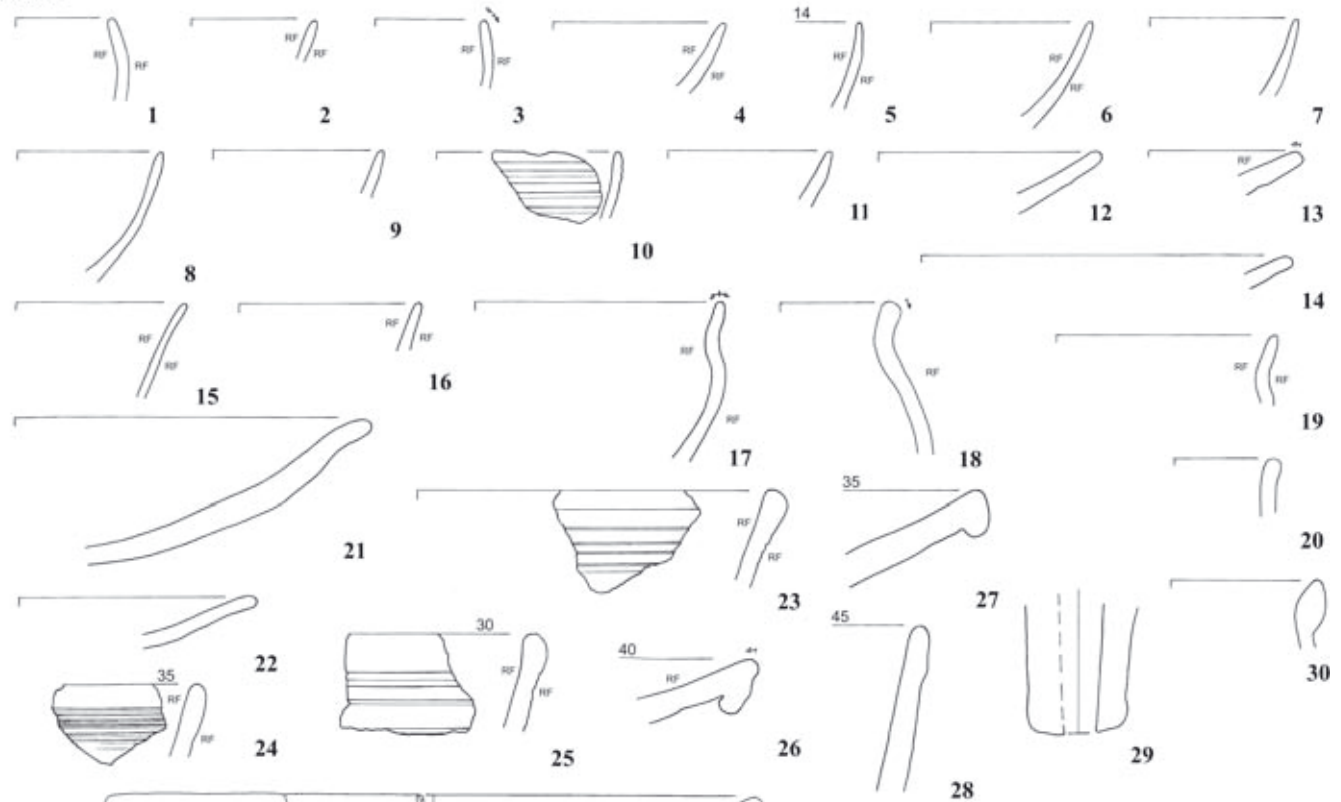

8565G

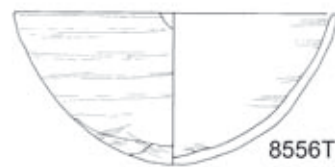

8565T

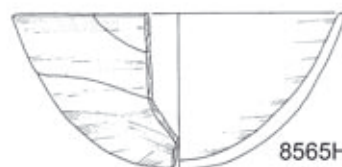

8565H

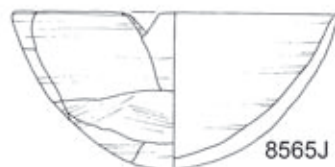

8565J

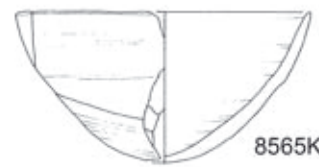

8565K

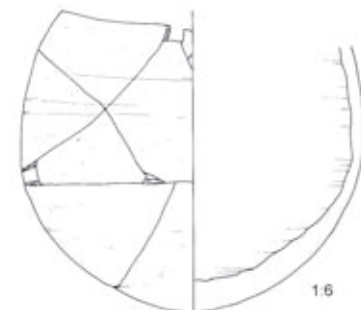

8900K

1.6

L579

Tafel 125

K8395

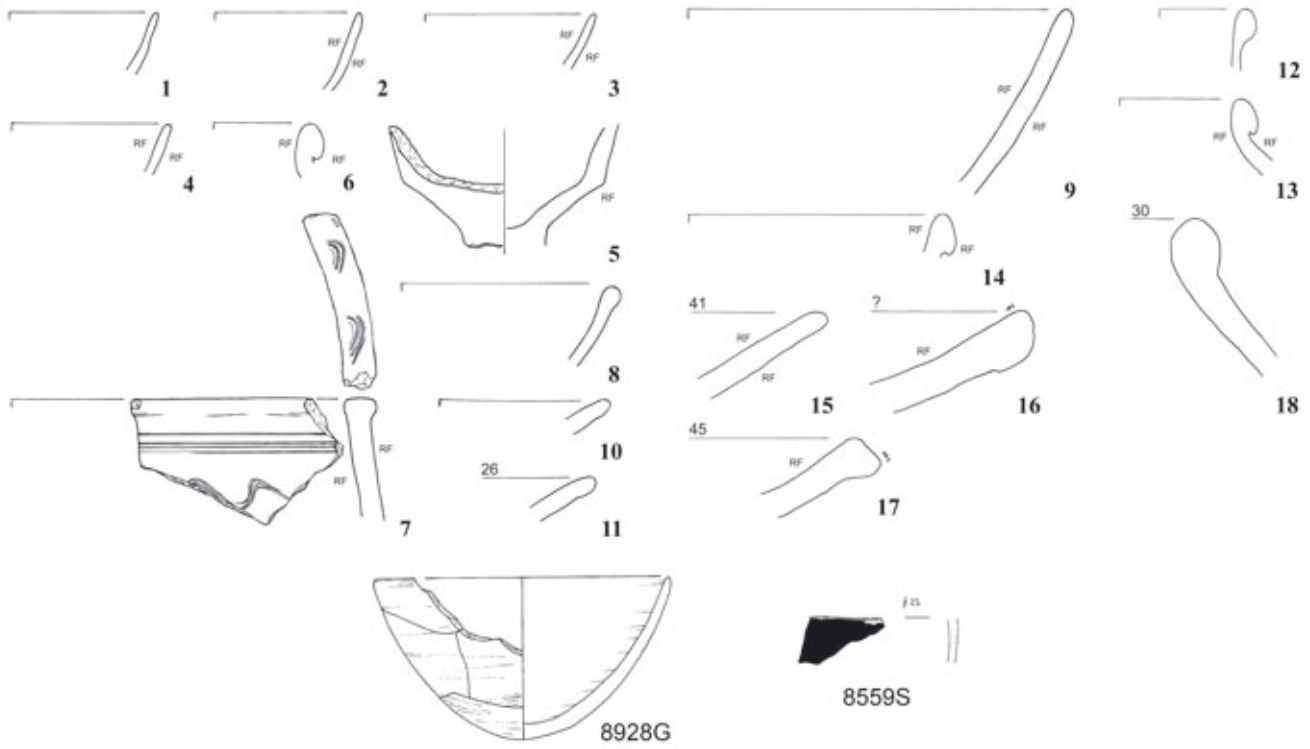

K8400

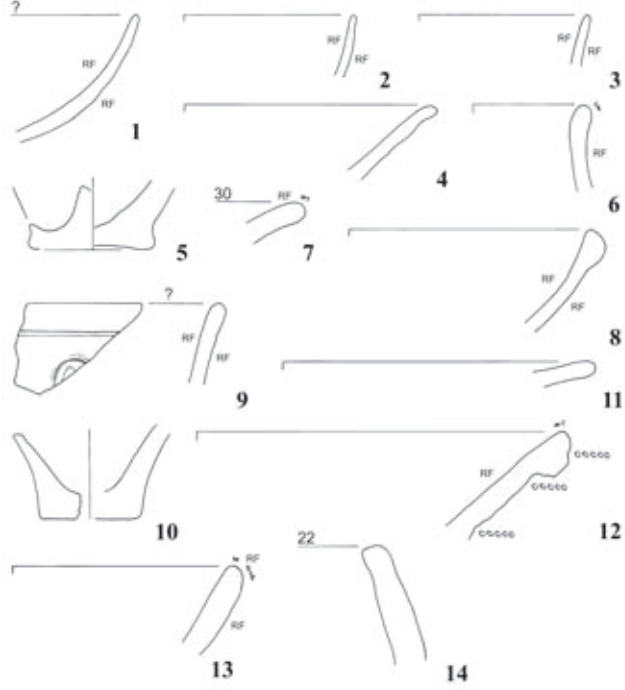

L580

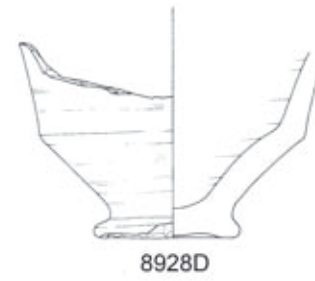

K8402



L583

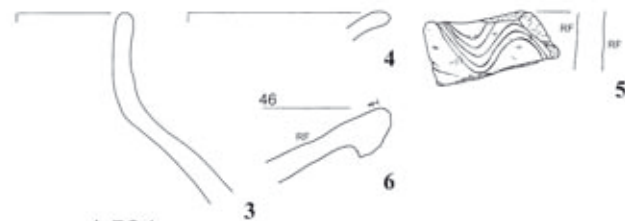

L584



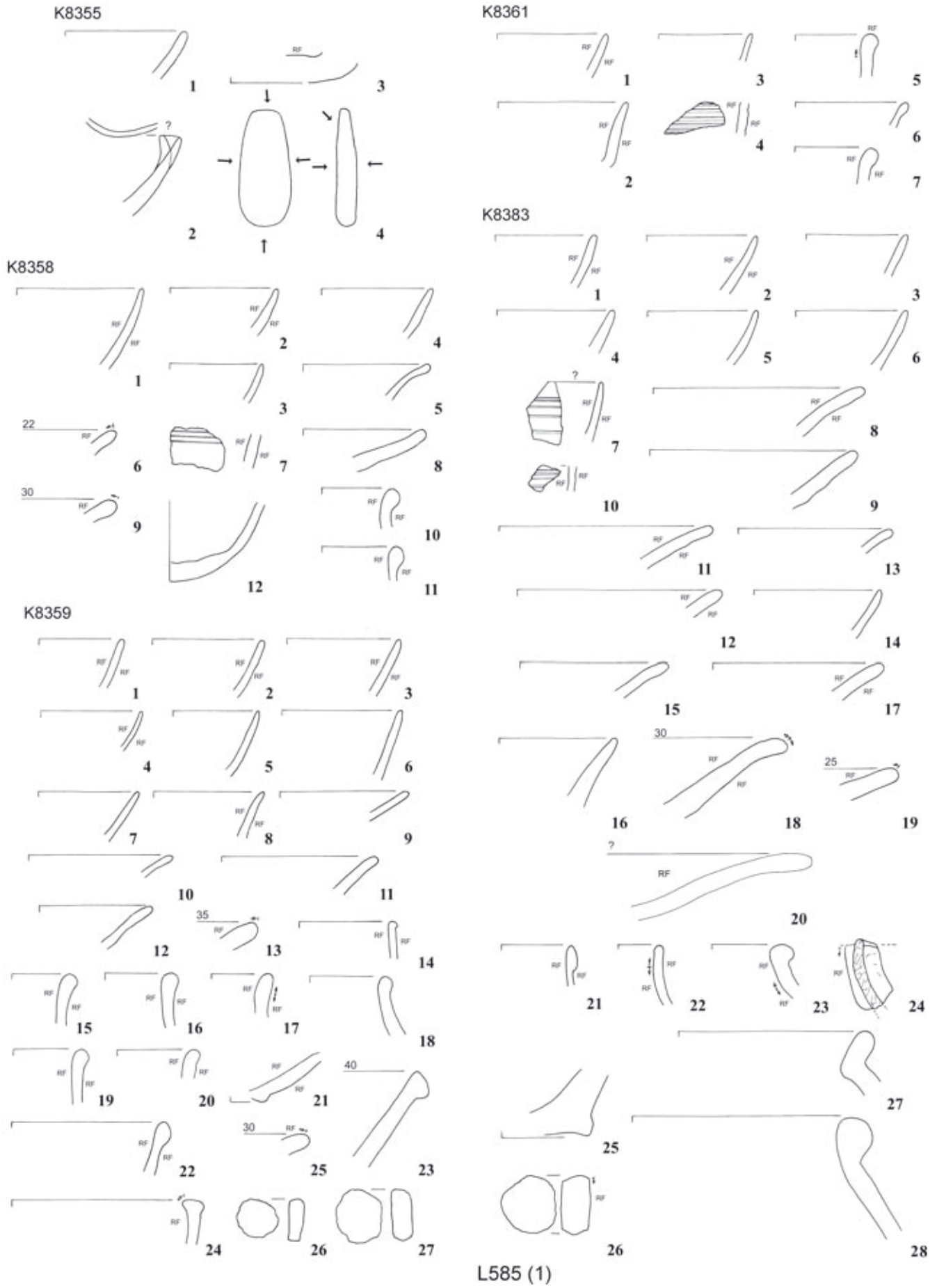

Tafel 127

K8384

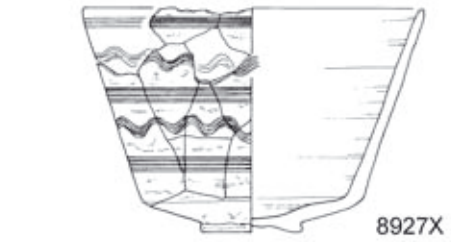
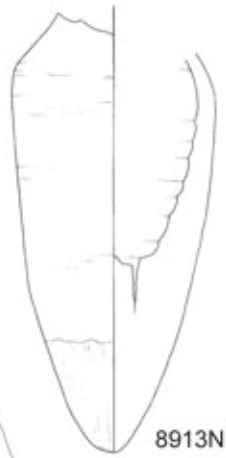
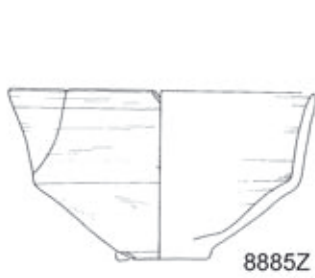
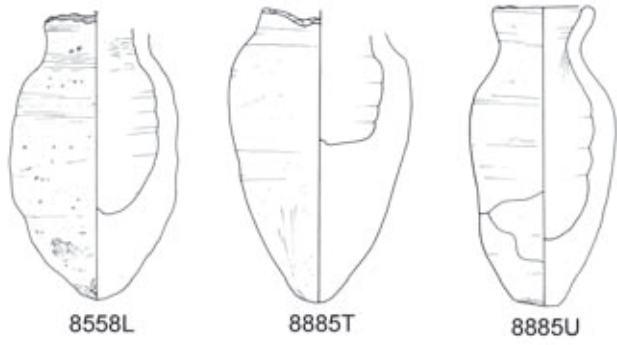
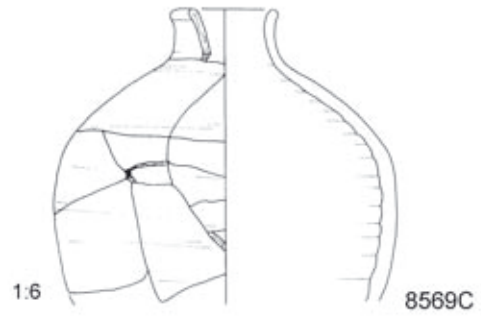
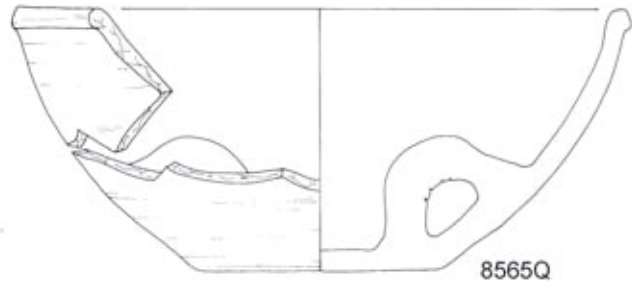
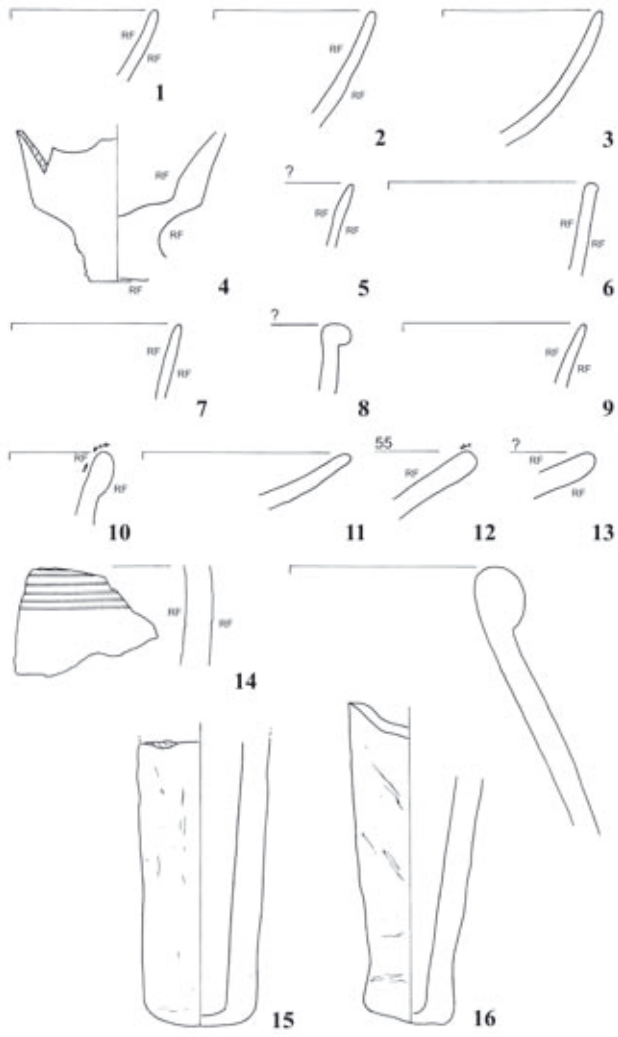

L585 (2)

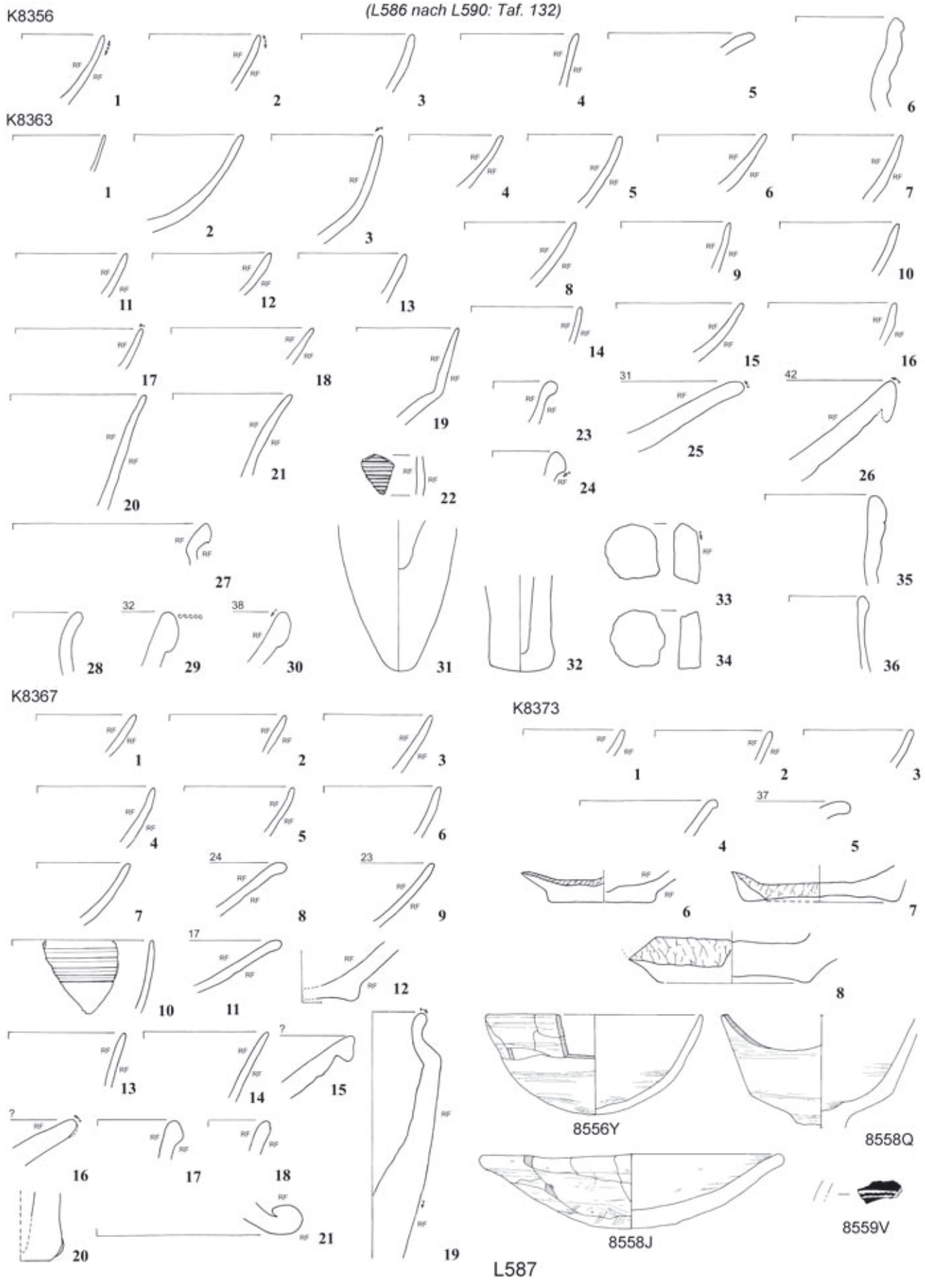

Tafel 129

K8354

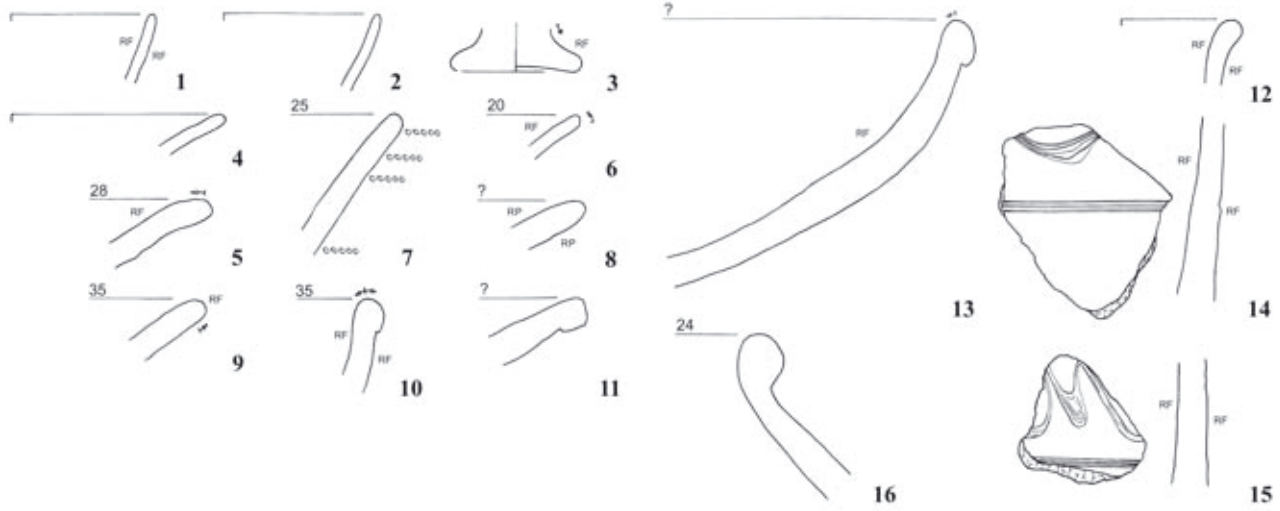

K8360

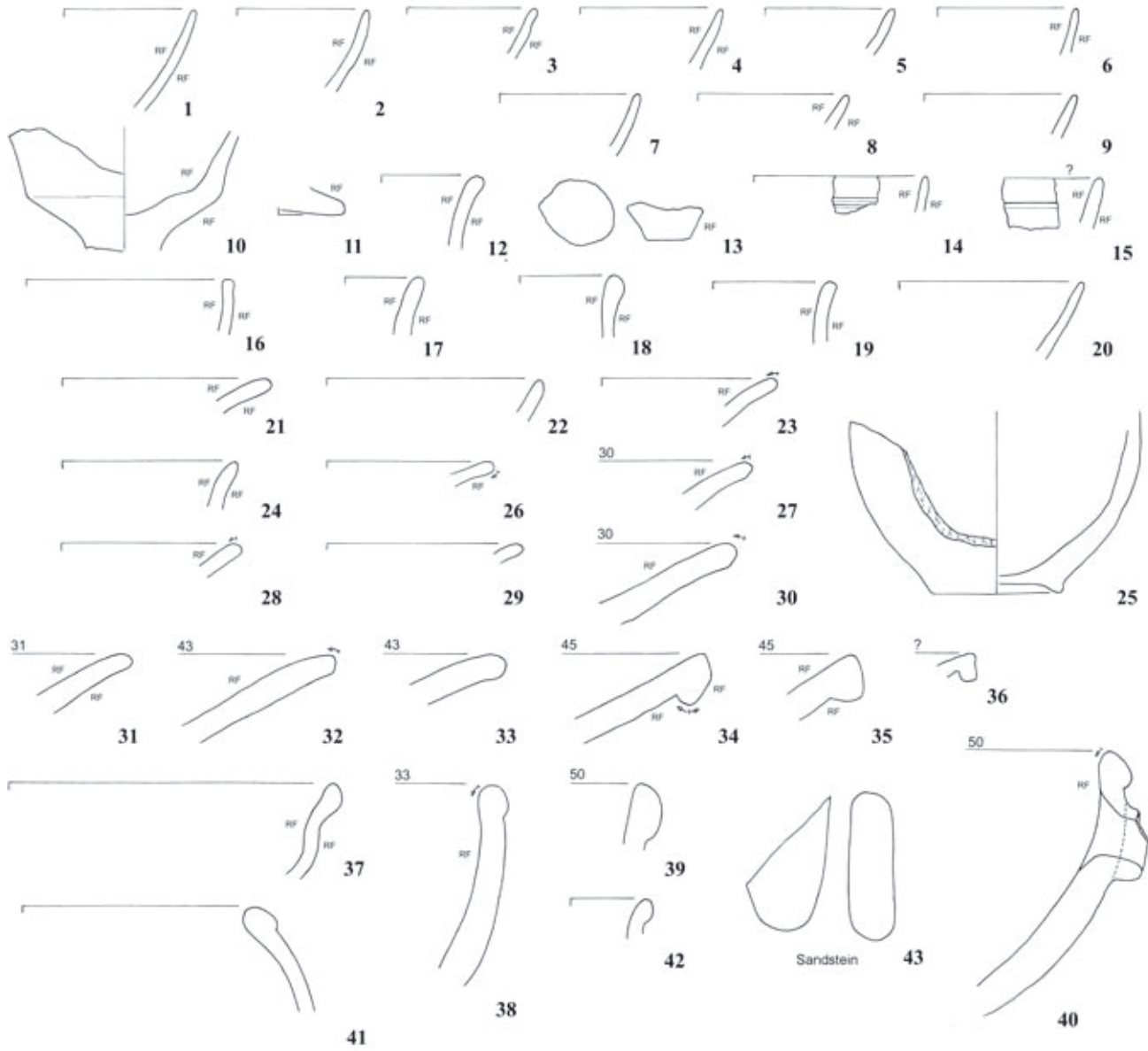

L590 (1)

K8369

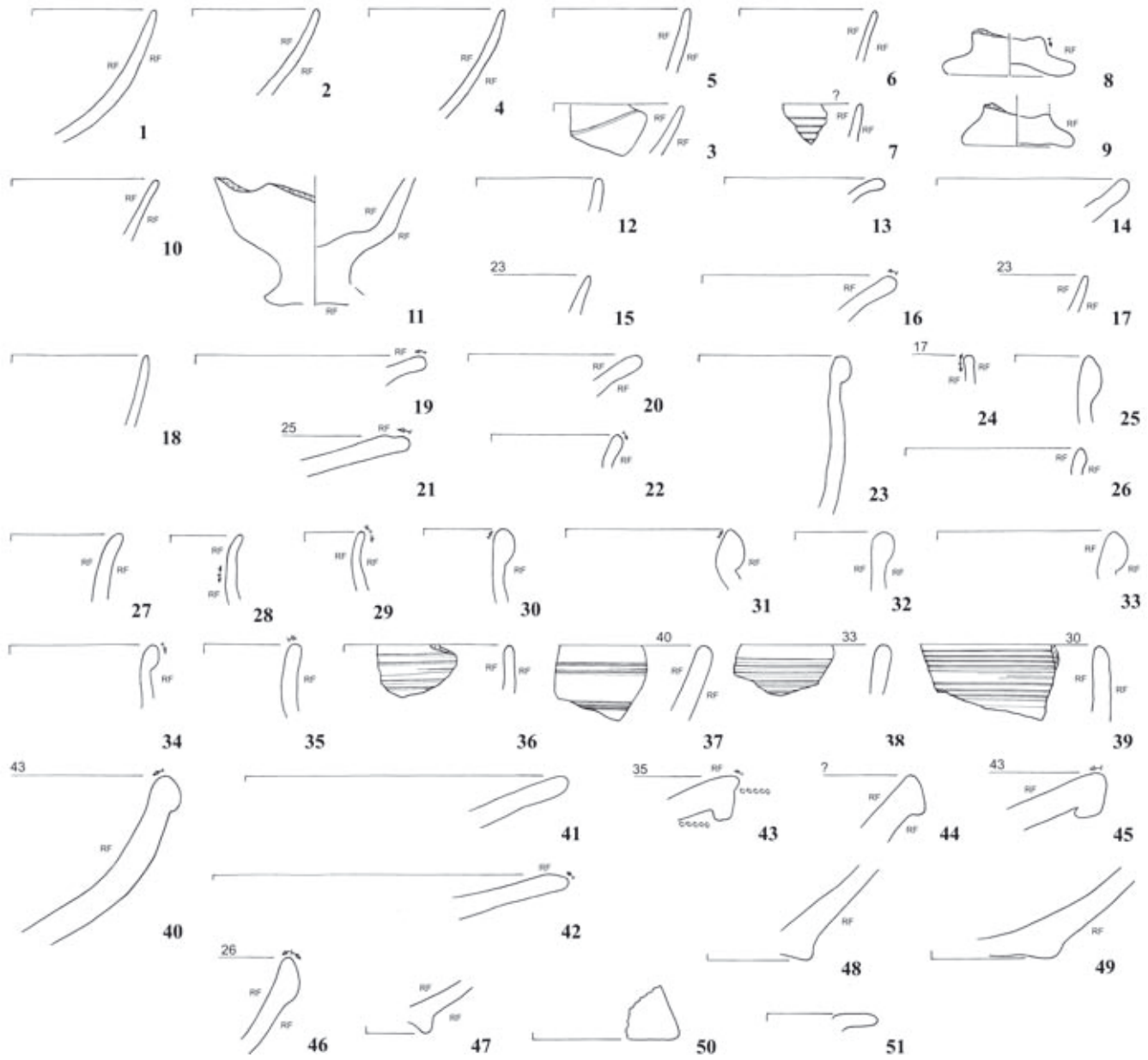

K8374

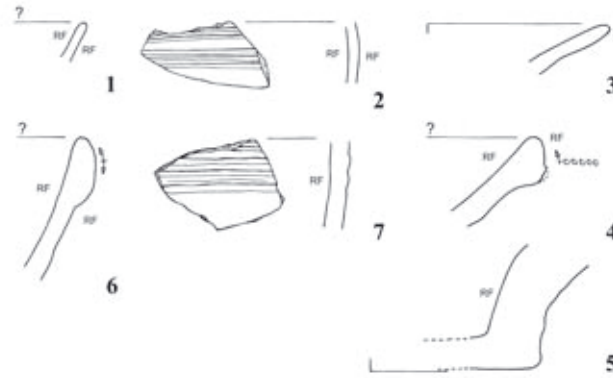

L590 (2)



K8385

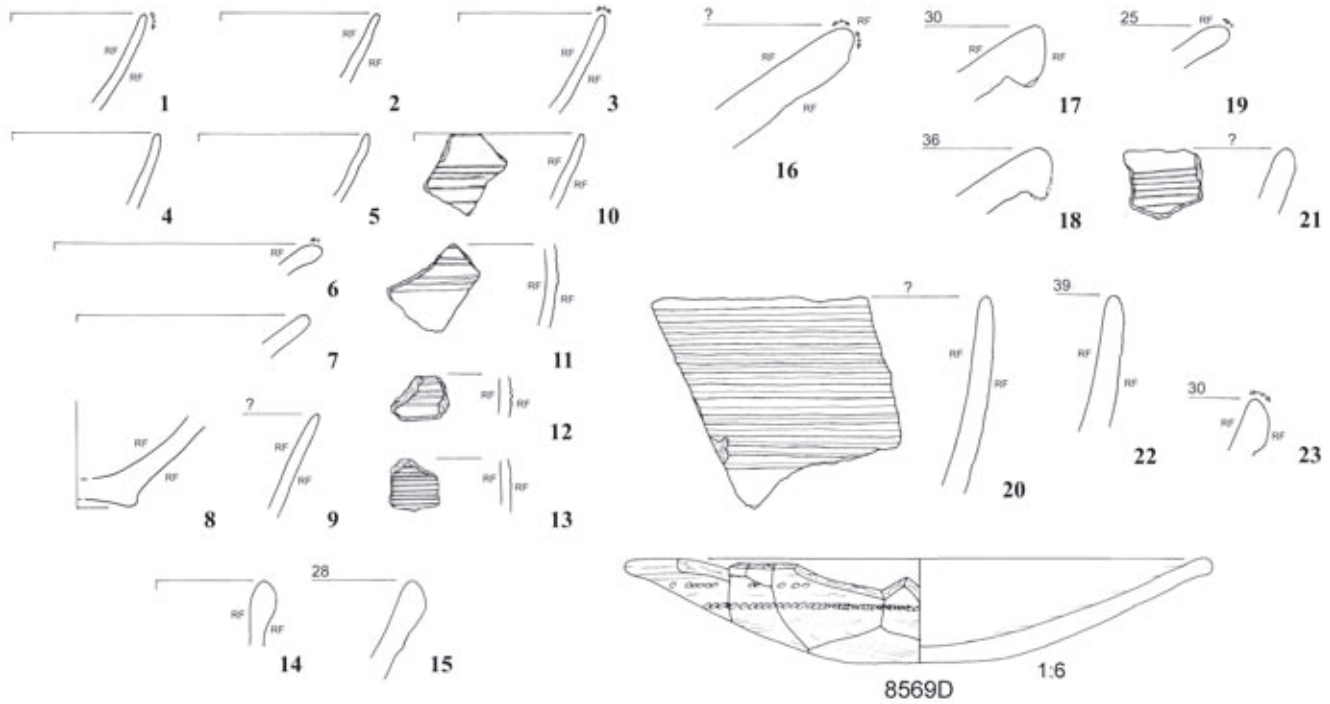

K8357

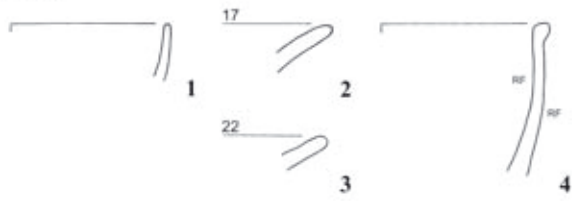

K8362

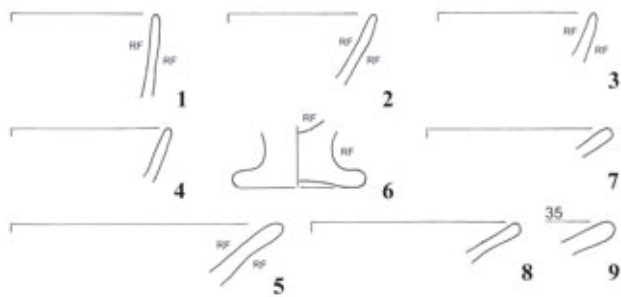

K8368

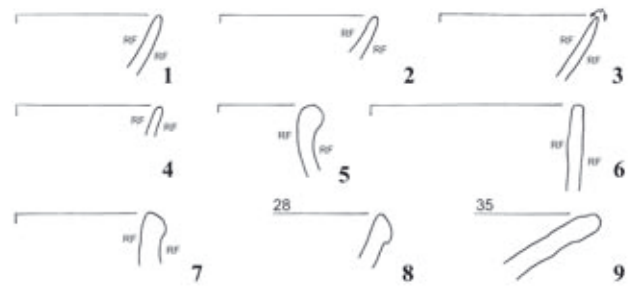

L586

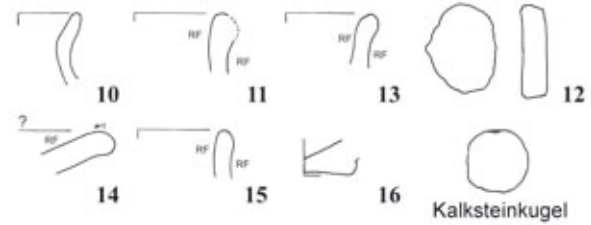



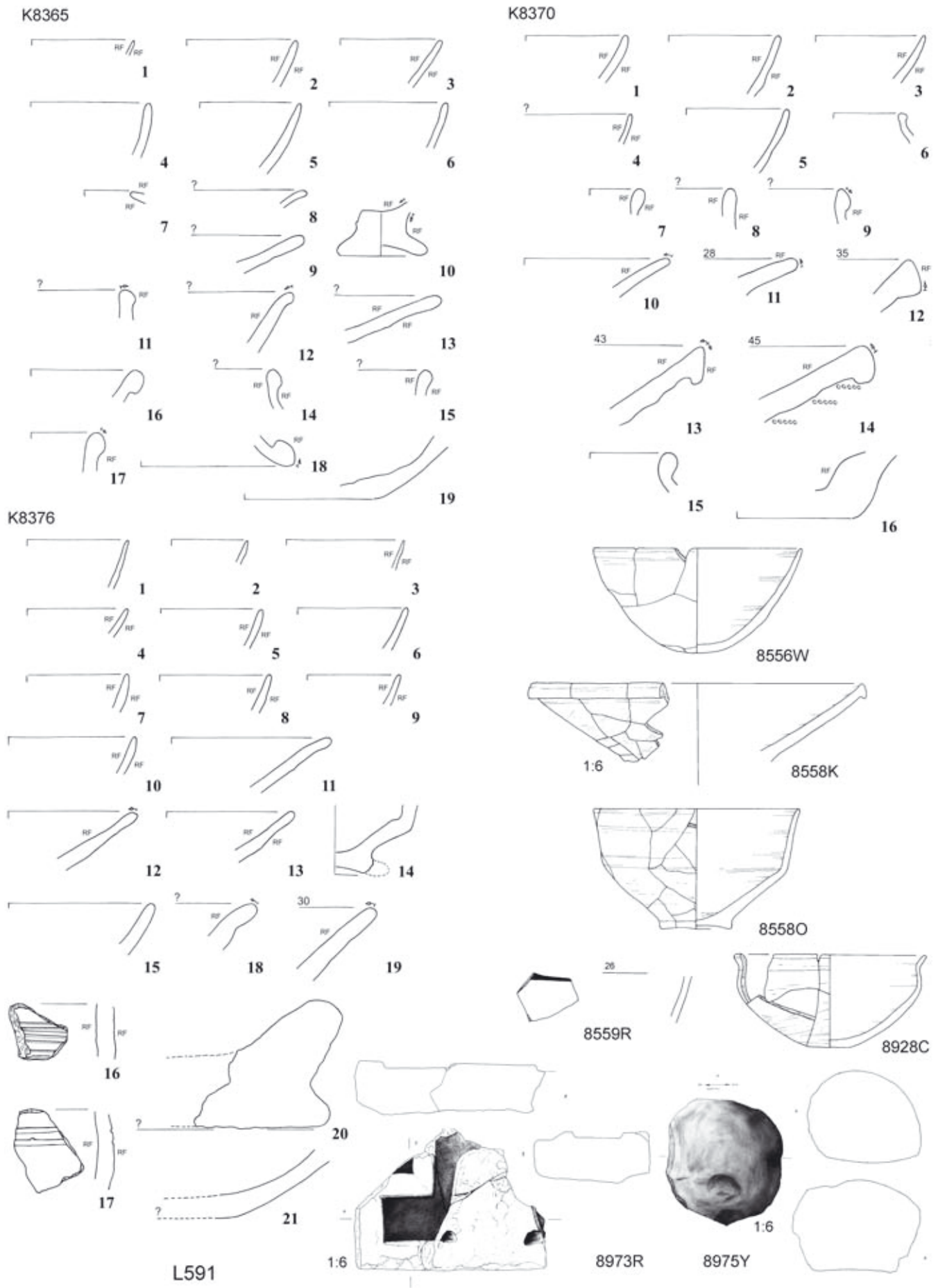

Tafel 133

(L595 nach o/59, Gru. 25: Taf. 183)

K8111

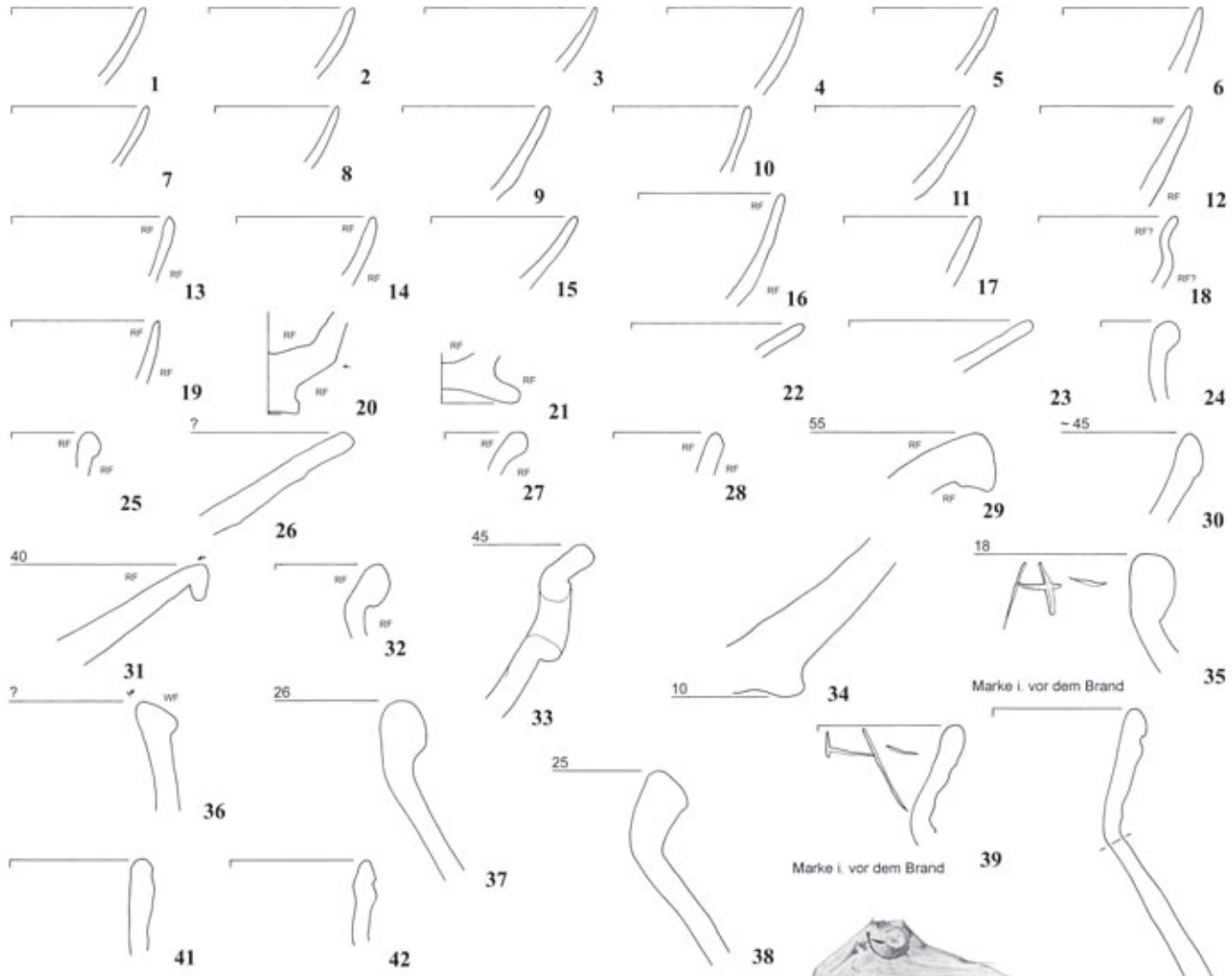

L596



8907L

40

K8112

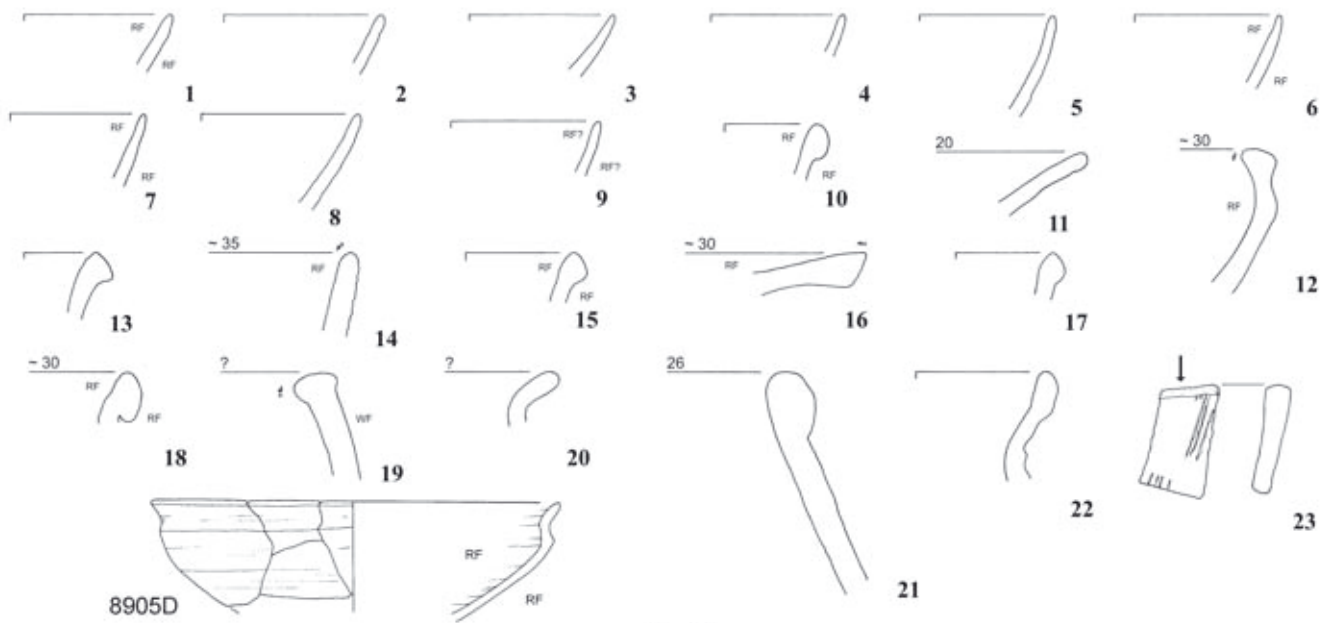

L597

K7999

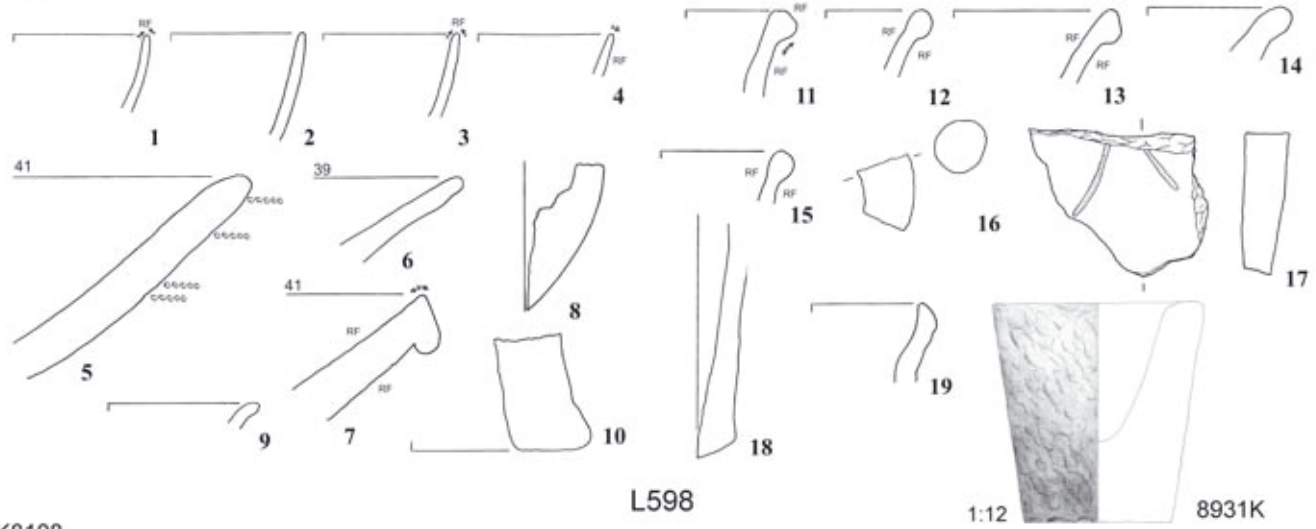

K8108

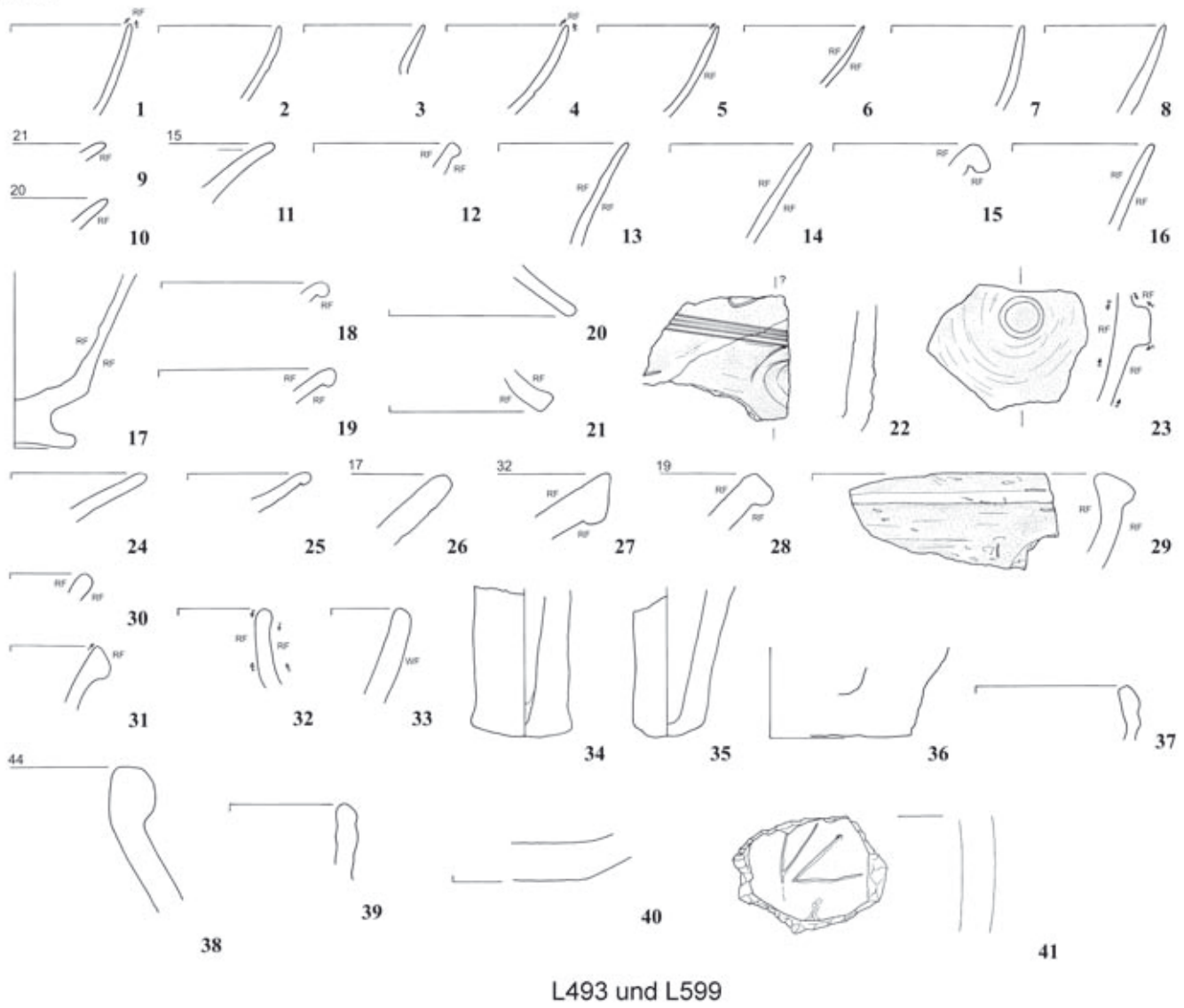

K7991

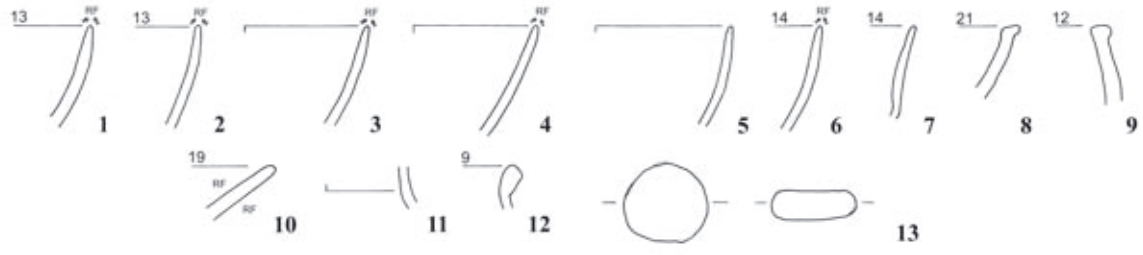

K7992

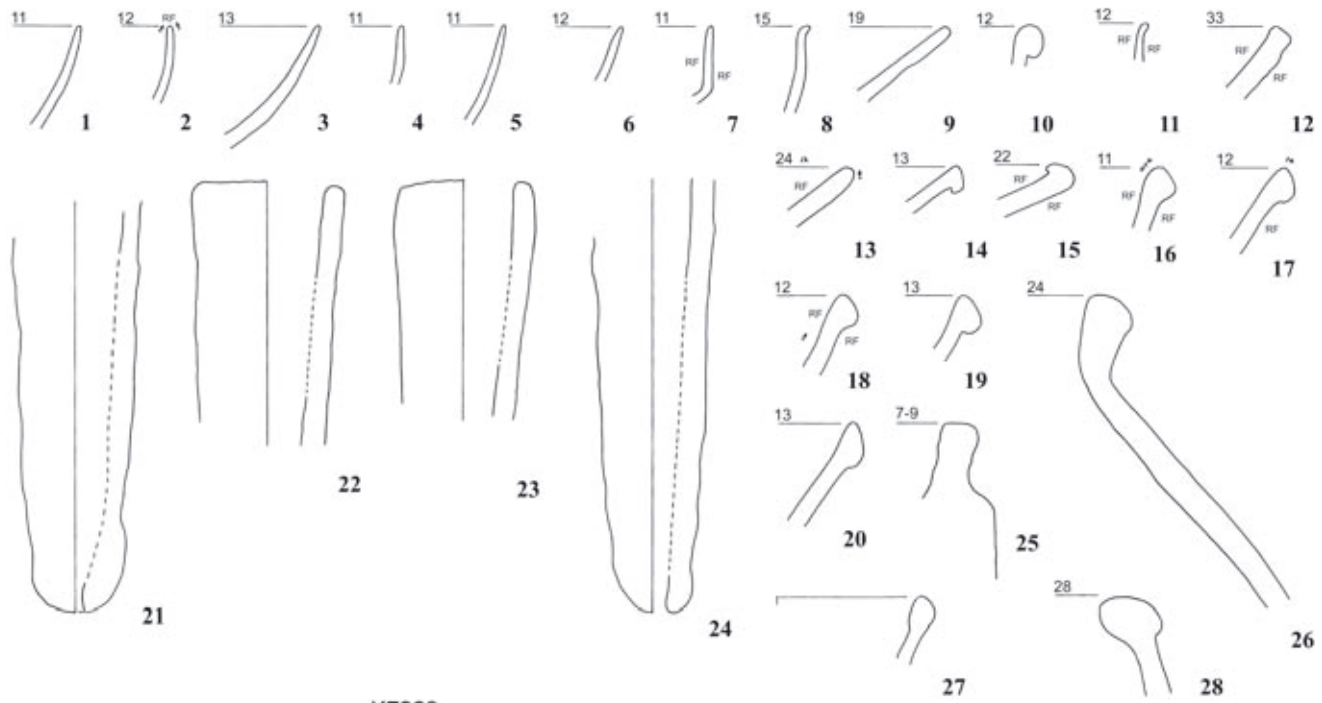

K7993

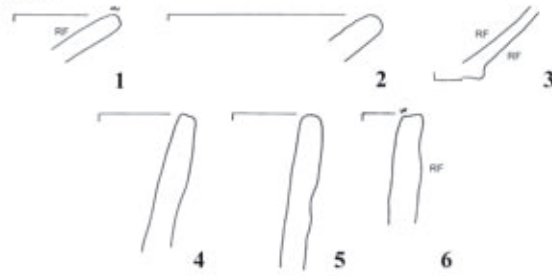

K7998

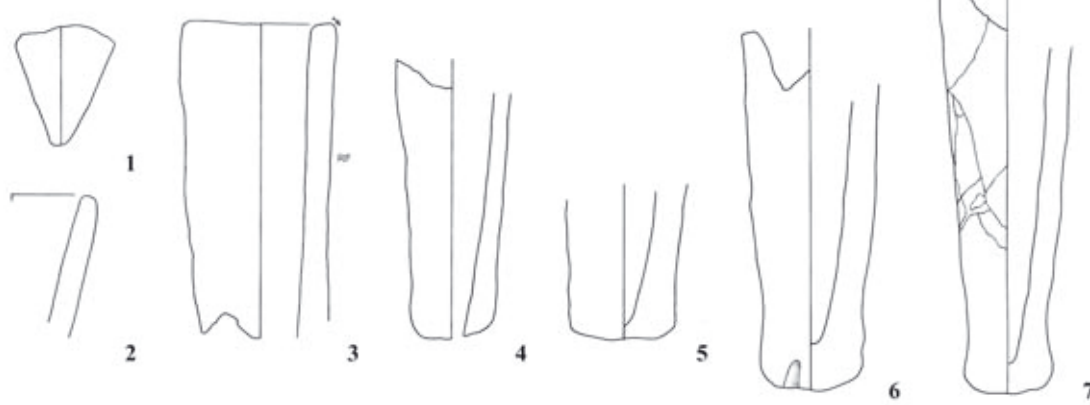

L601 (1)

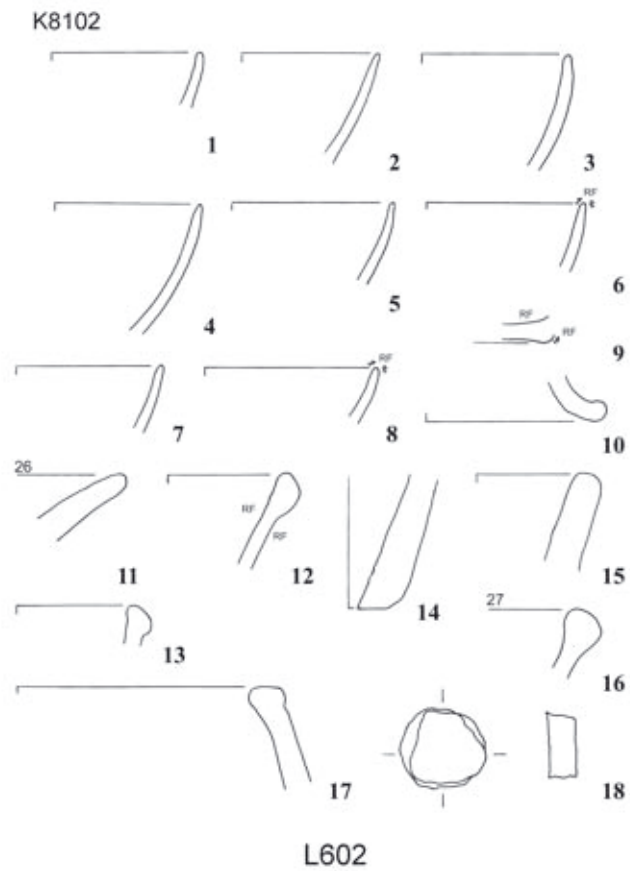
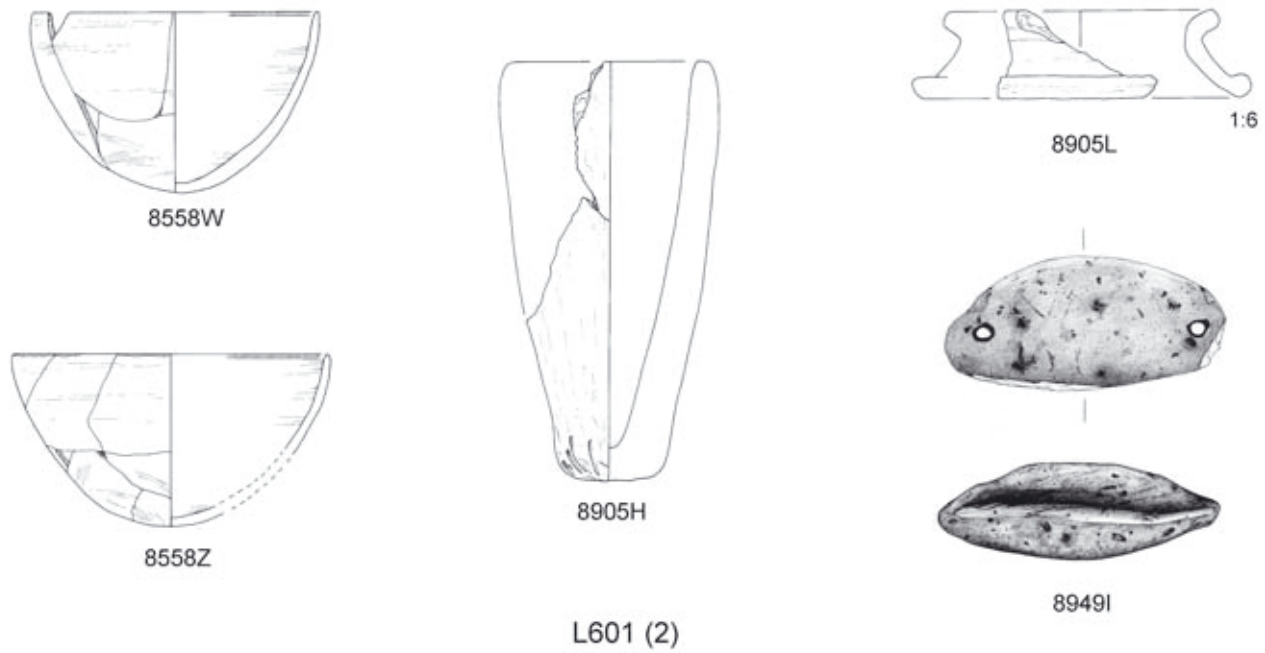



K7988

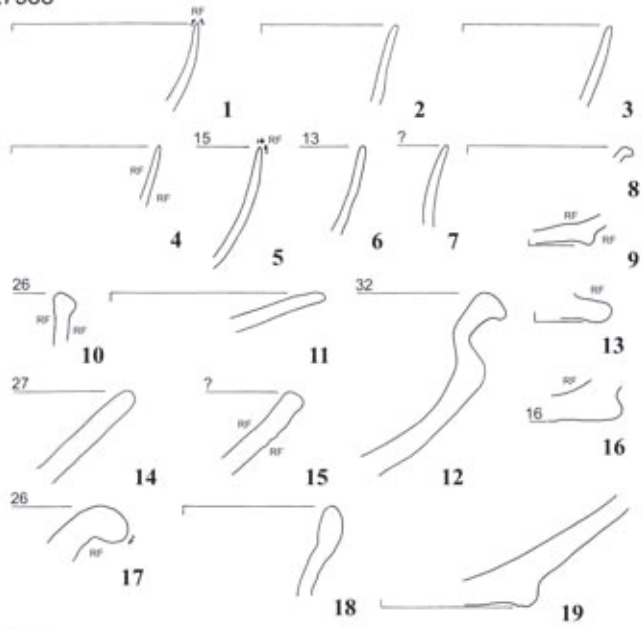

K8100

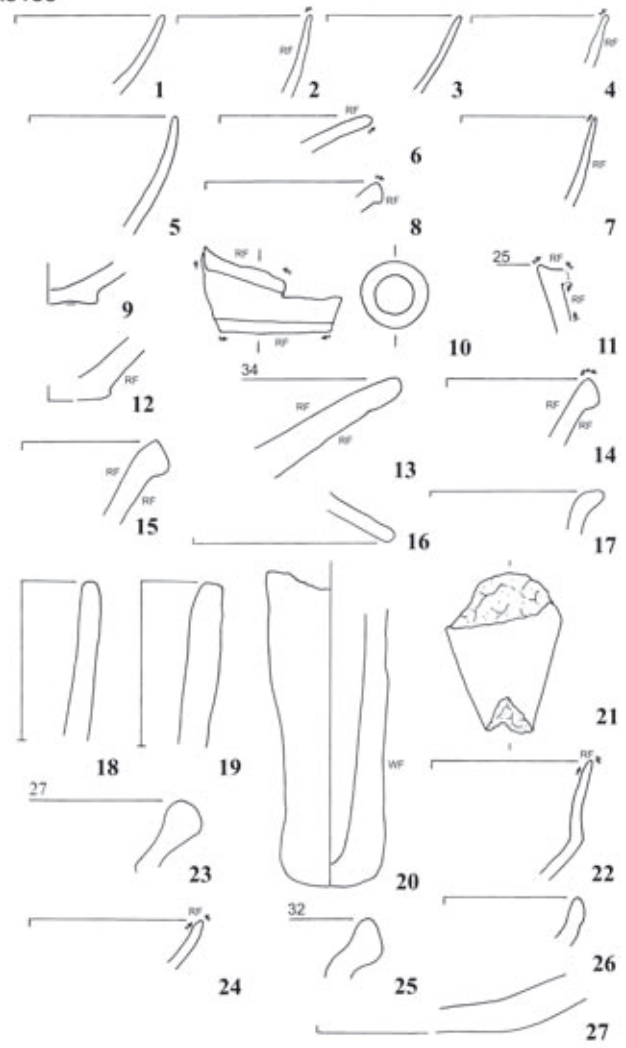

K7996

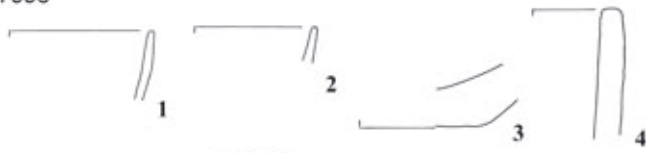

K7997

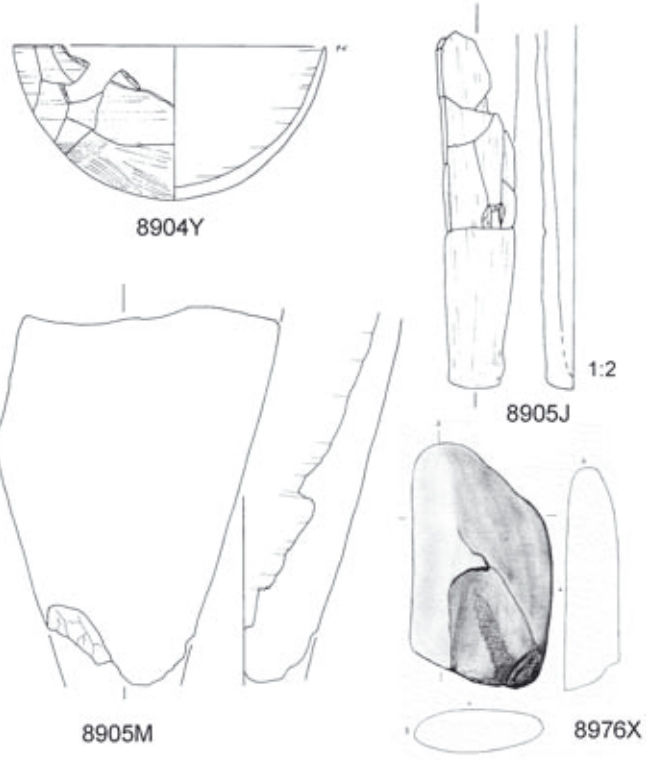
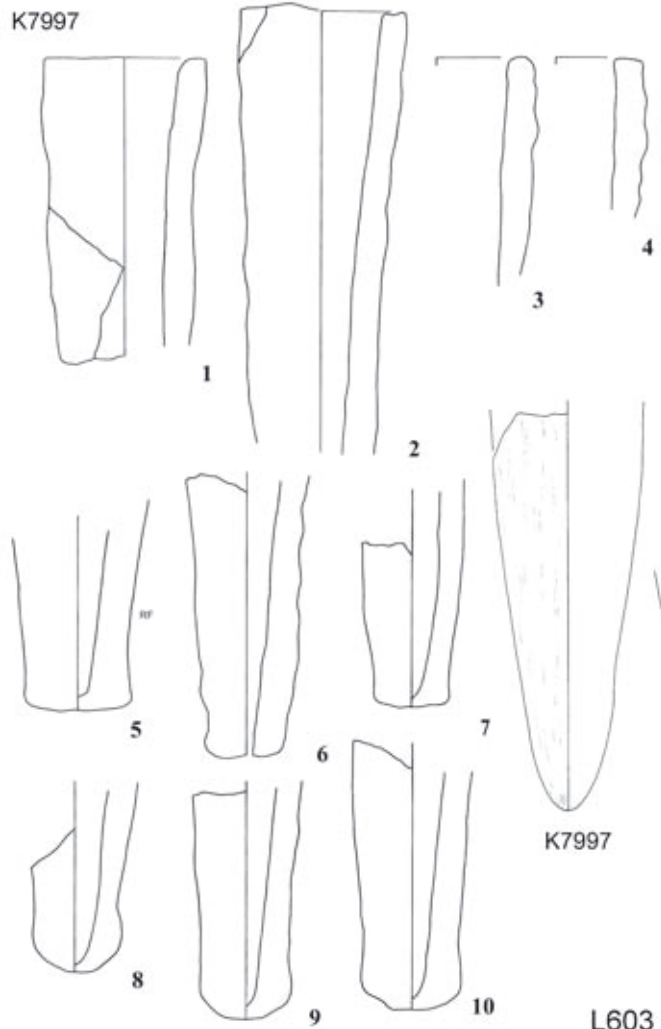

L603



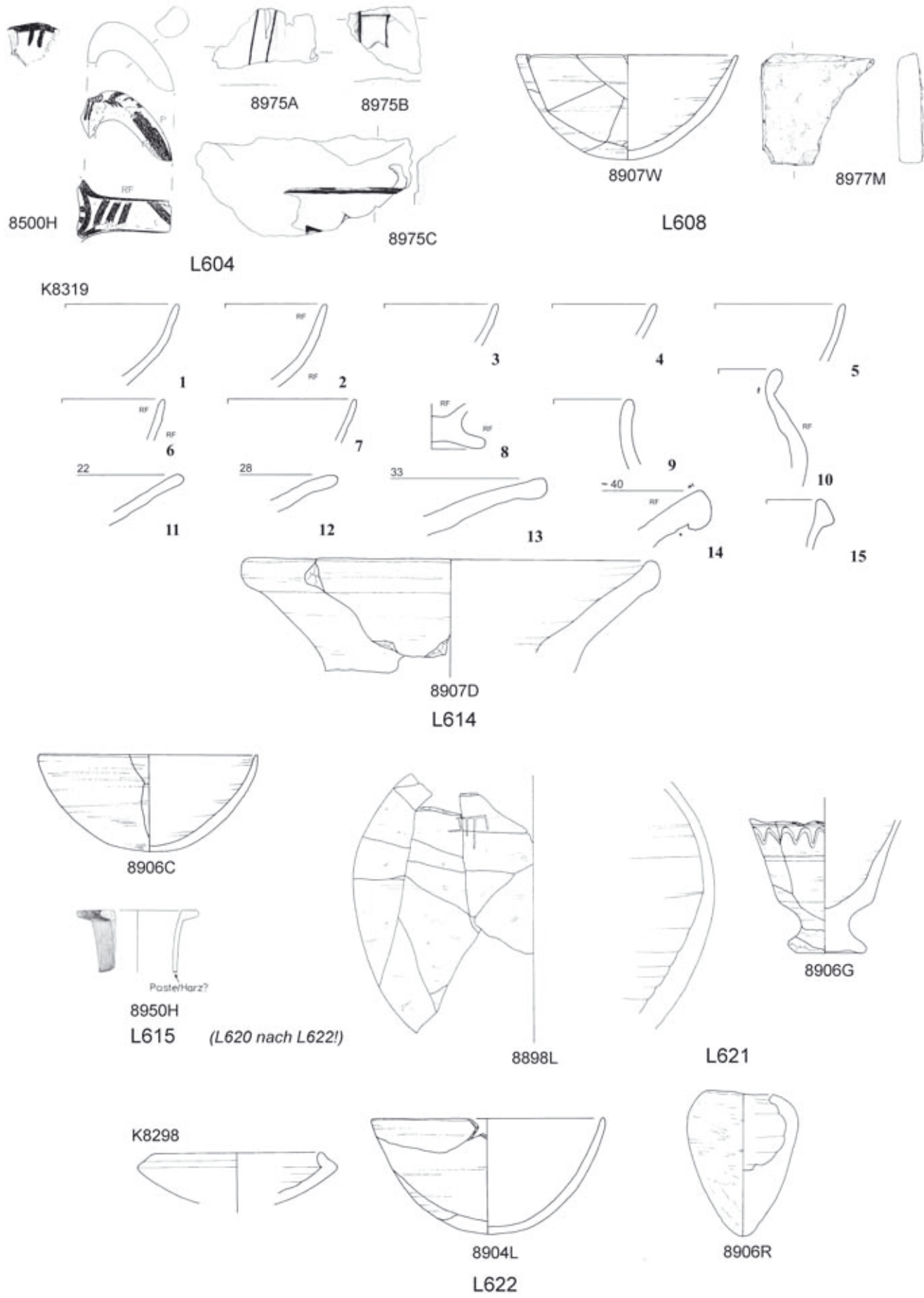

Tafel 139

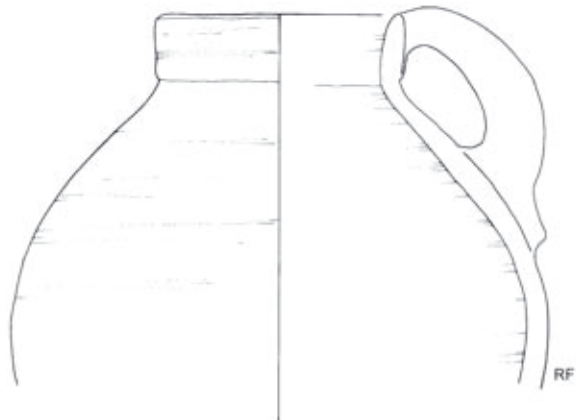

8907A  
L620

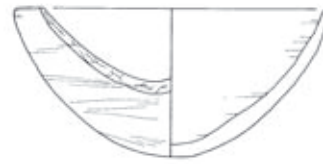

8906B



8907G  
L624



8885S  
L627



9057Y



L629

8915C

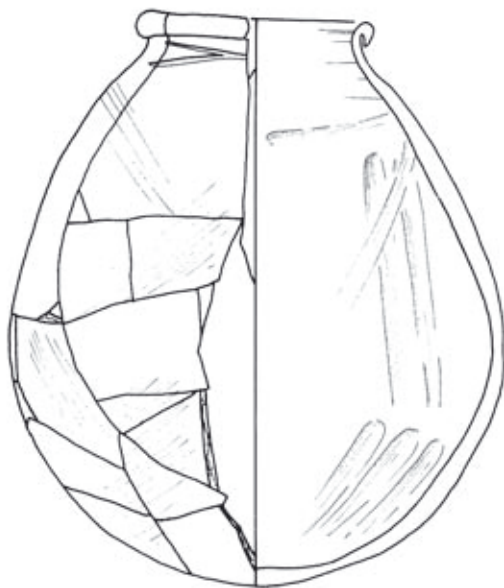

8564C  
L634



8887O  
L639

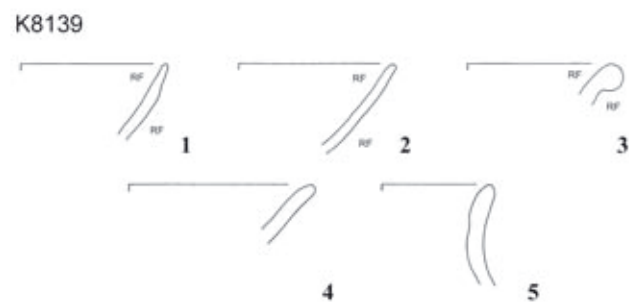
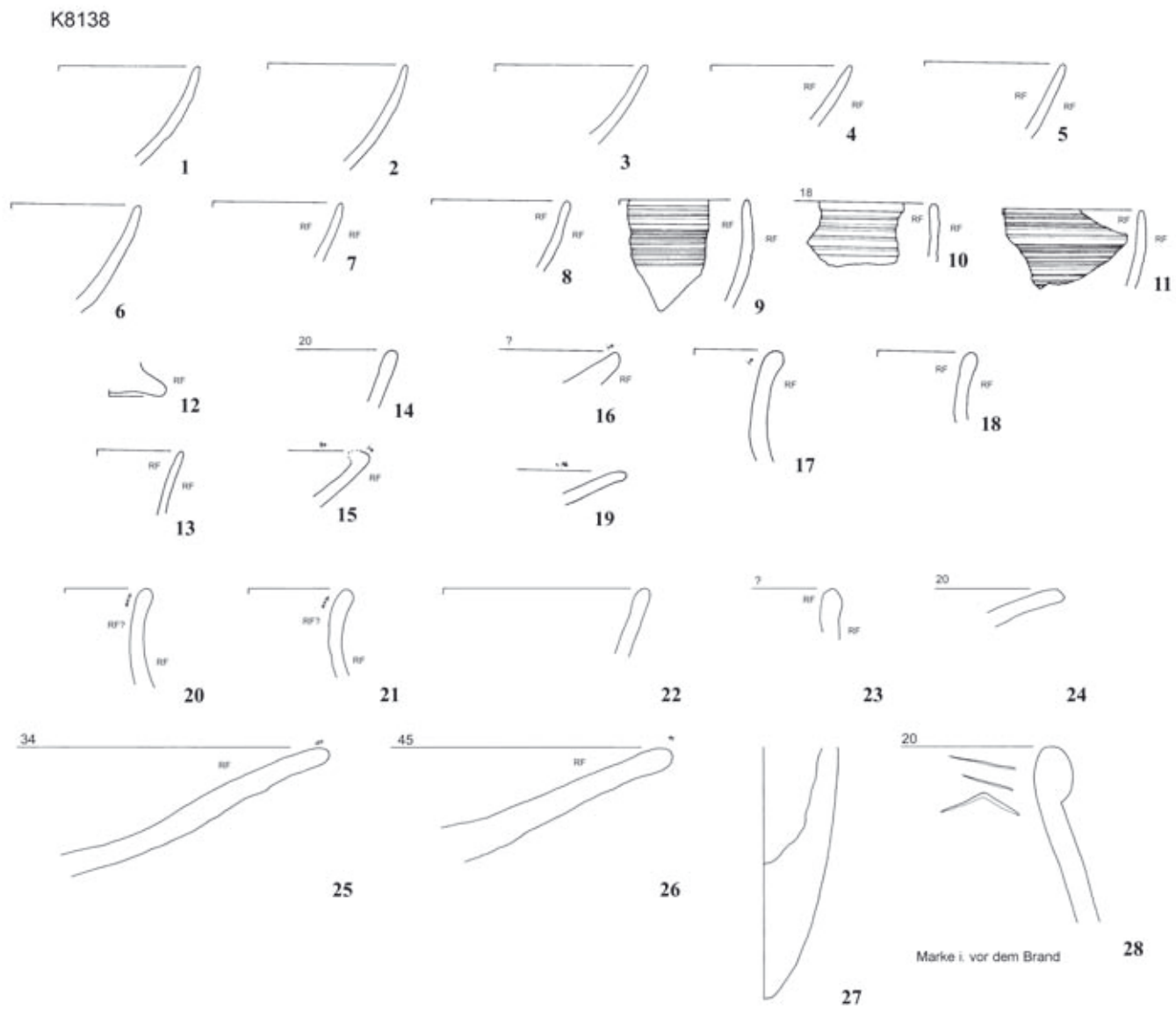

L647 (1)

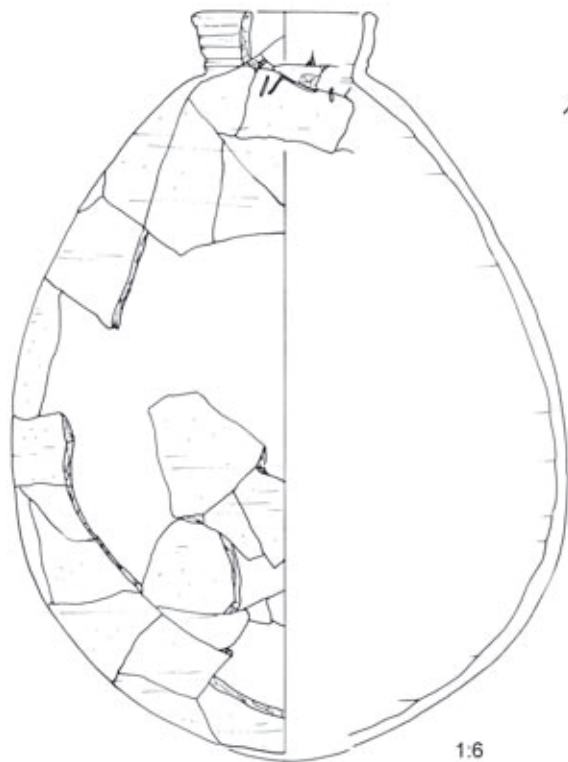

8559J

1.6



1.2

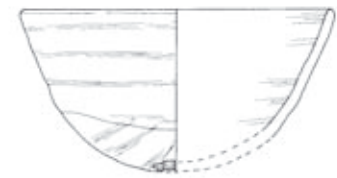

8588



8589



8590



8591

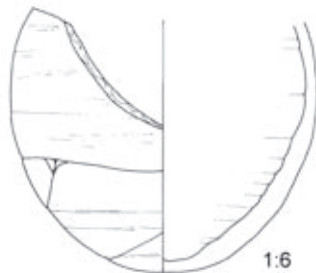

8892W

1.6

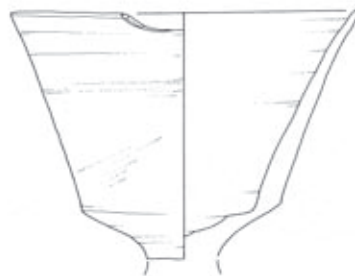

8888E

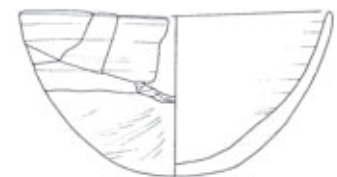

8888K

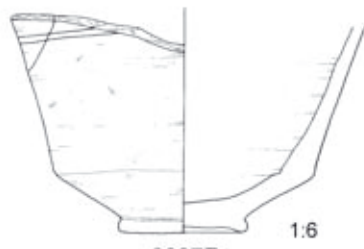

8897Z

1.6



8913F

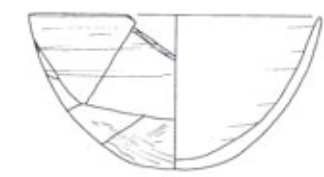

8888L

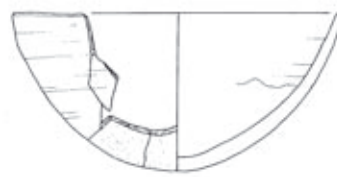

8888M

L647 (2)

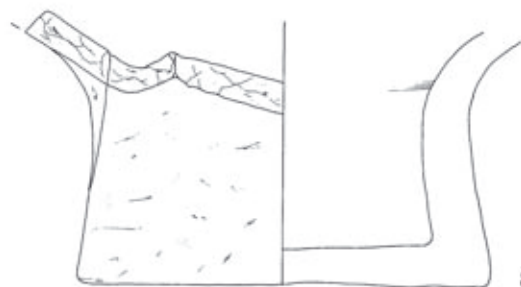

8898D



8913J

K7569

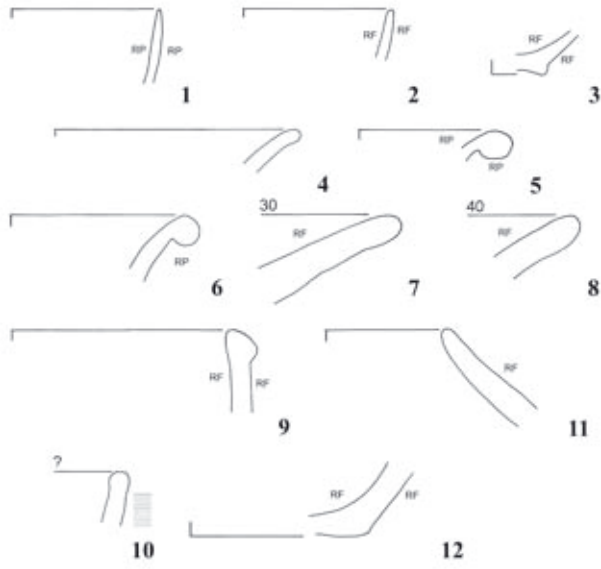

L649

K7575

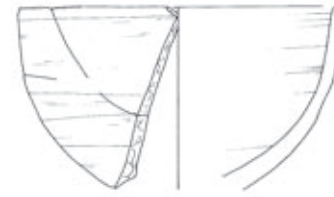

8887Y  
L650

K8346

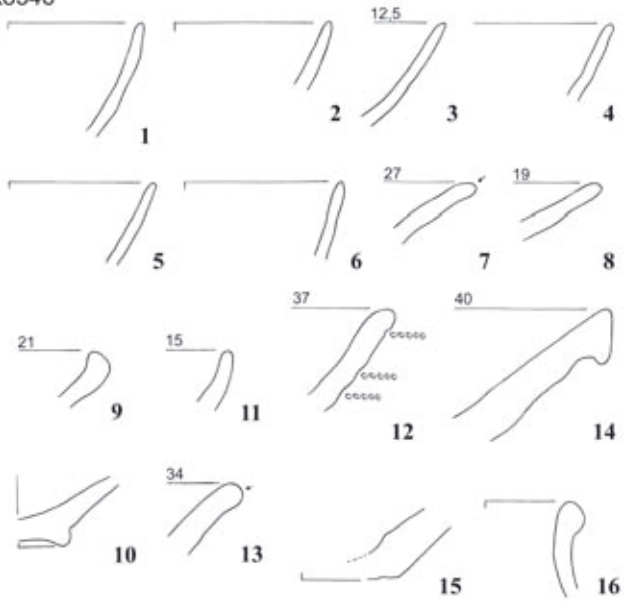

L653

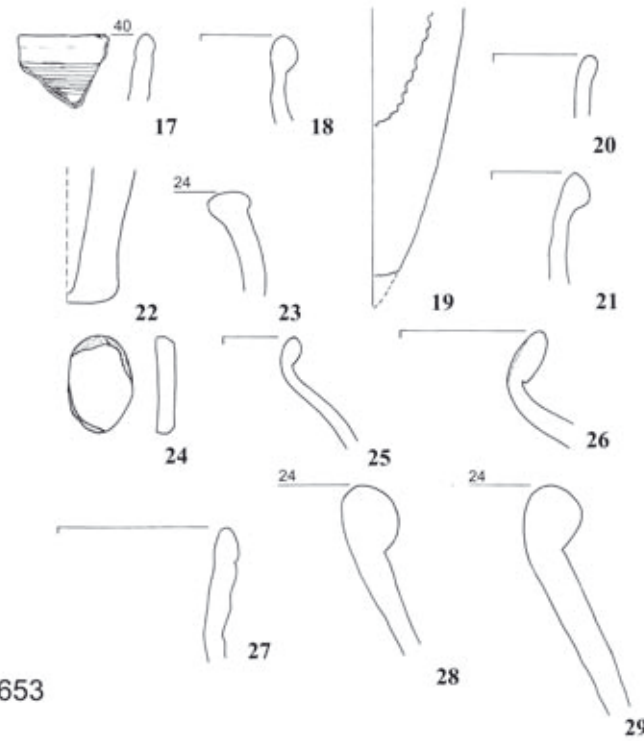

K7987

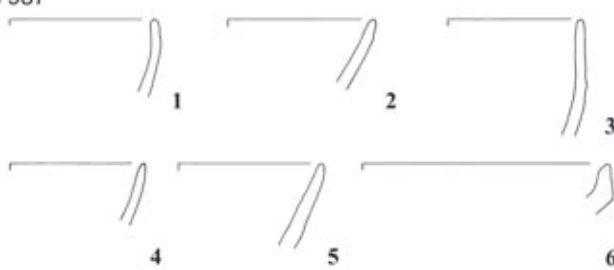

L654

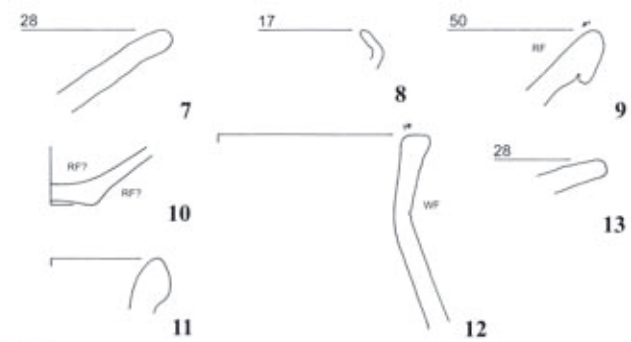

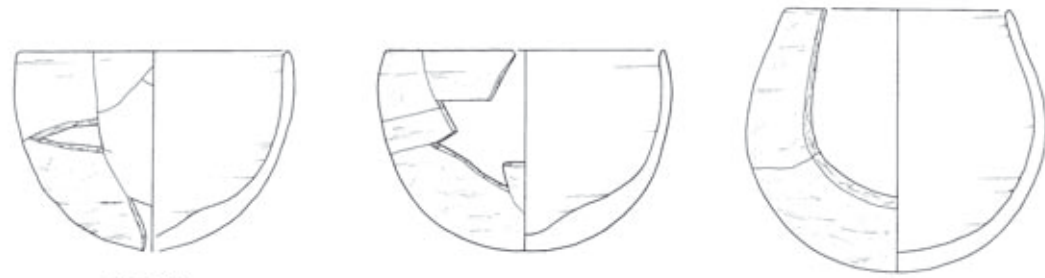

8565O

8565P

8565N

K8423/24

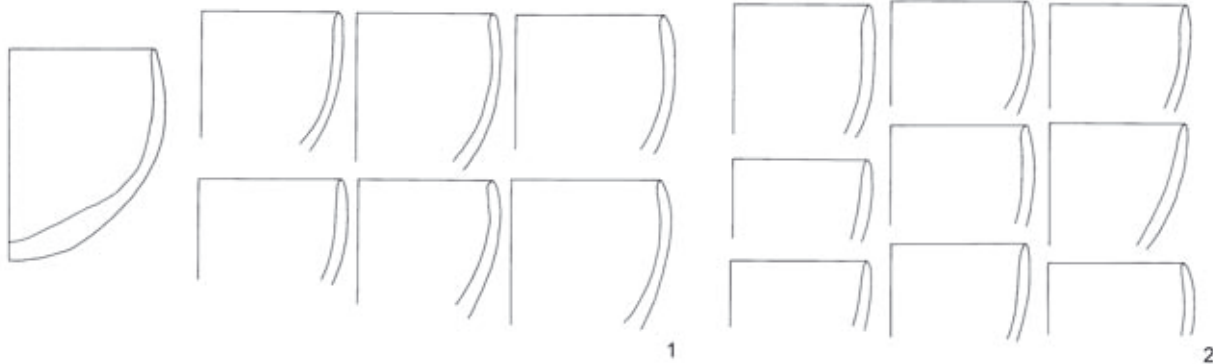

1

2



3

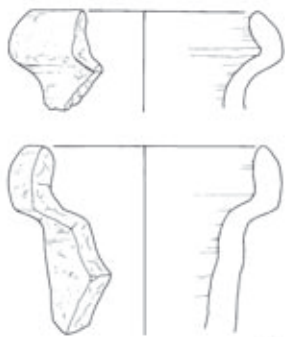

4

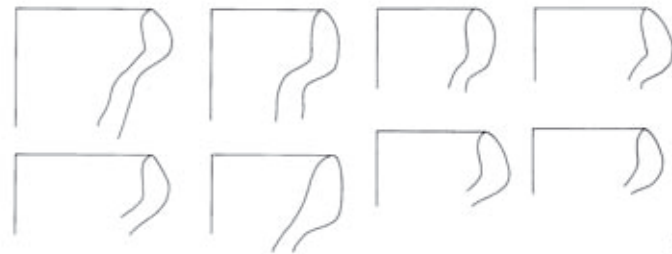

5



6



7



8

j/61, Gru. 2 (nach *Ä&L* 11, 19, Abb. 3)



K8423/24

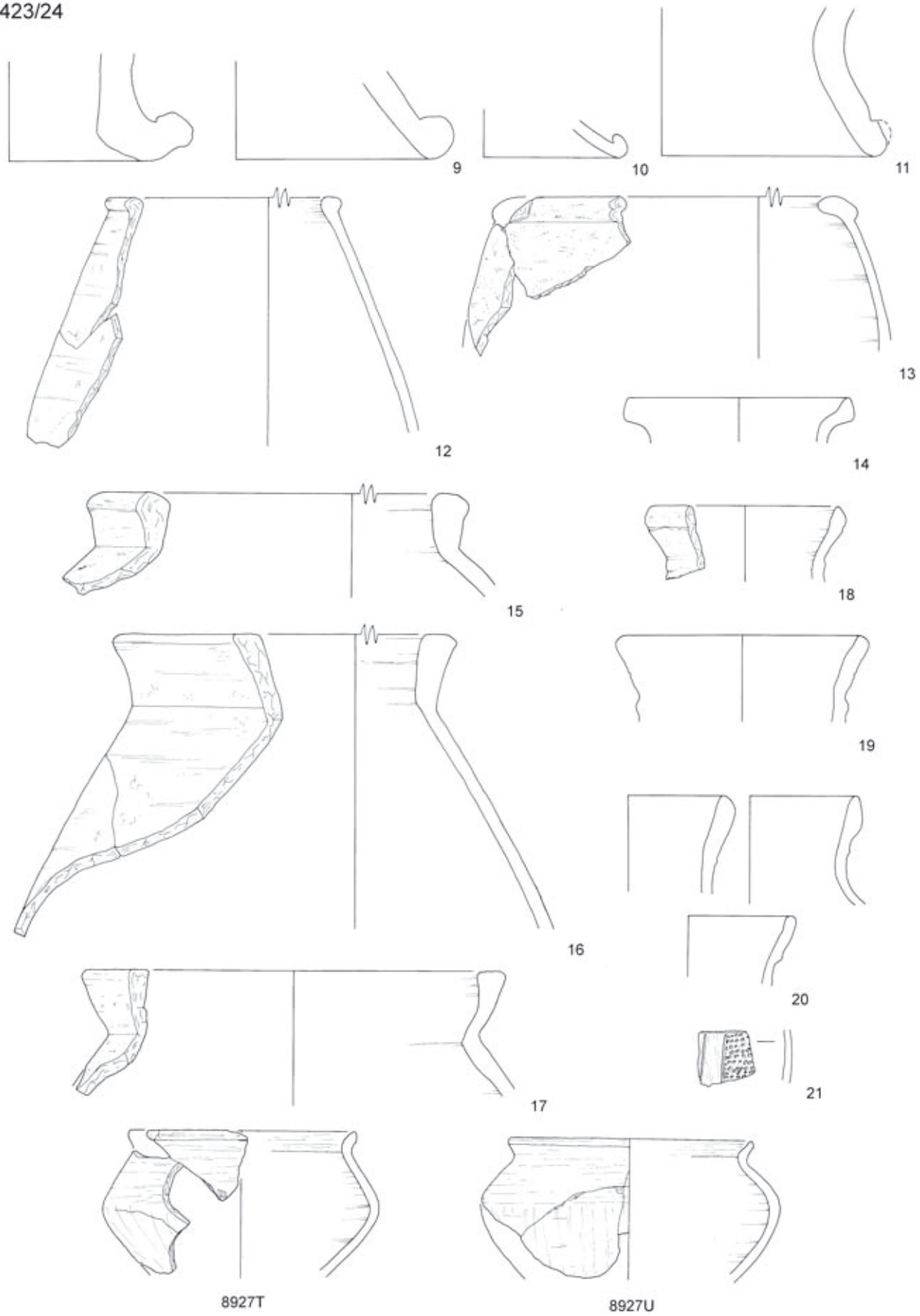

j/61, Gru. 2 (nach *Ä&L* II, 19, Abb. 4)

Tafel 145

K8422

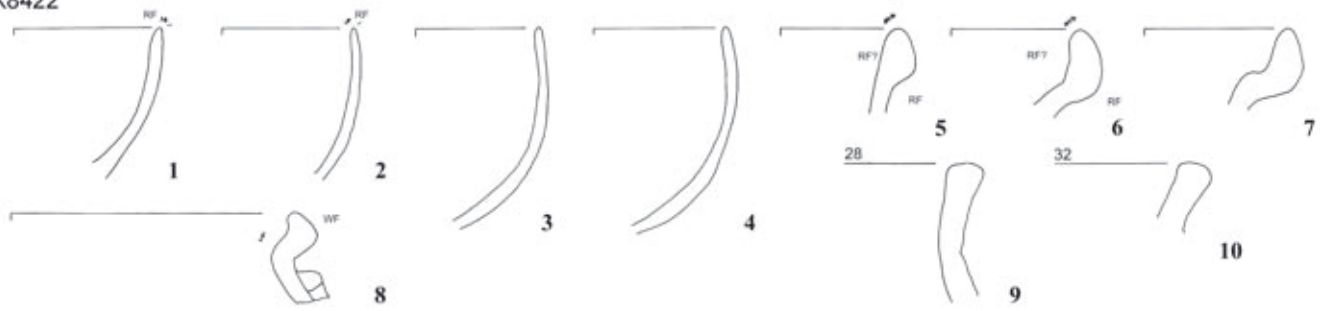

zu K8424

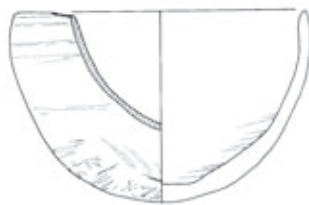
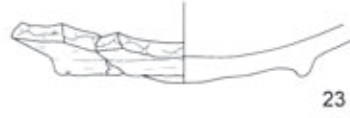
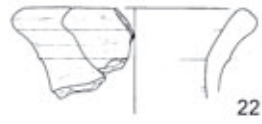

8554Q



8554P



8554R

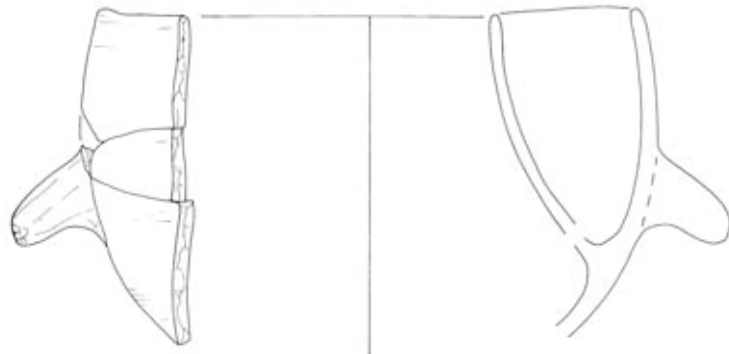

8565Y

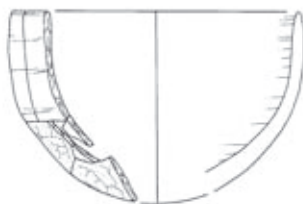

8554X

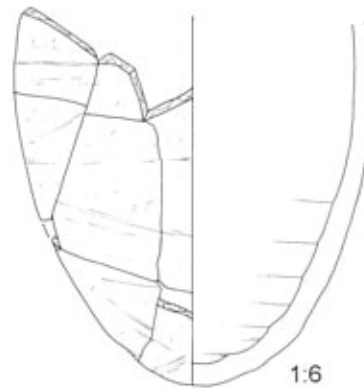

1:6

8892V

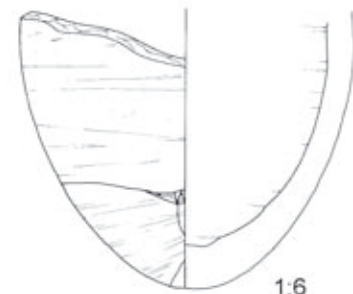

1:6

8892Y



8929

1:1

j/61, Gru. 2

Tafel 146

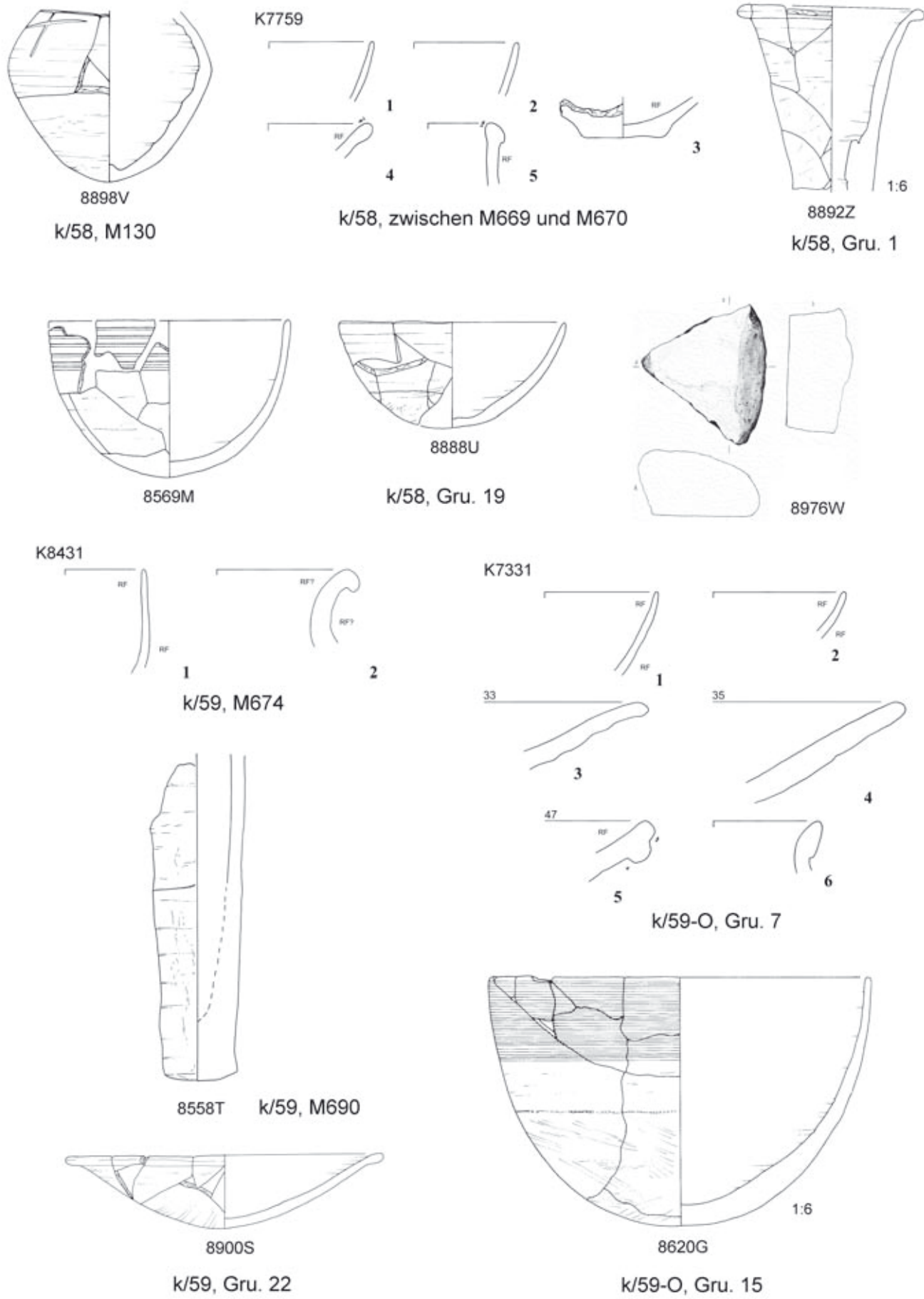

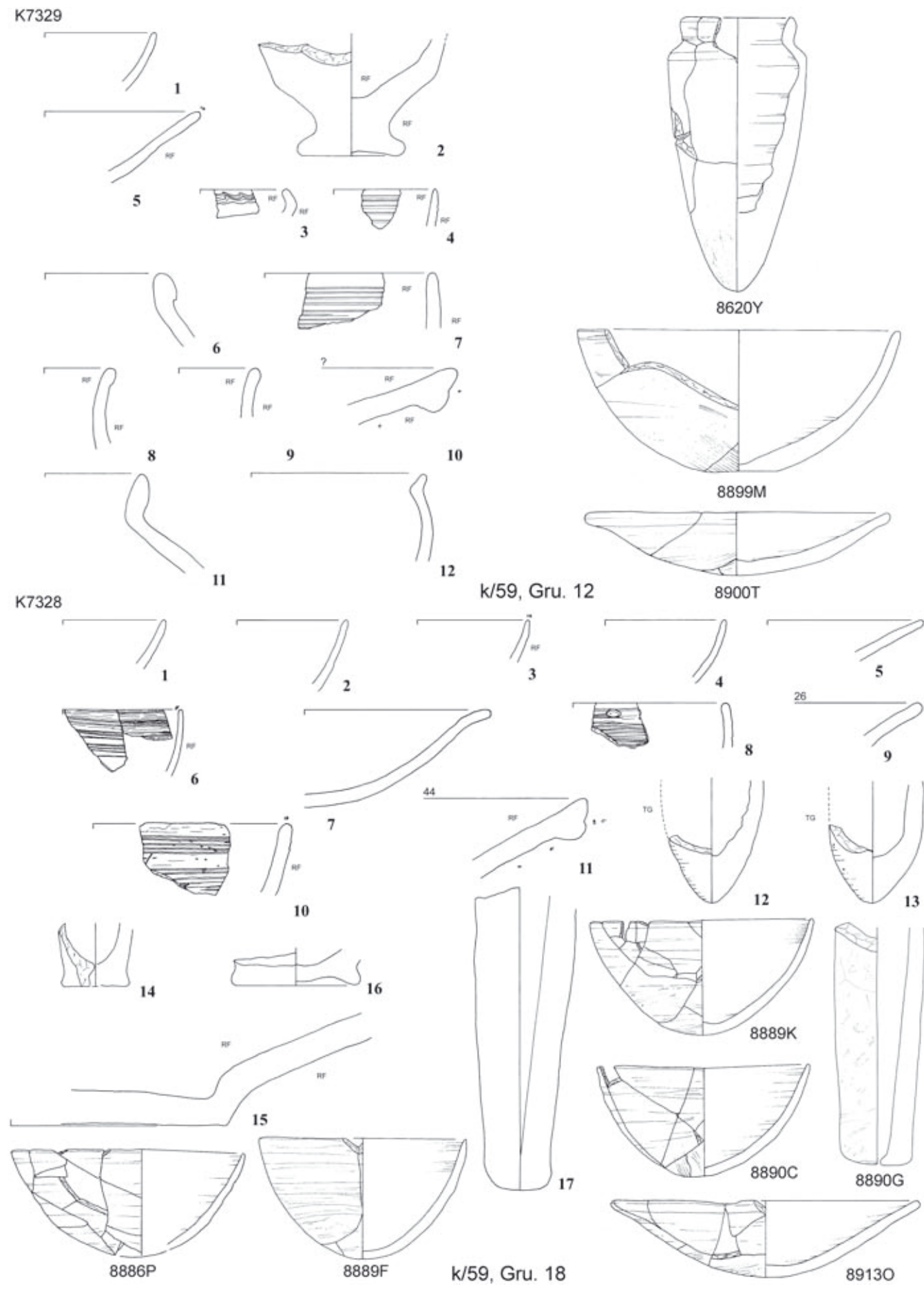

Tafel 148

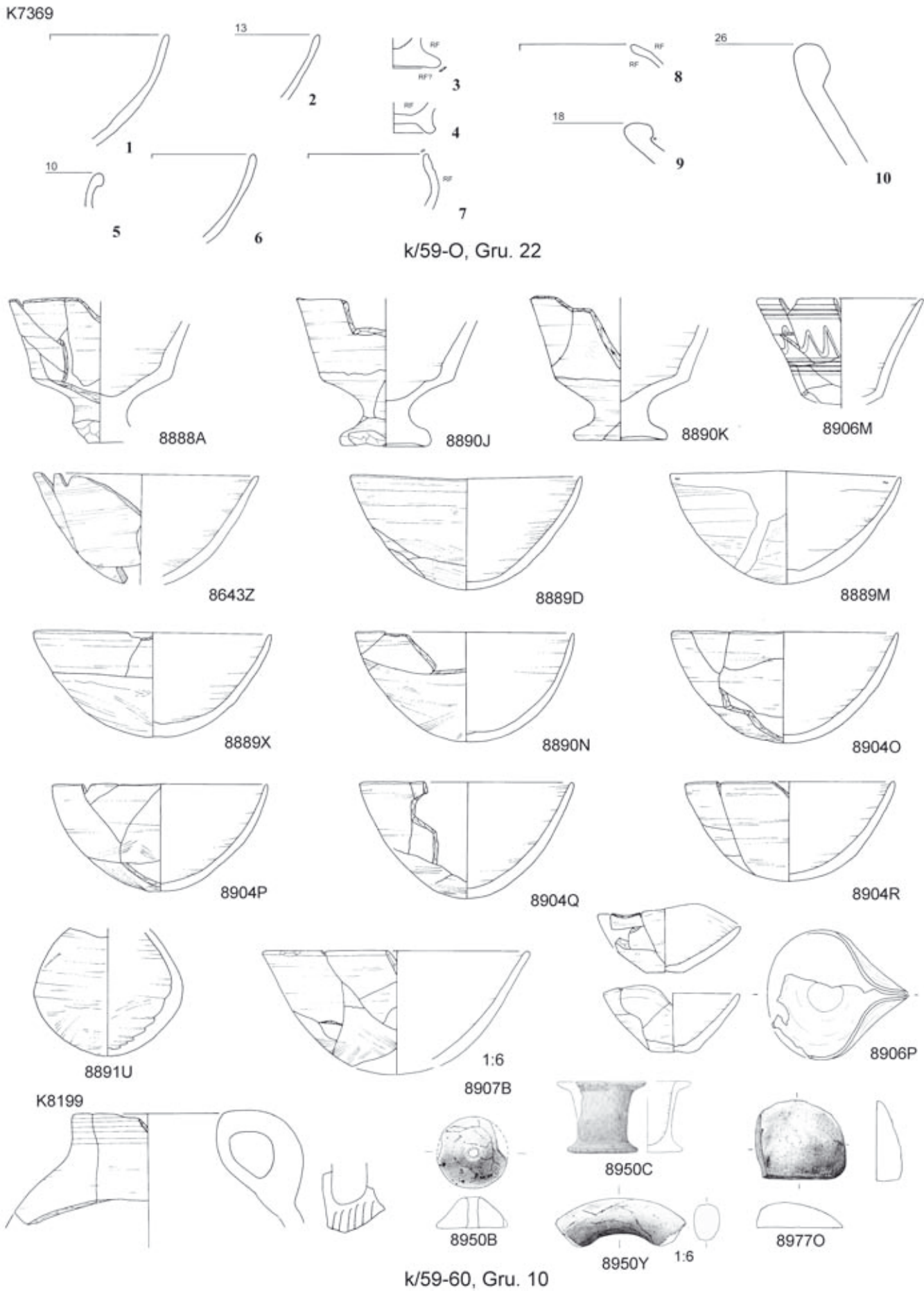



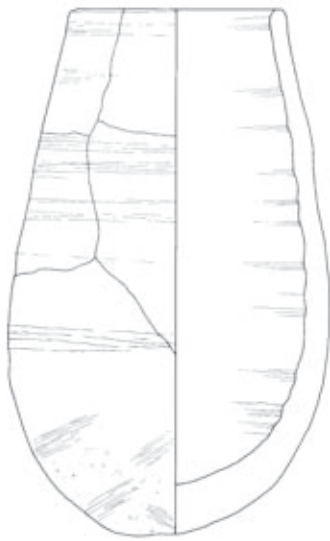

8606



8607

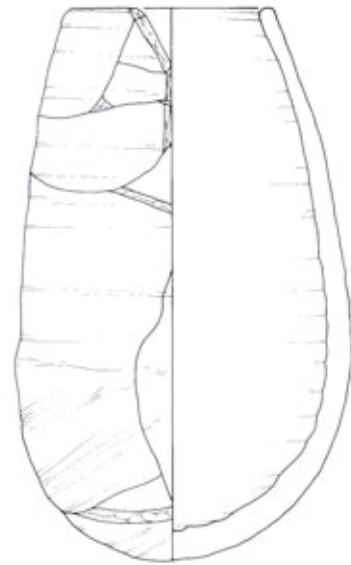

8900I

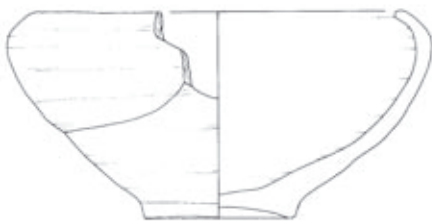

8906W

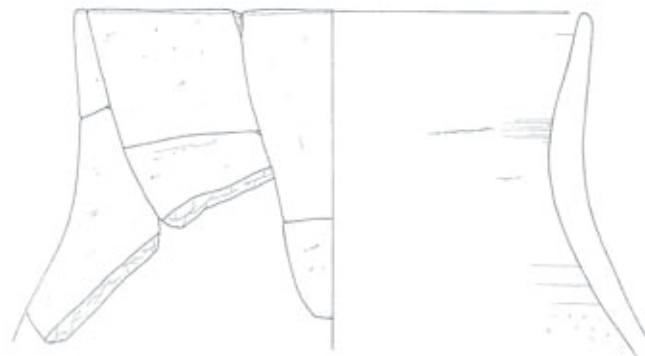

8900R



8906X

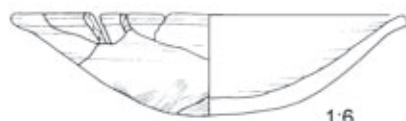

8907C



8620E

k/60, Gru. 6 (s. L247)



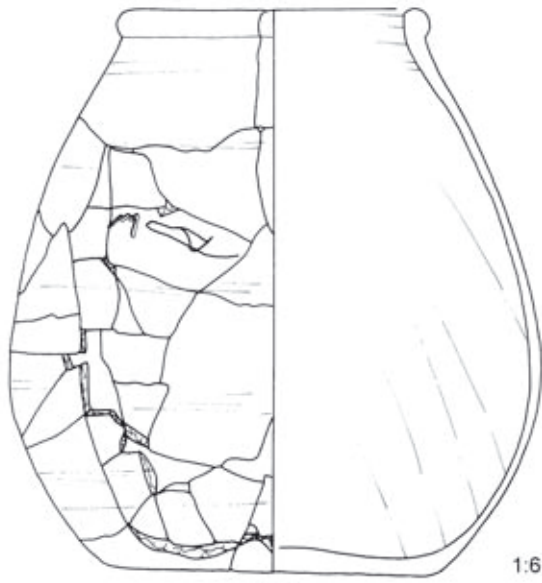

8618  
k/60, Gru. 14

K8246

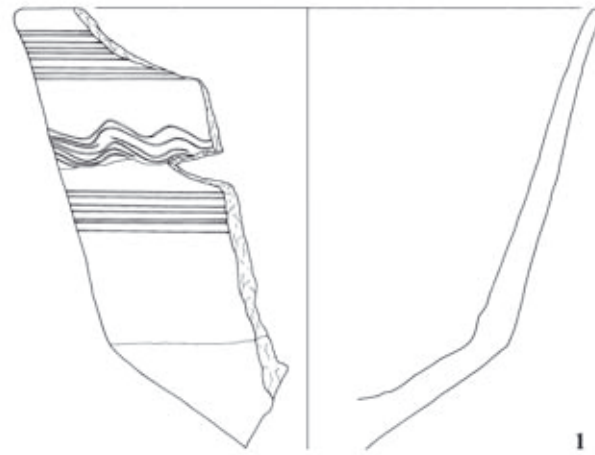

k/61, Profilgräben

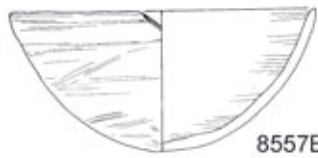

k/61, M618, Fgr.

K8238

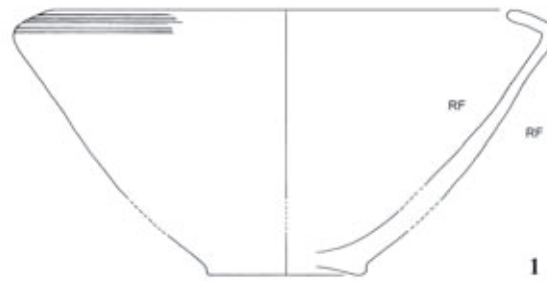

k/61, M144a

K8208

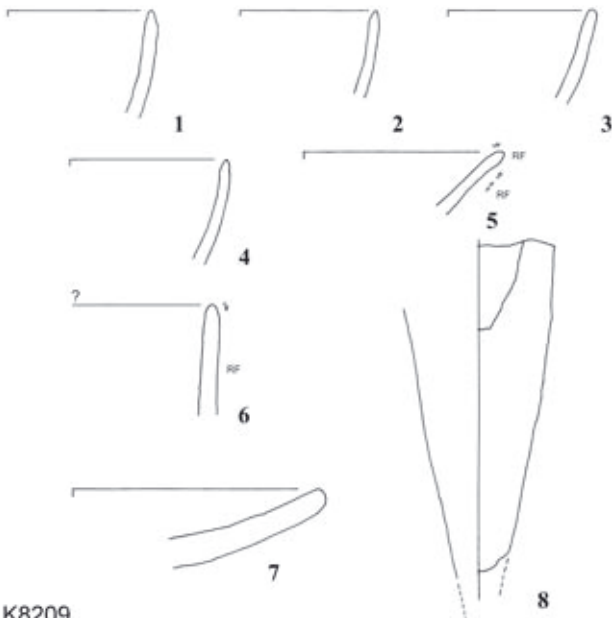

K8209

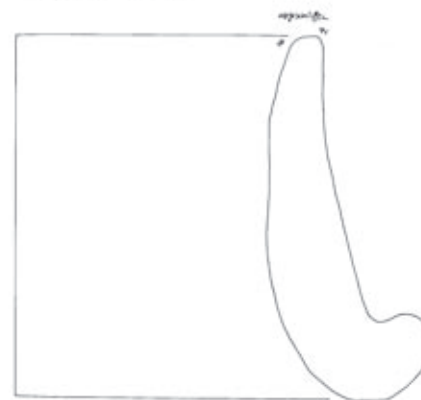
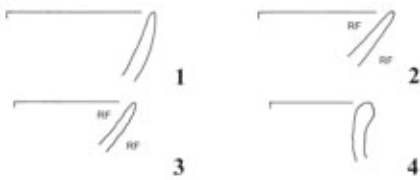

8569T/1

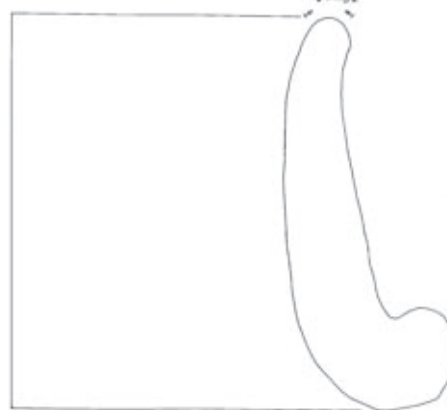

8569T/2

k/61, Gru. 1

Tafel 151

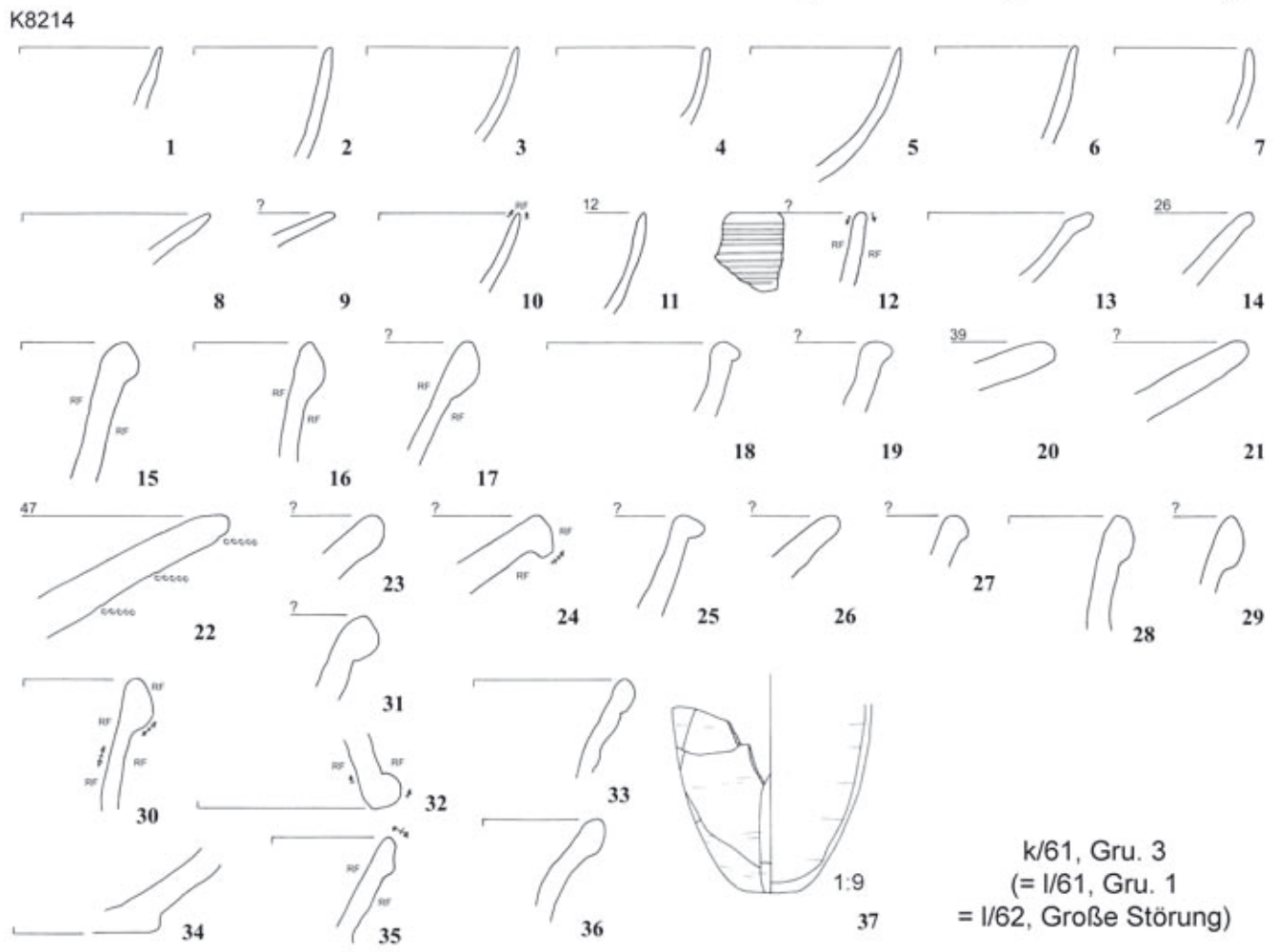
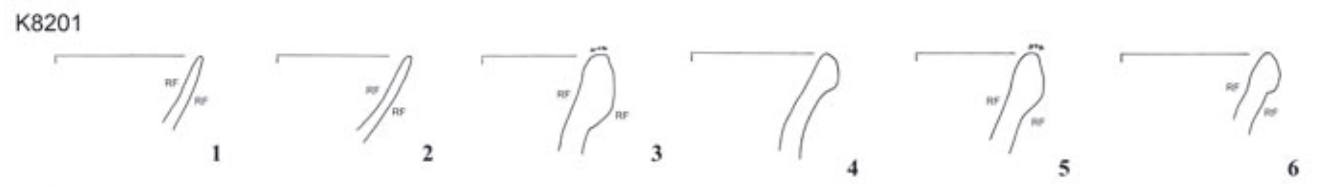
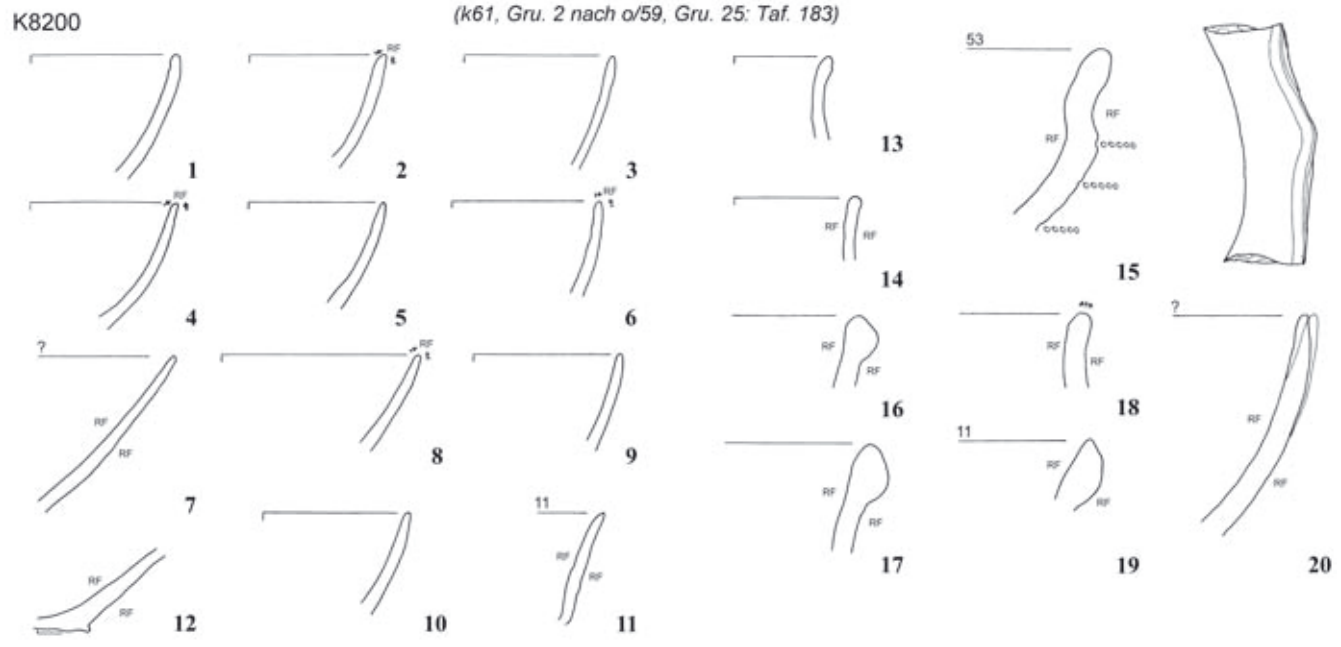

K8205

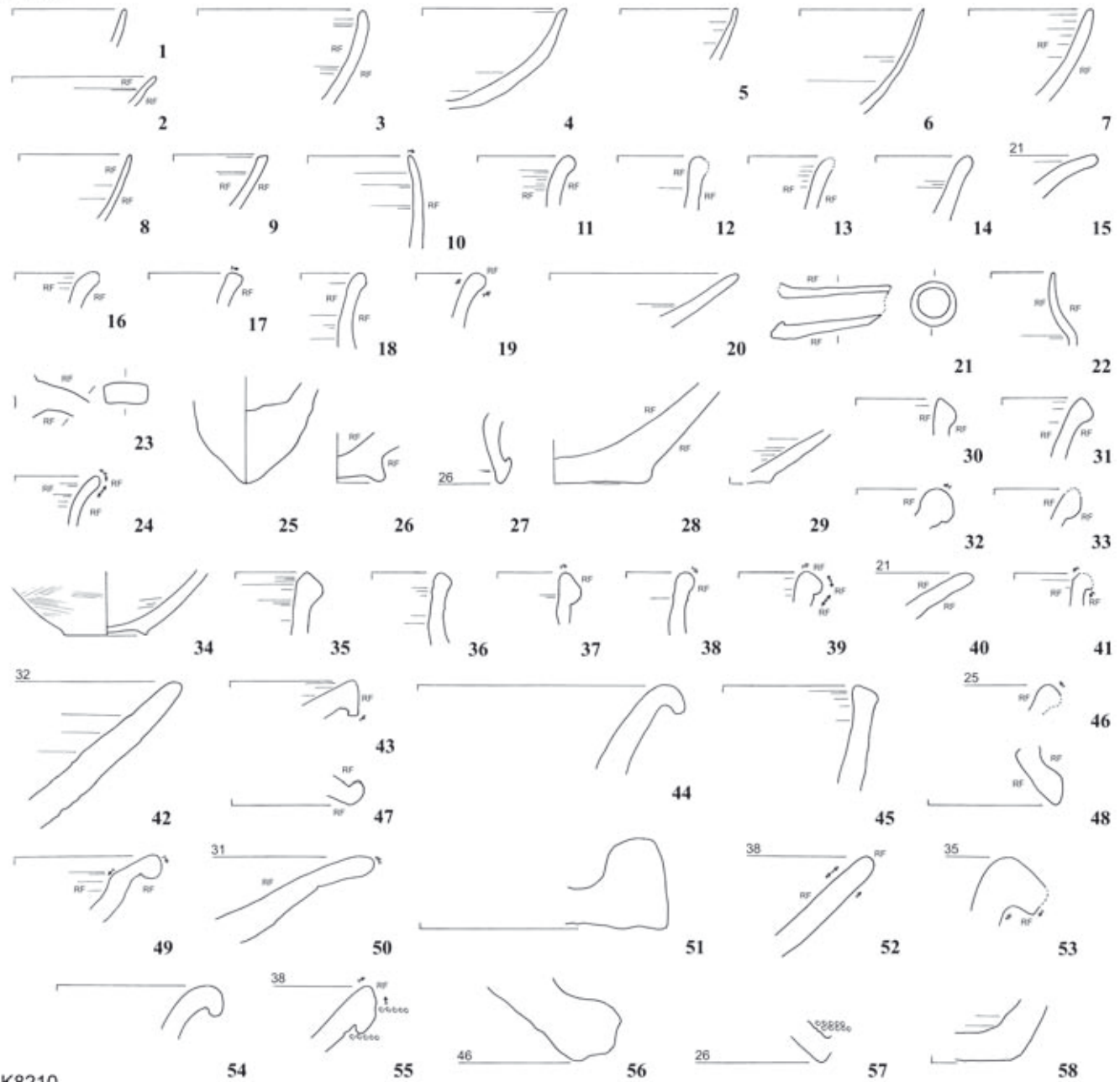

K8210

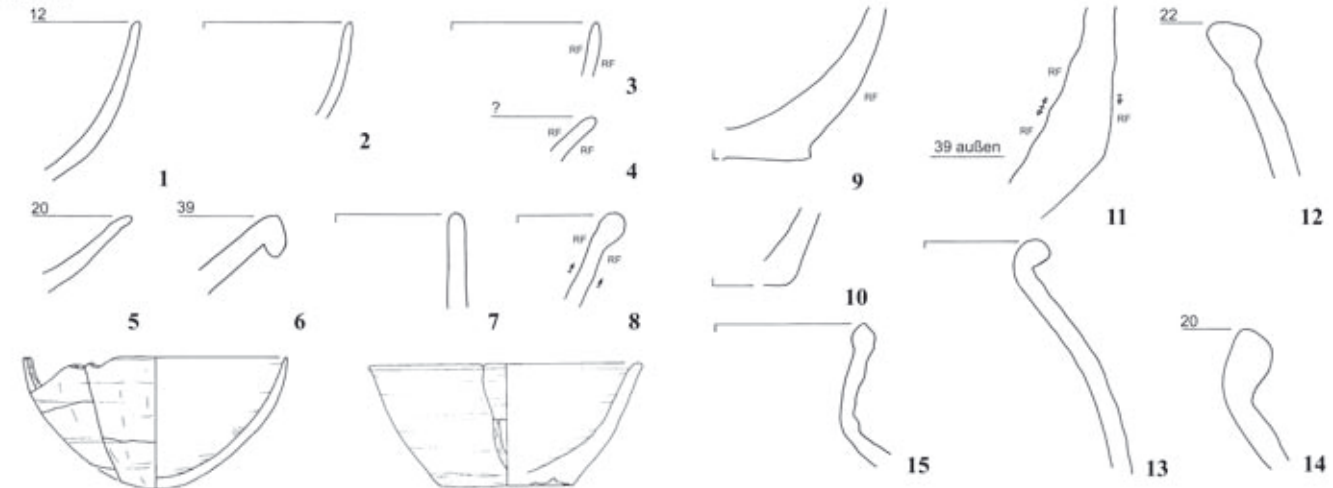

k/61, Gru. 4

K8226

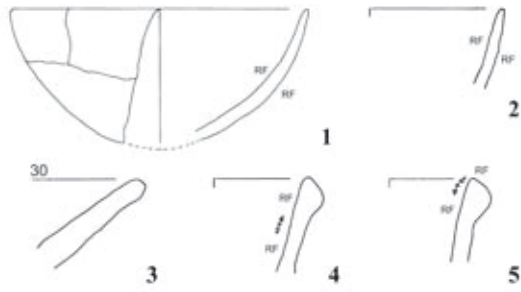

k/61, Gru. 11



8907V

I/59, M678/679/680

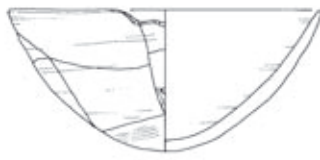

8906D

I/61, M153/156

K8285



I/61, M166

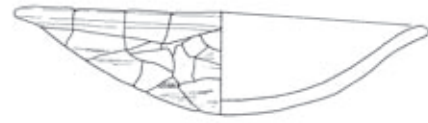

8892Q

I/61, M182

K8288

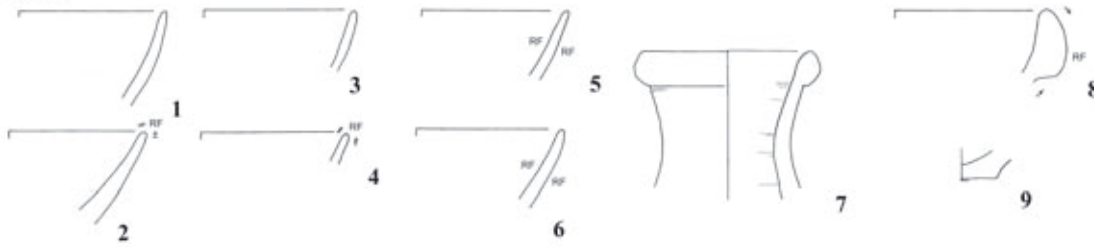

I/61, U1

(I/61, Gru. 1 nach I/61, Gru. 31: Taf. 157)

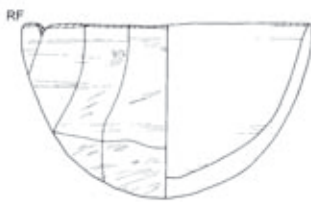

8897G

I/61, Gru. 9



8906S

I/61, Gru. 10

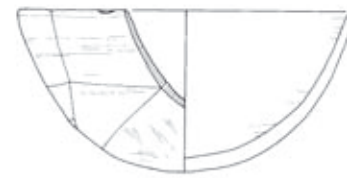

8897H

I/61, Gru. 13

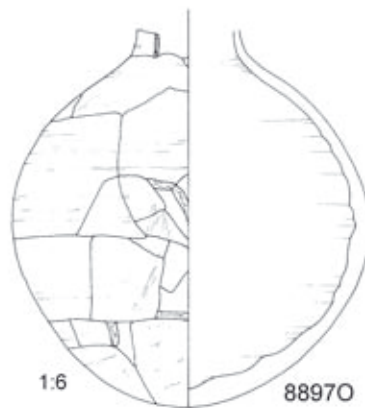

8897O

I/61, Gru. 22

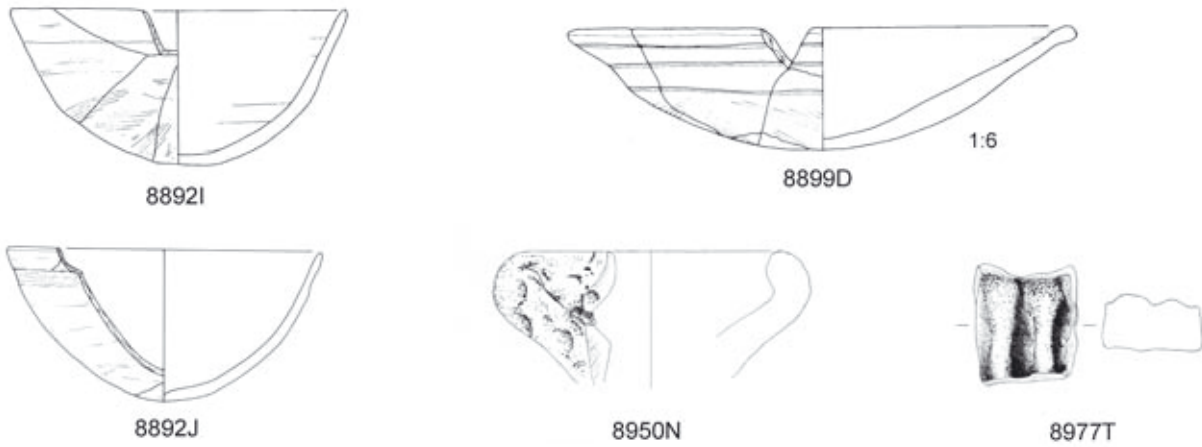

I/61, Gru. 23

I/61, Gru. 31 nach I/61, Gru. 35-40; 43: Taf. 156)

K8322

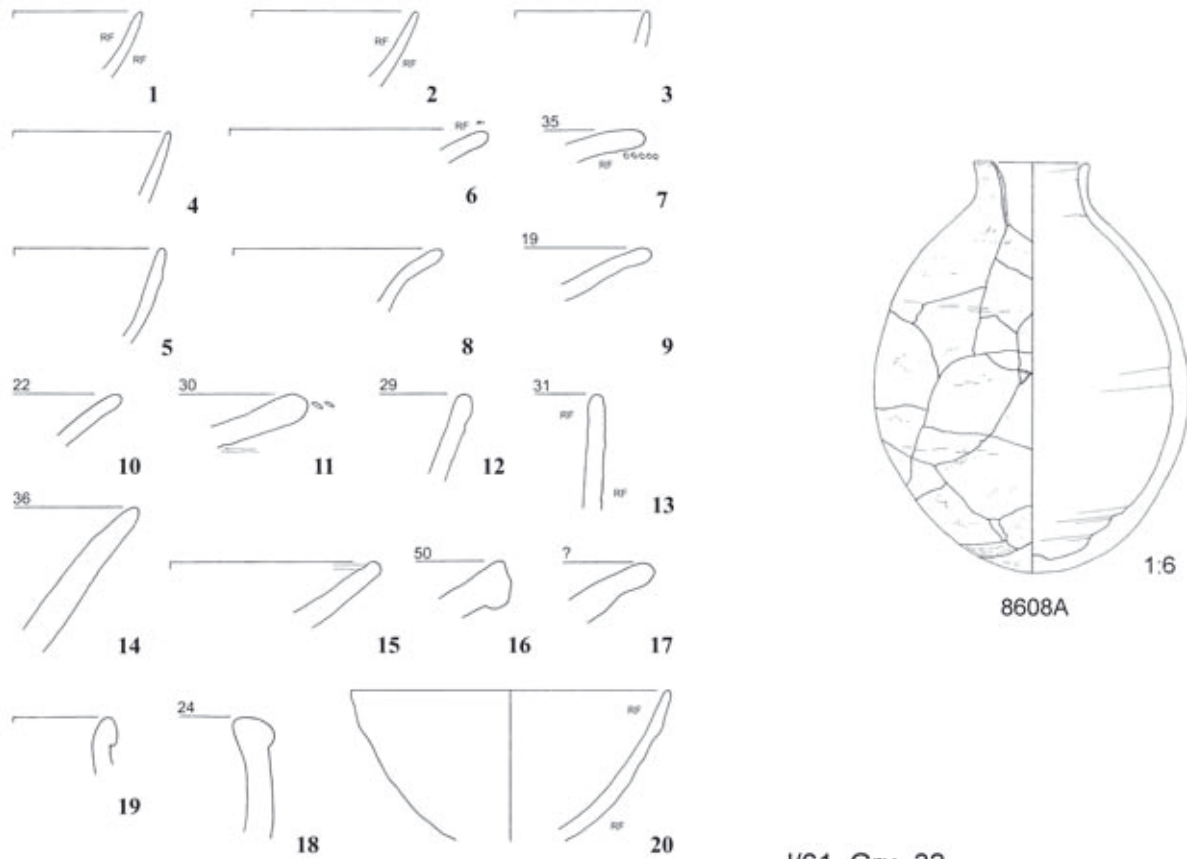

I/61, Gru. 32

K8324



I/61, Gru. 35-40; 43



K8323

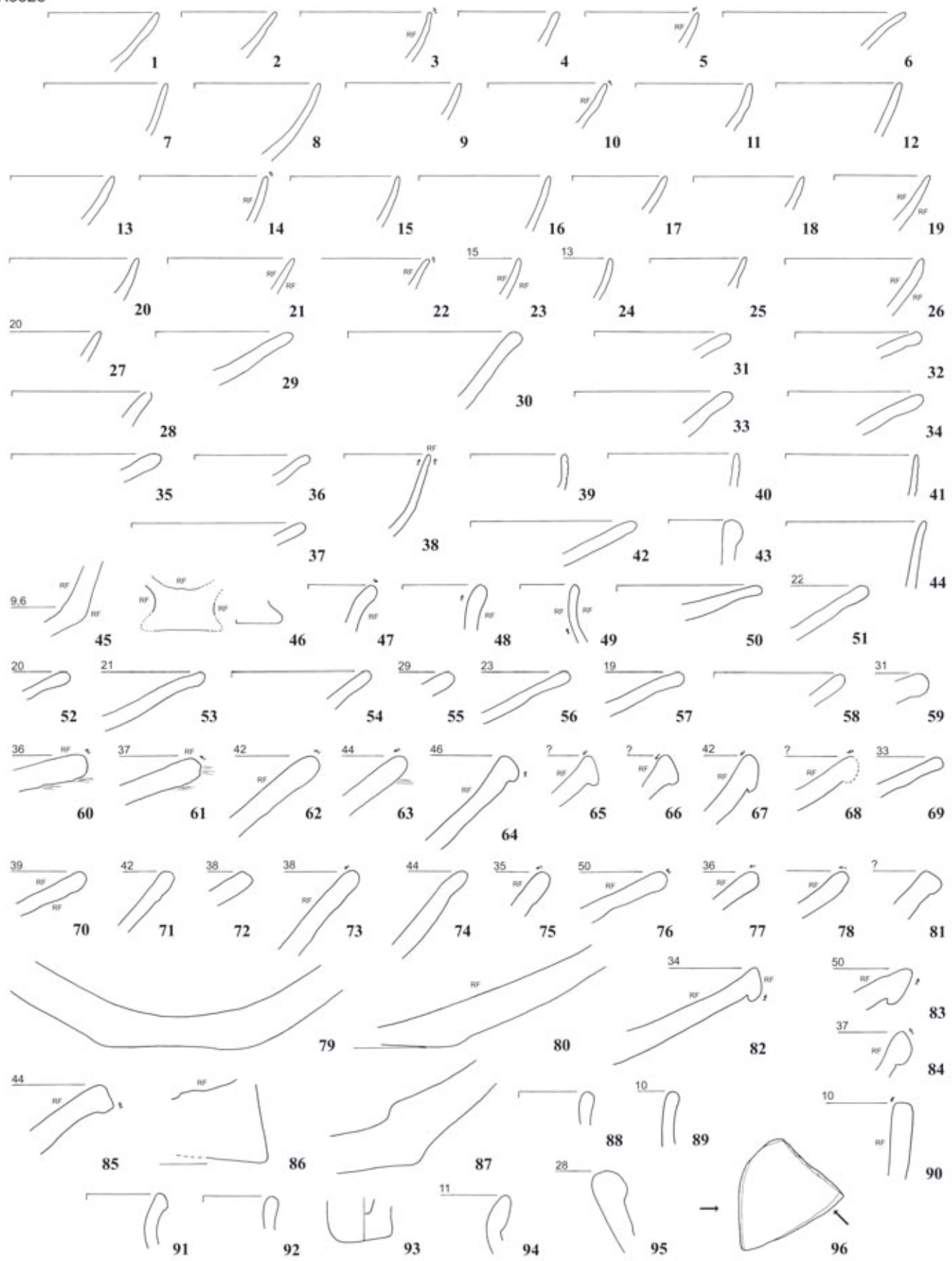

I/61, Gru. 31 (1)

Tafel 156



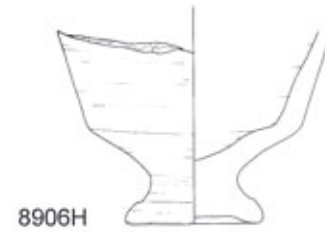
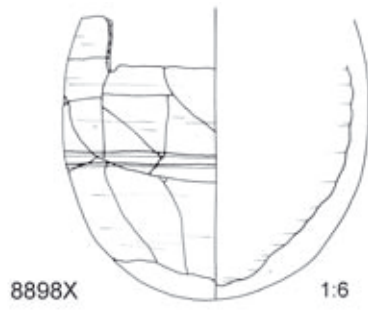

I/61, Gru. 31 (2)

K8248

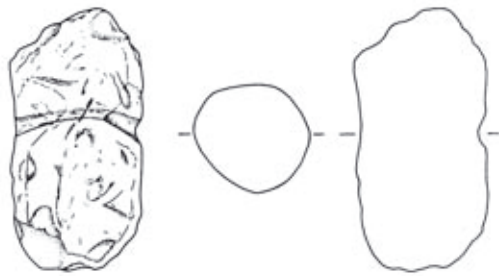
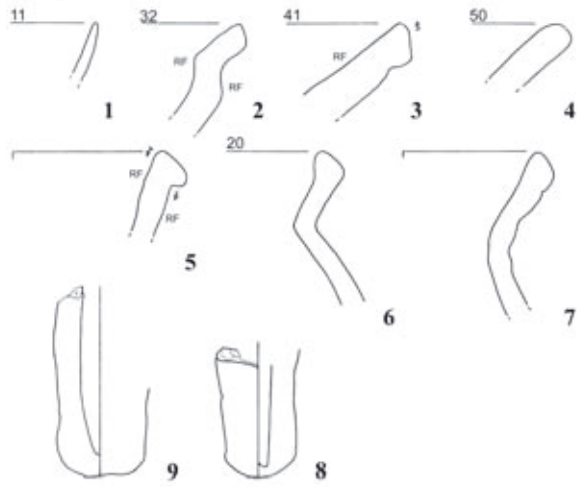

zu K8248

K8251

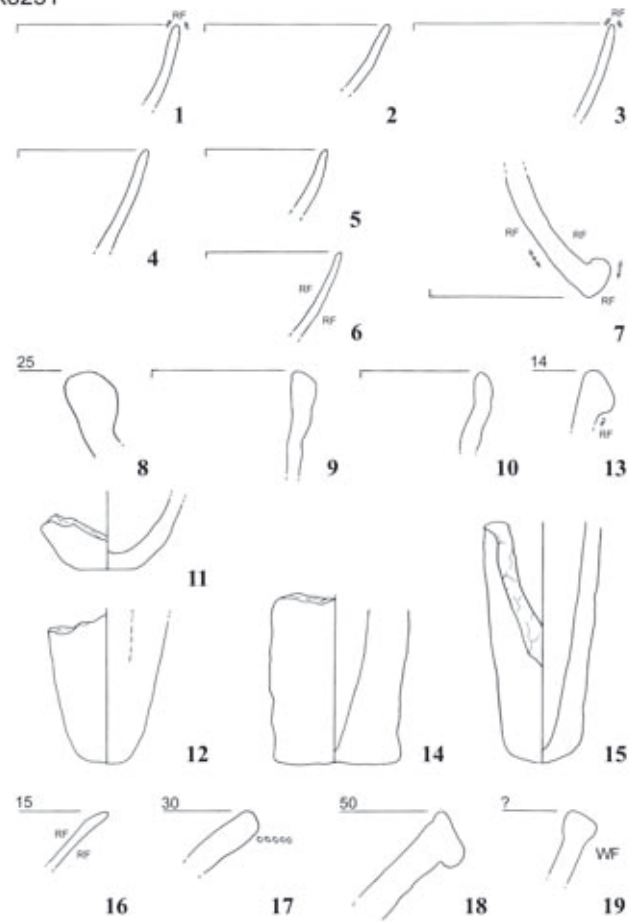

K8309



I/61, Gru. 1 (=k/61, Gru. 3; =I/62, große Störung)

K7303

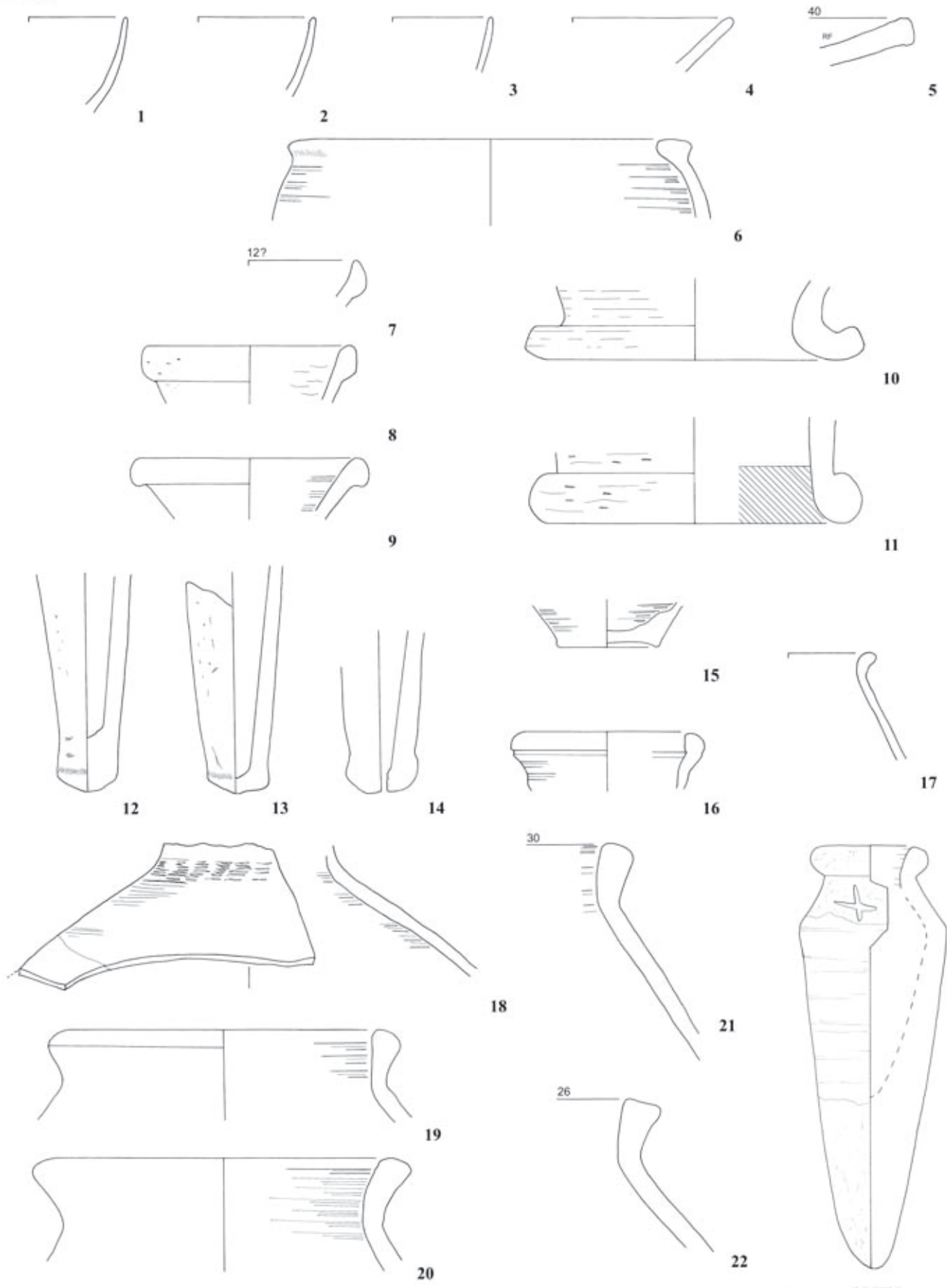

I/62, große Störung (=k/61, Gru. 3; = I/61, Gru. 1)

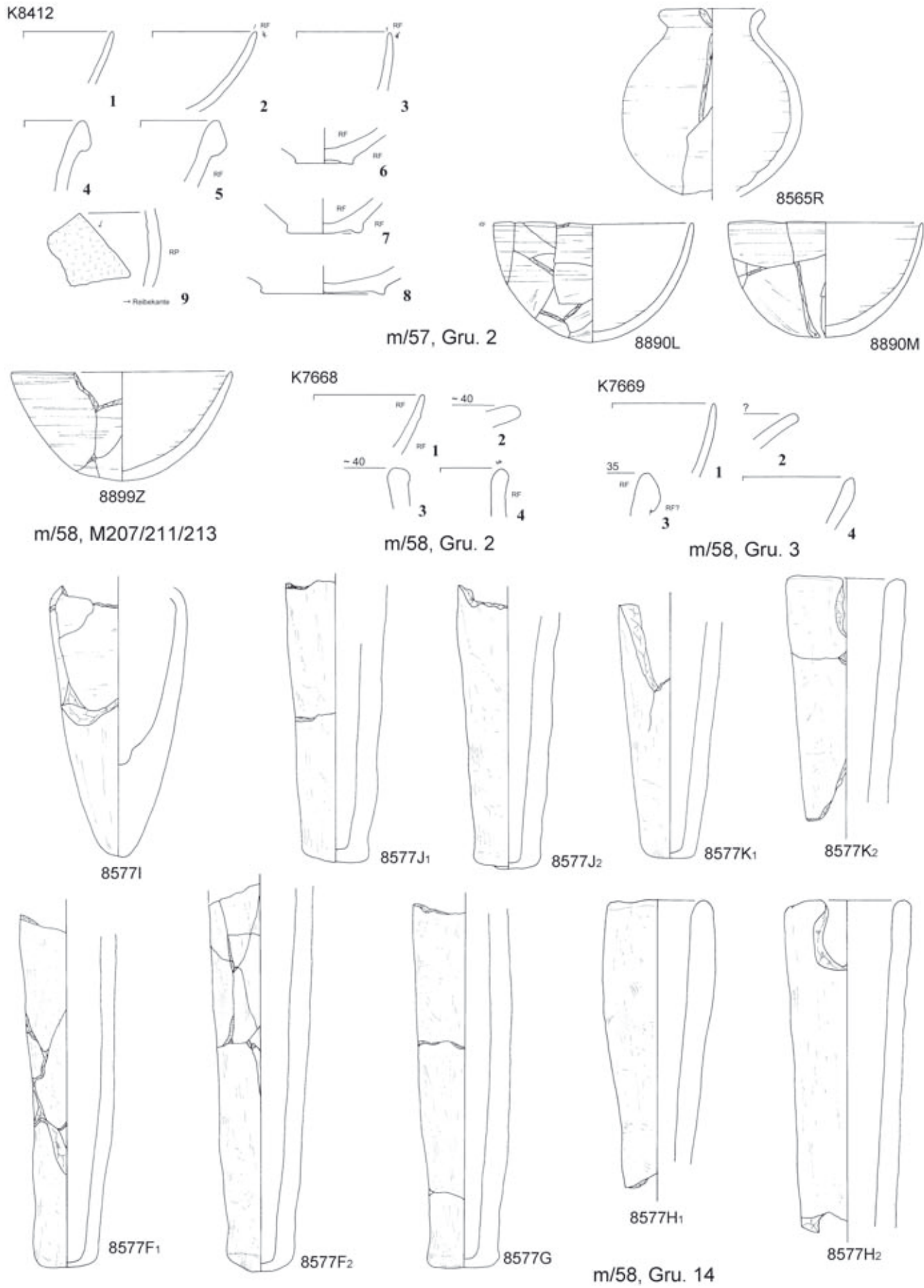

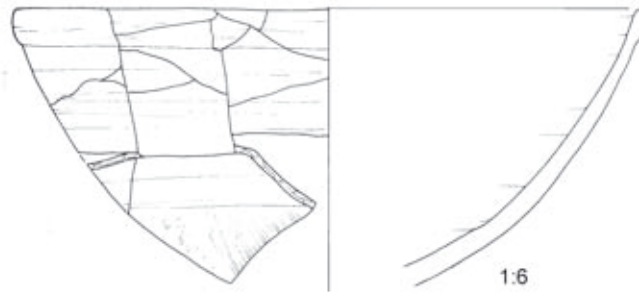

8900B

m/59, Schnitt am O-Profil

K8136

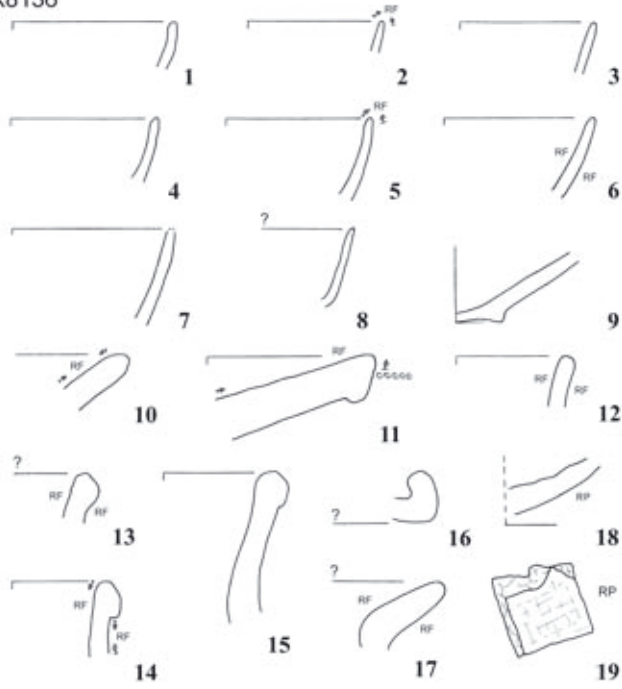

m/60, M686/687/688

K7984

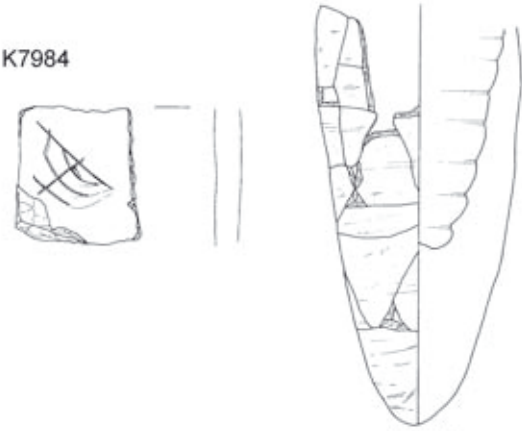

m/61, M248

8887T

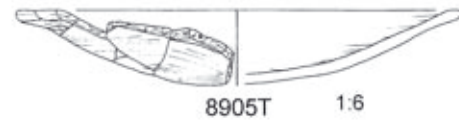

m/61, M249

K7971

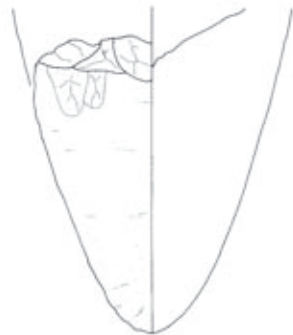

m/61, M265



8618P

m/61, M604/606



8558A

m/61, Grube im S-Profil

K7932

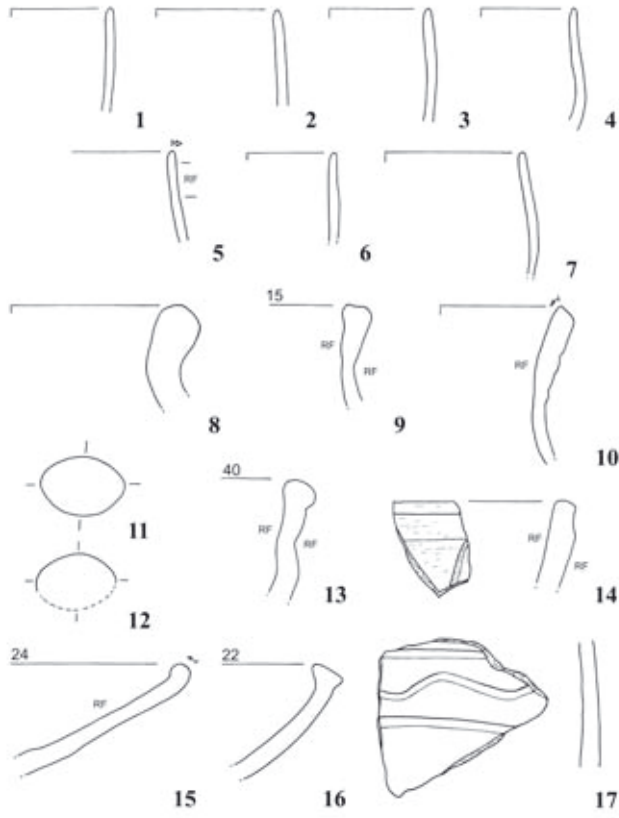

K8434

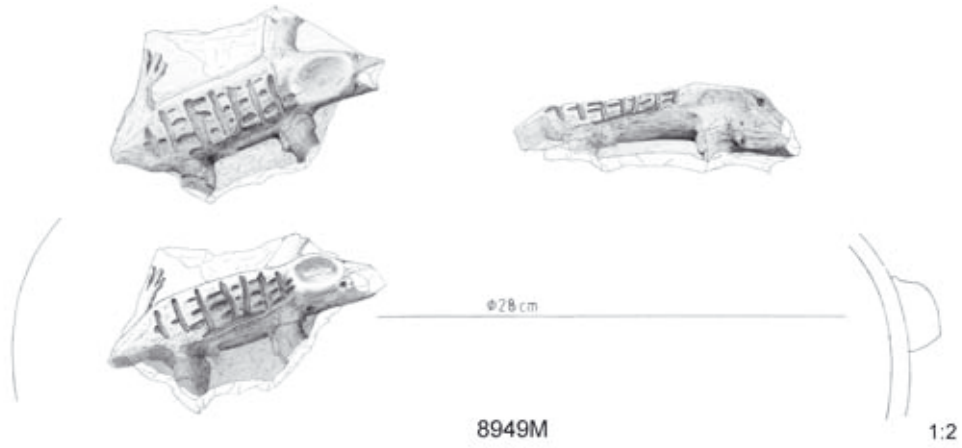
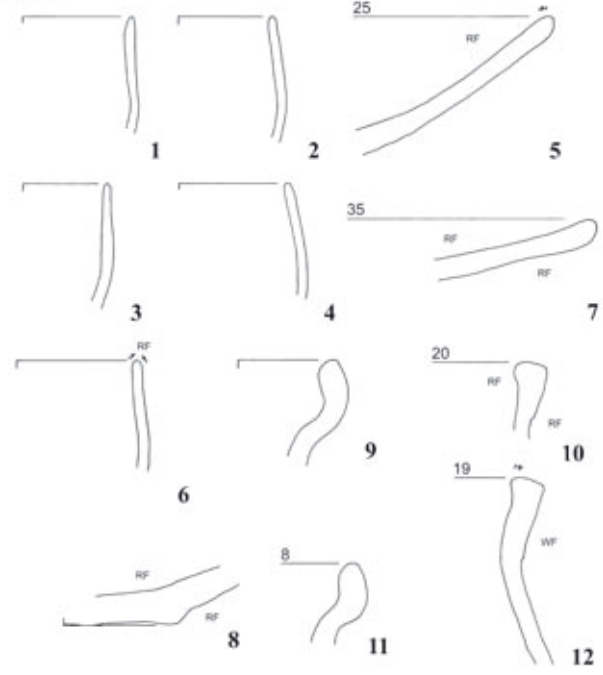

m/61, Gru. 1 (1)



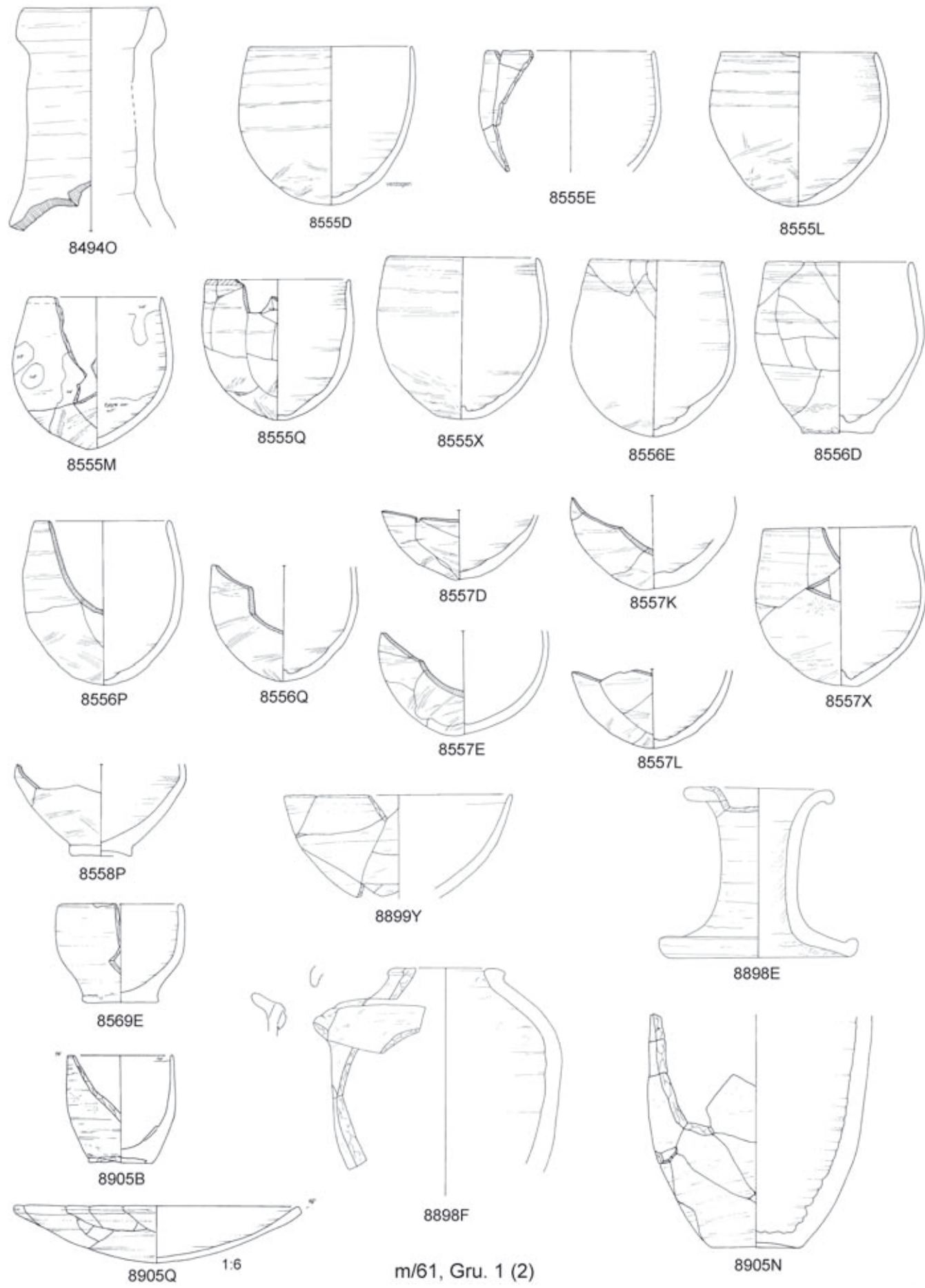



K7898

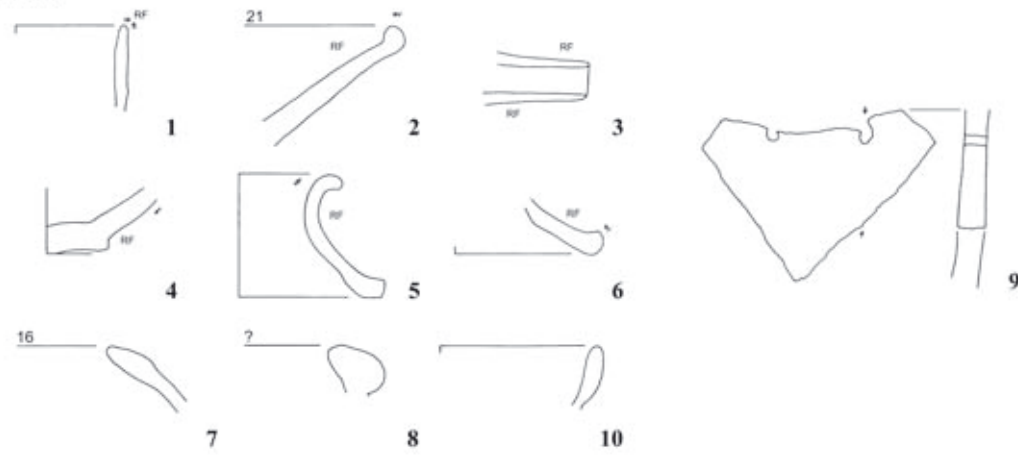

K7910

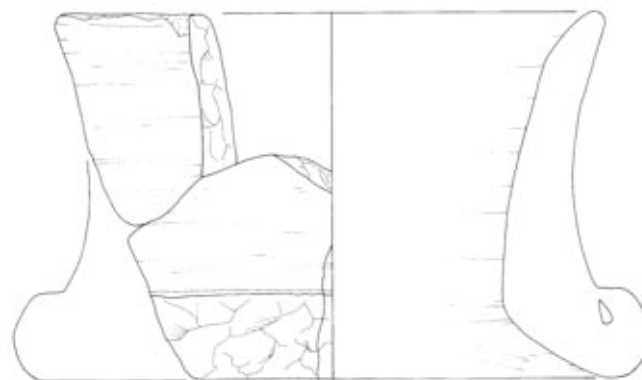
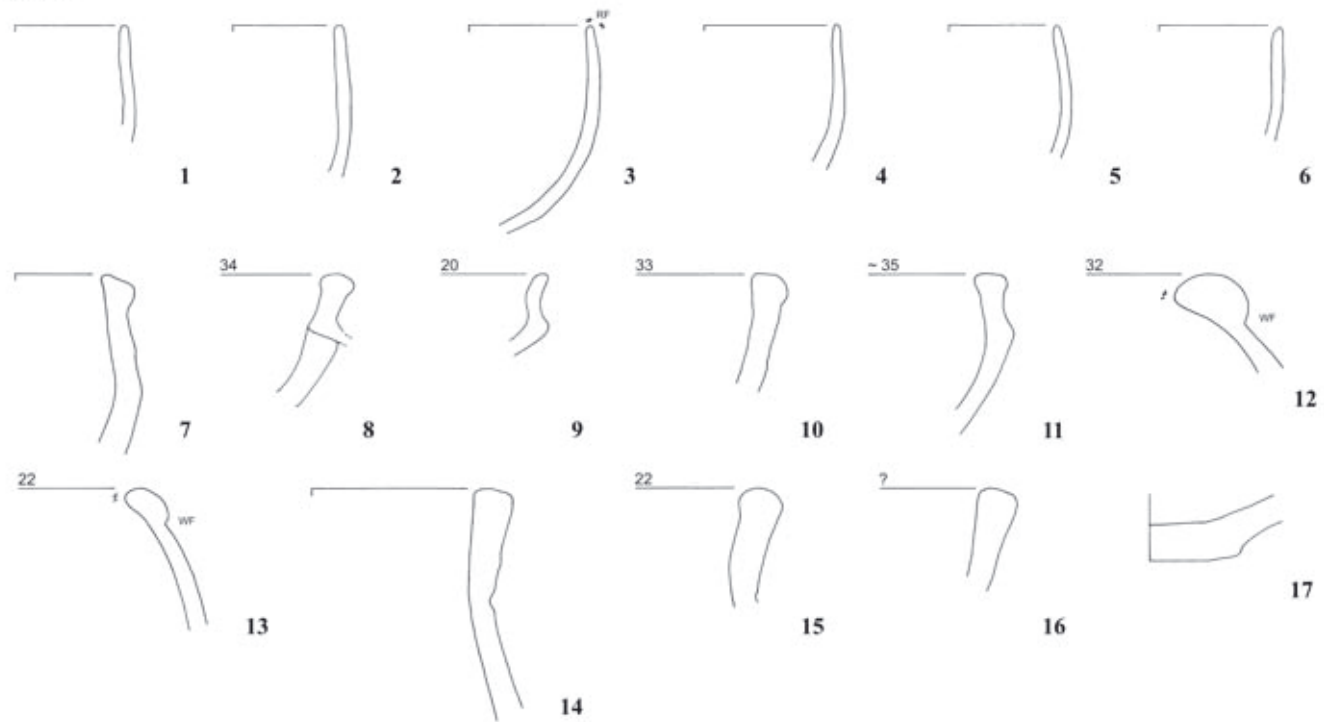

8913S

m/61, Gru. 2

K7896

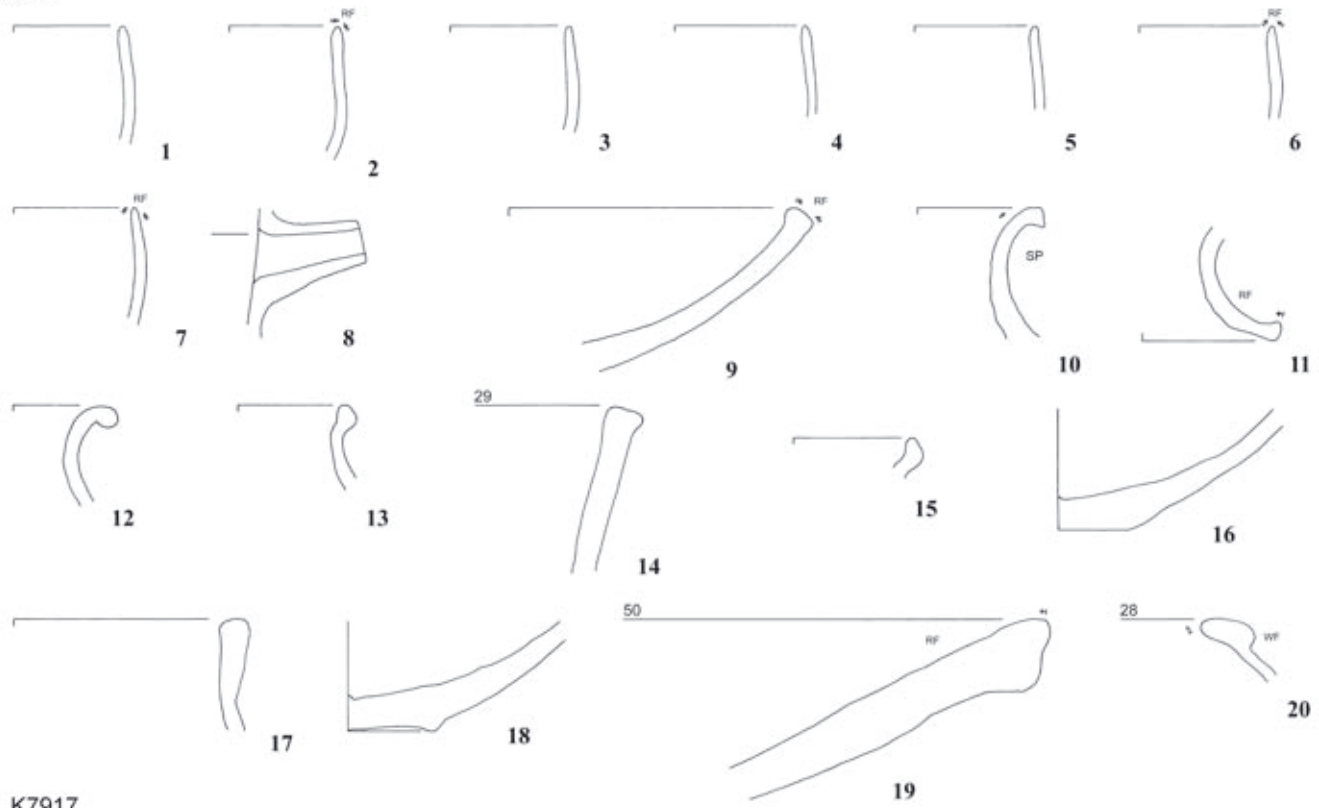

K7917

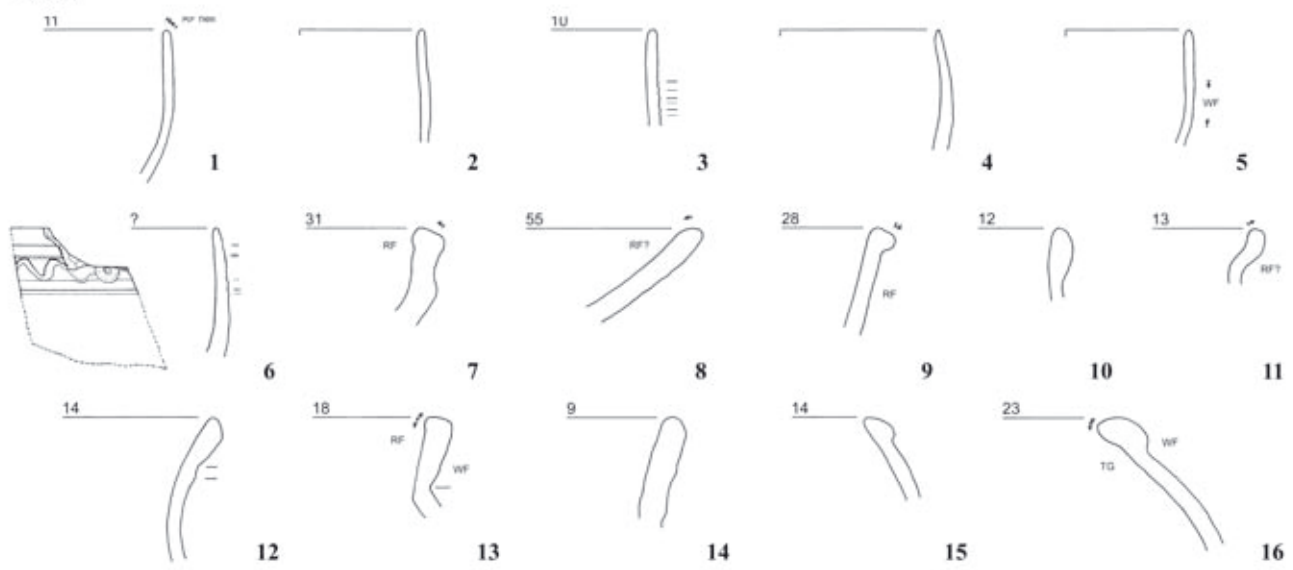

K7930

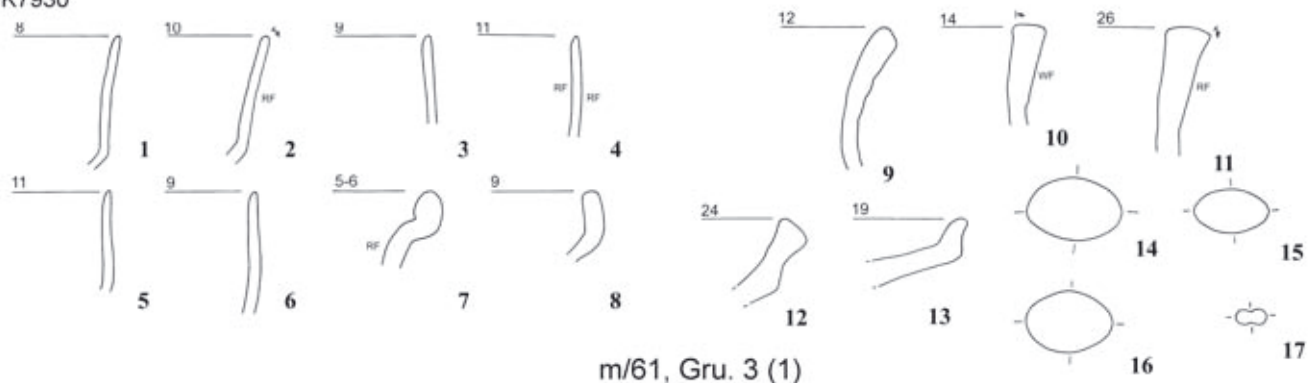

m/61, Gru. 3 (1)

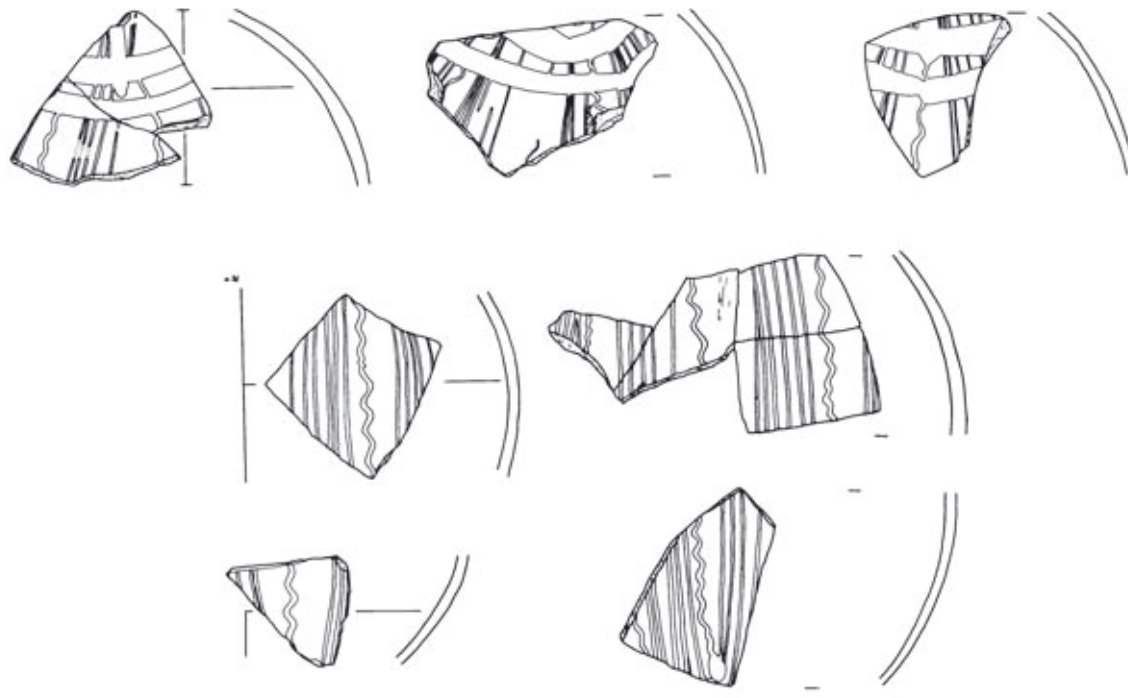

8617F

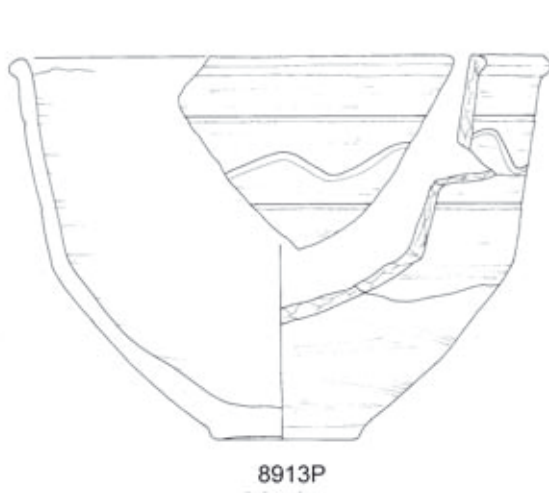

8913P



8555O

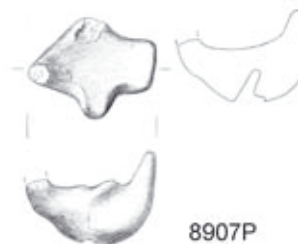

8907P

m/61, Gru. 3 (2)



8555F

m/61, Gru. 4

K7931

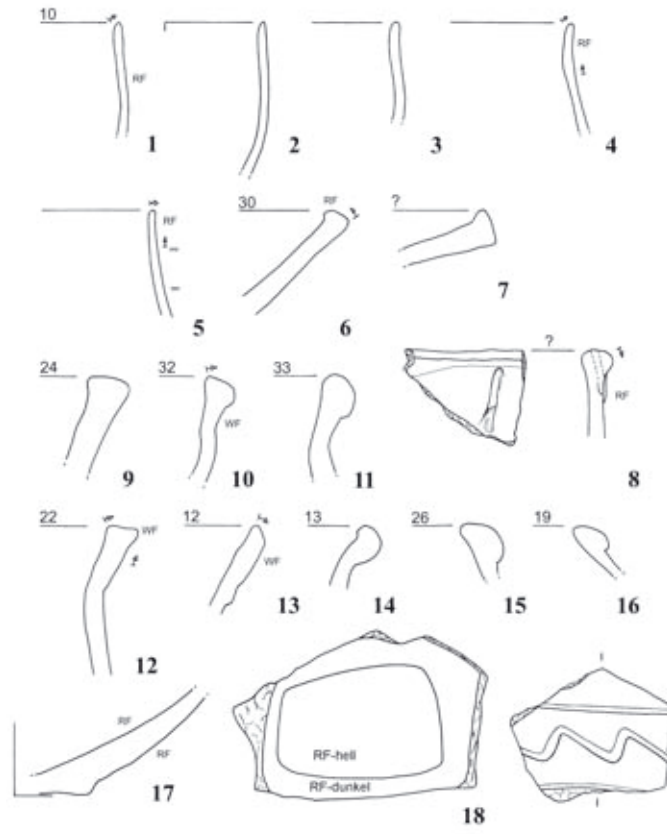

K7942

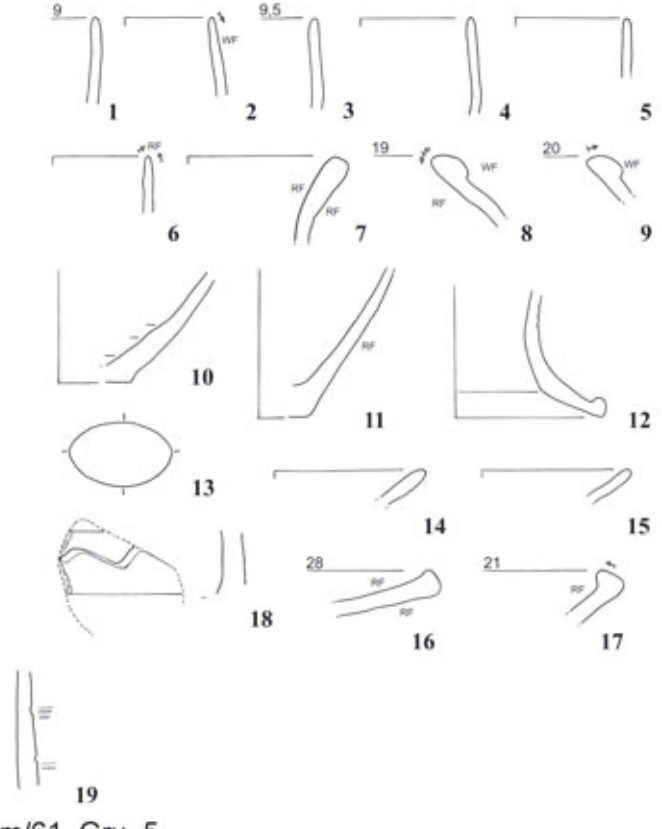

m/61, Gru. 5



8555R

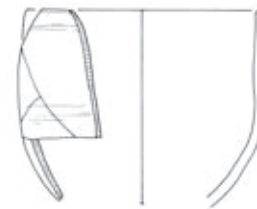

8555S

m/61, Gru. 6



8556O

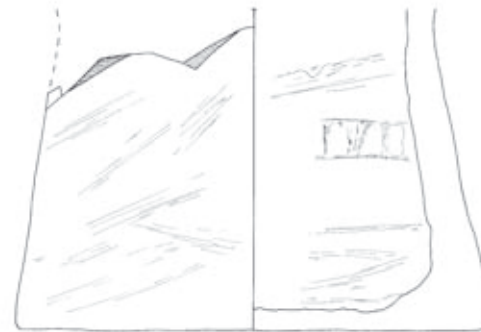

8559K



8905S

m/61, Gru. 7

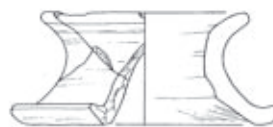

8913Q



8913R

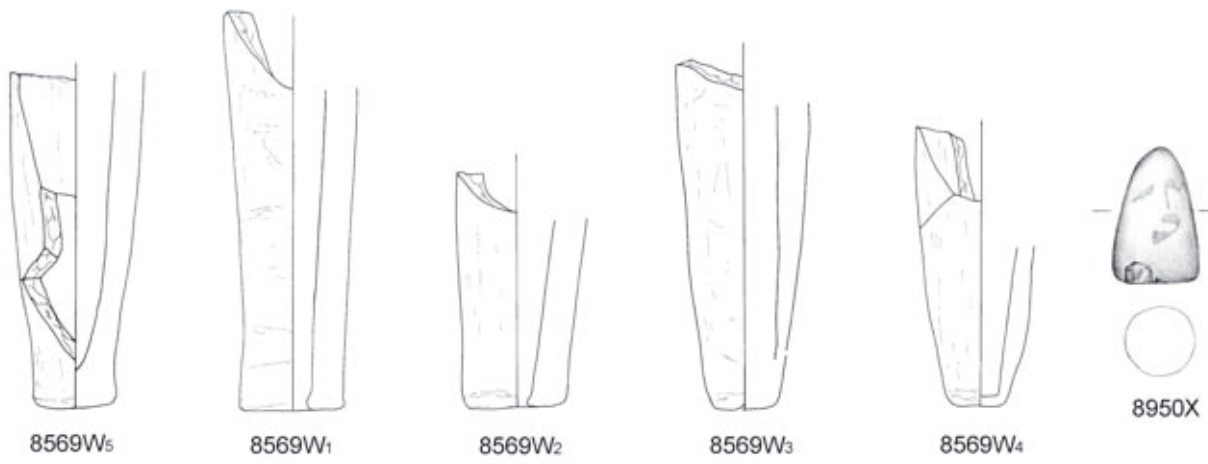

m/62, M241

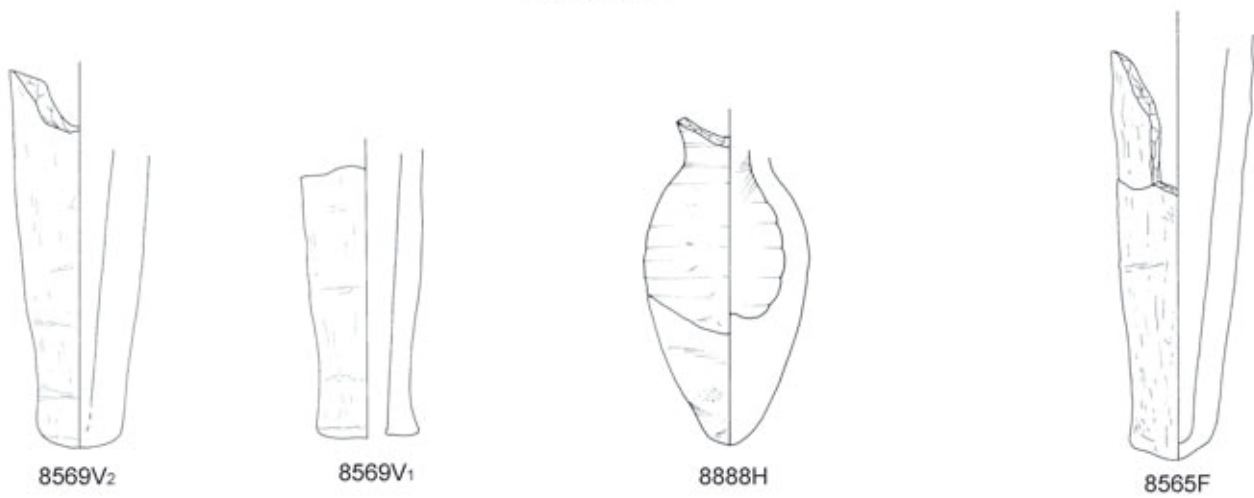

m/62, M242

m/62, M263

m/62, M630

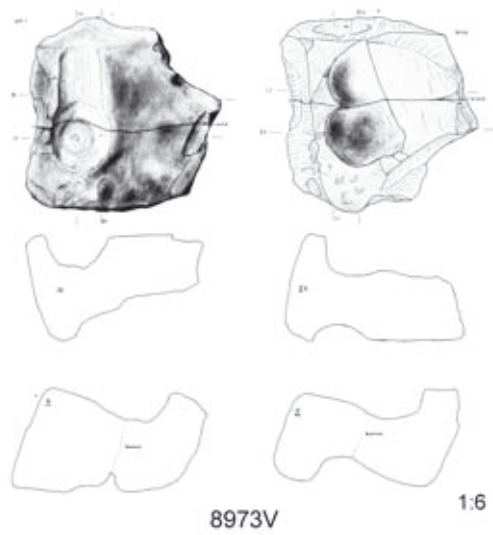

m/62, M302

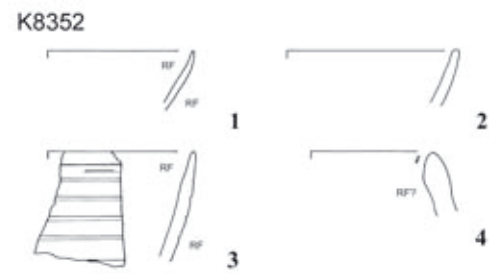

m/62, Mauern str. d (?)

K8410



8569U

m/62, ganzes Plq. str. e/4 - f



K8326

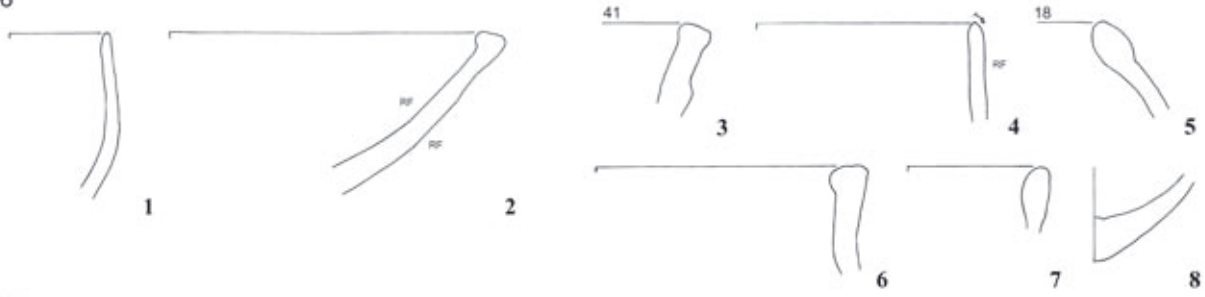

K8327

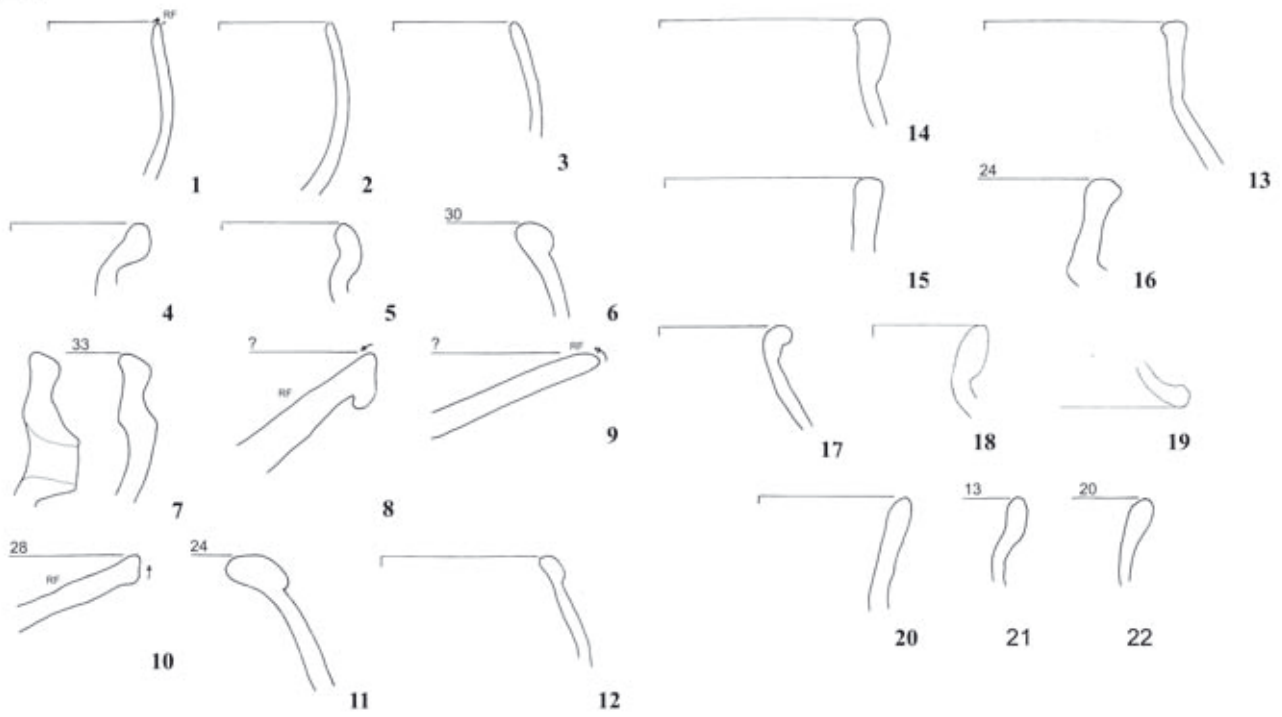

8555P

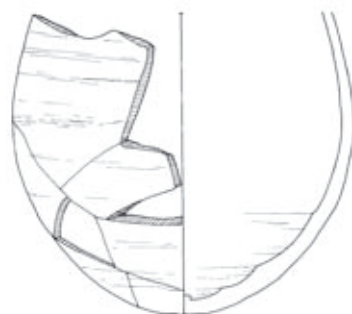

8555T



8897W



8569S



8928A



9145B



9145C

m/62, Gru. 1

K8328

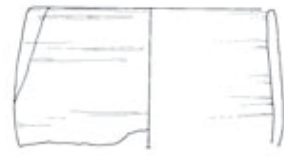
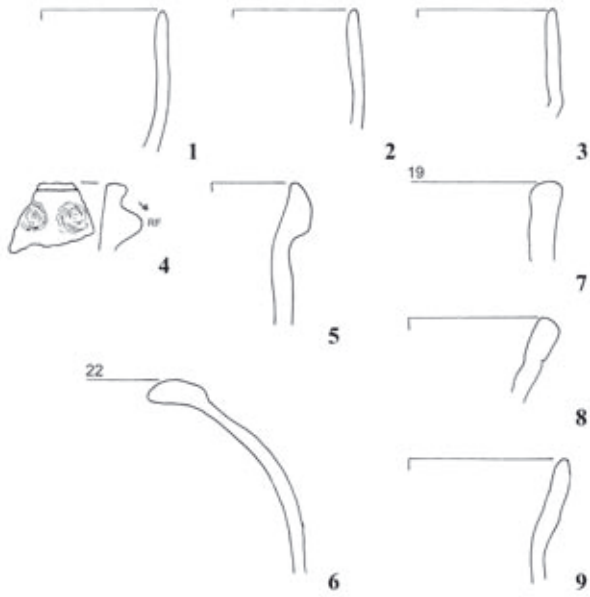

8555W

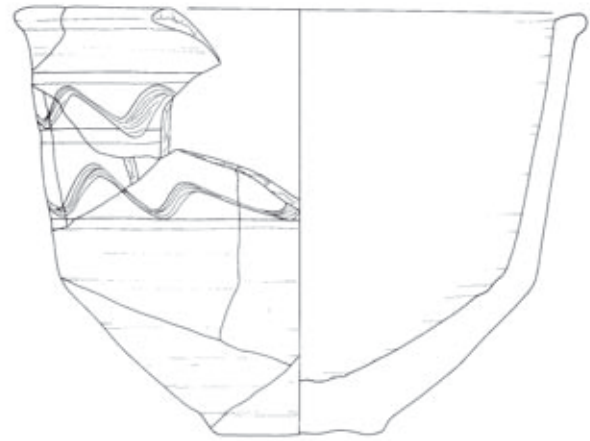

8565V

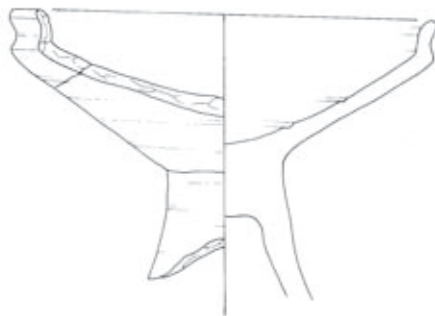

8565T

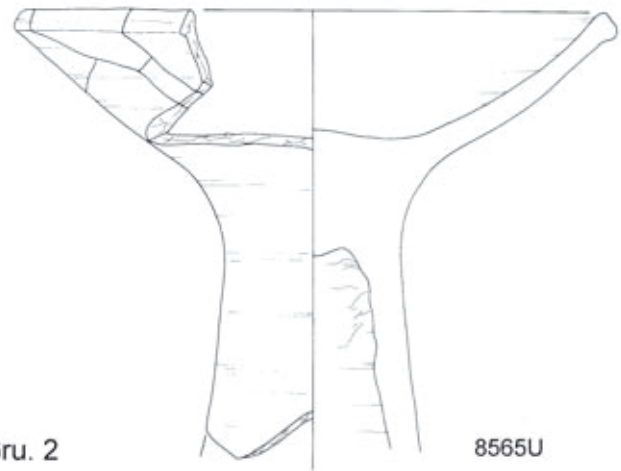

8565U

m/62, Gru. 2

K8331

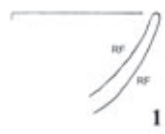

m/62, Gru. 3

K8330

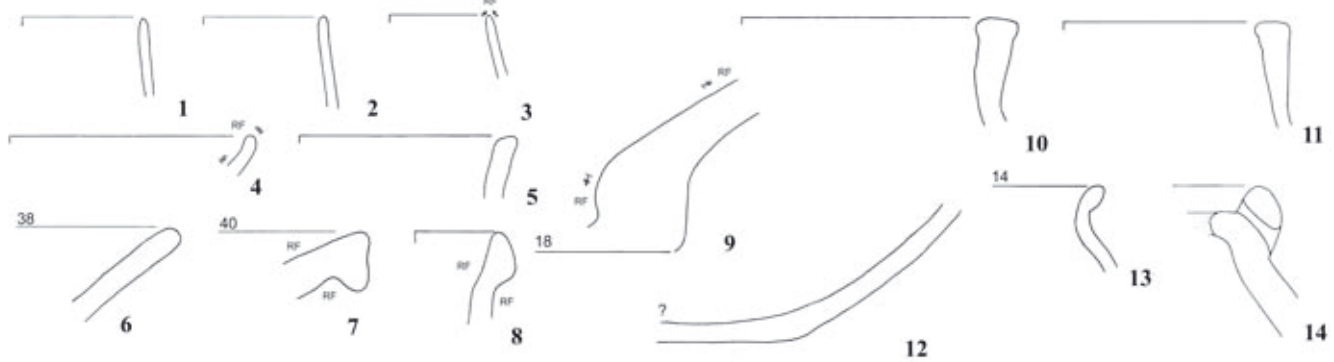

m/62, Gru. 4

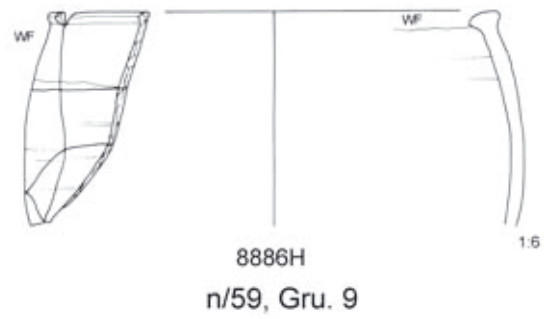
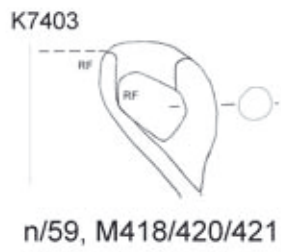
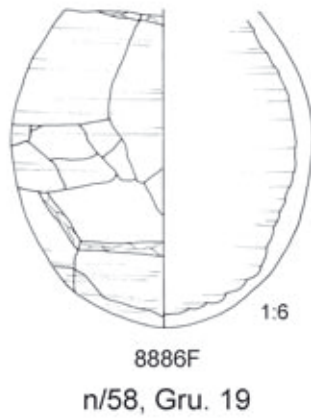
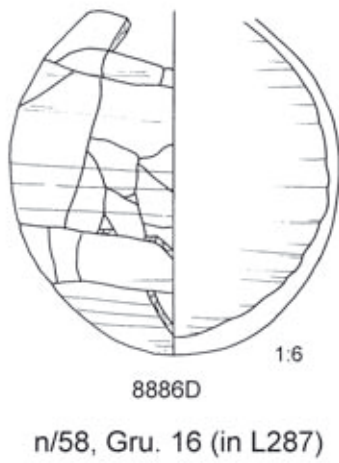
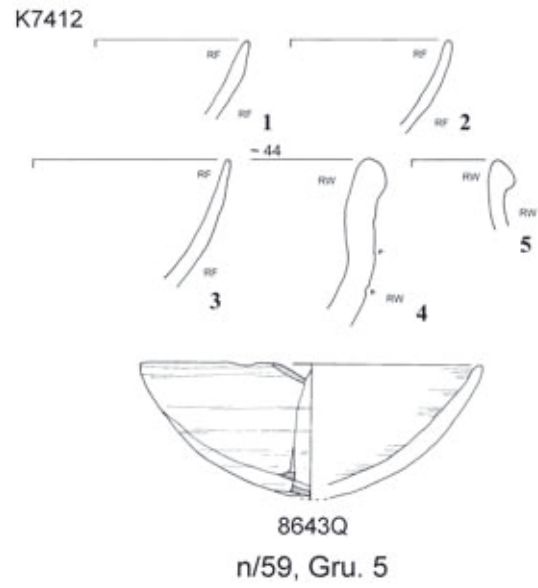
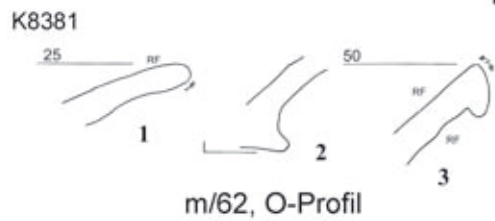
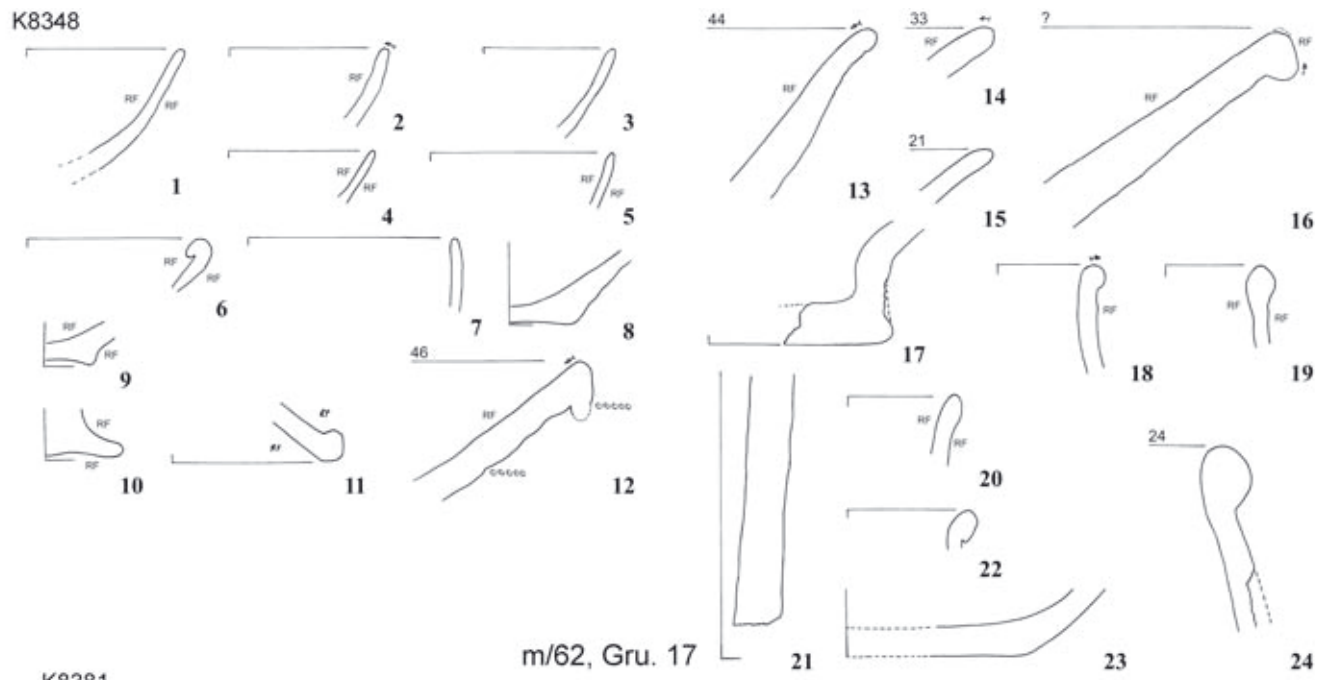

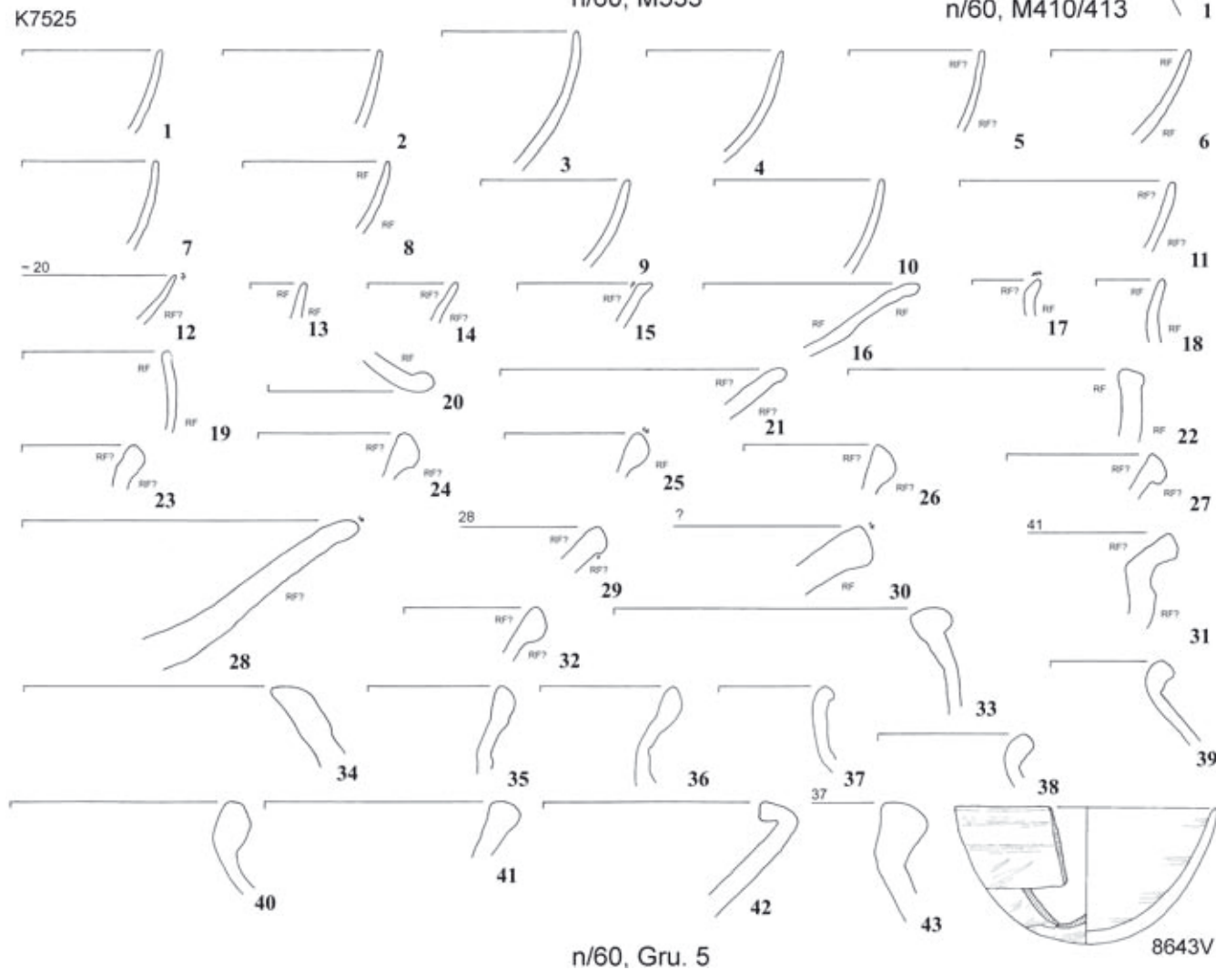
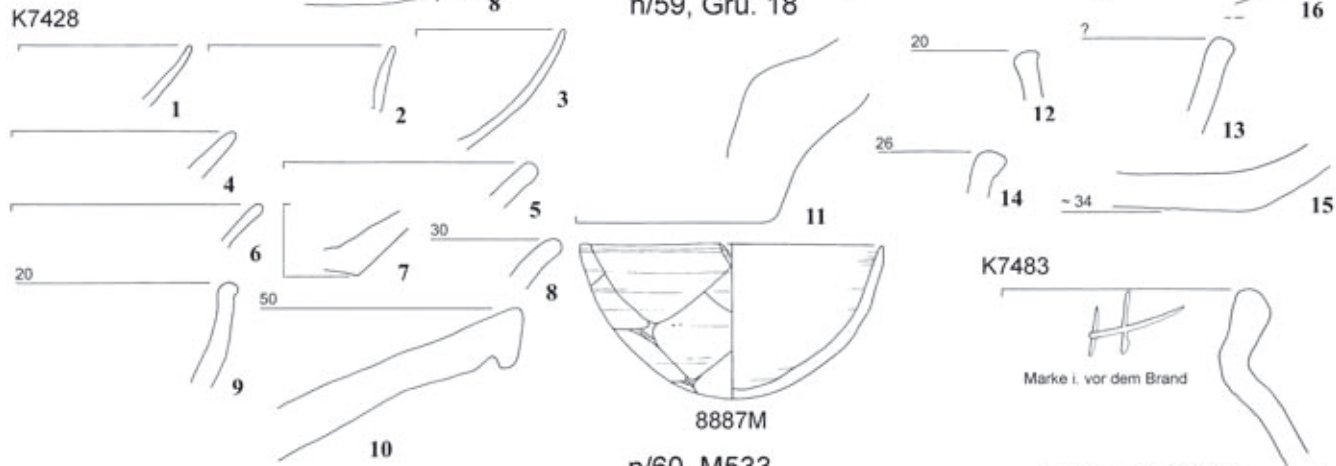
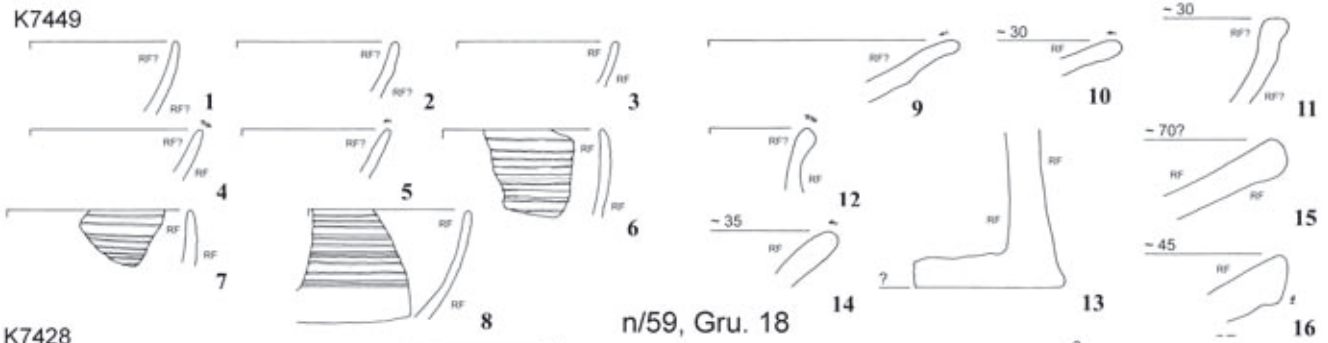

n/60, Gru. 5

K7476

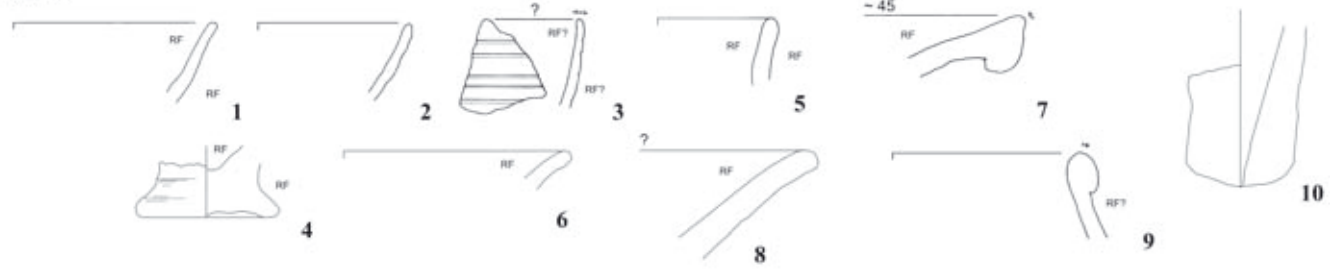

K7478

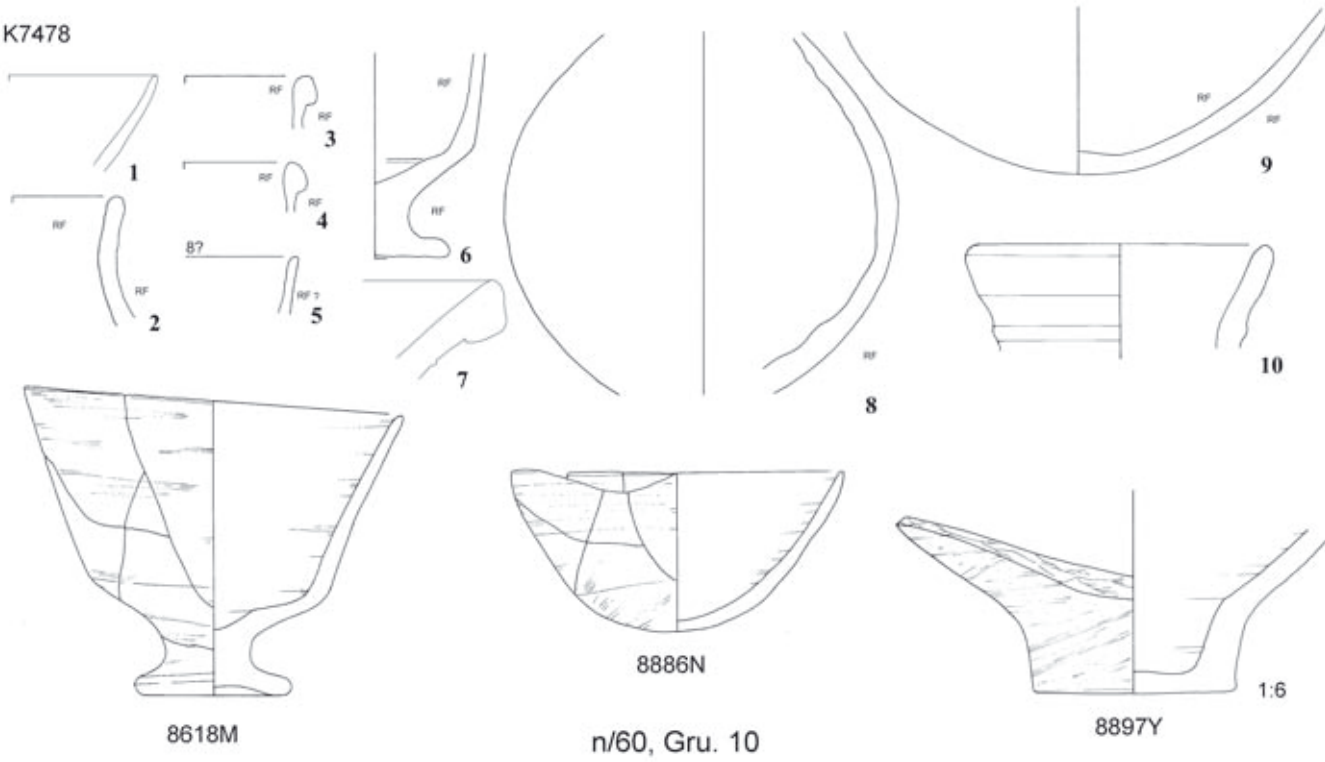

K7463

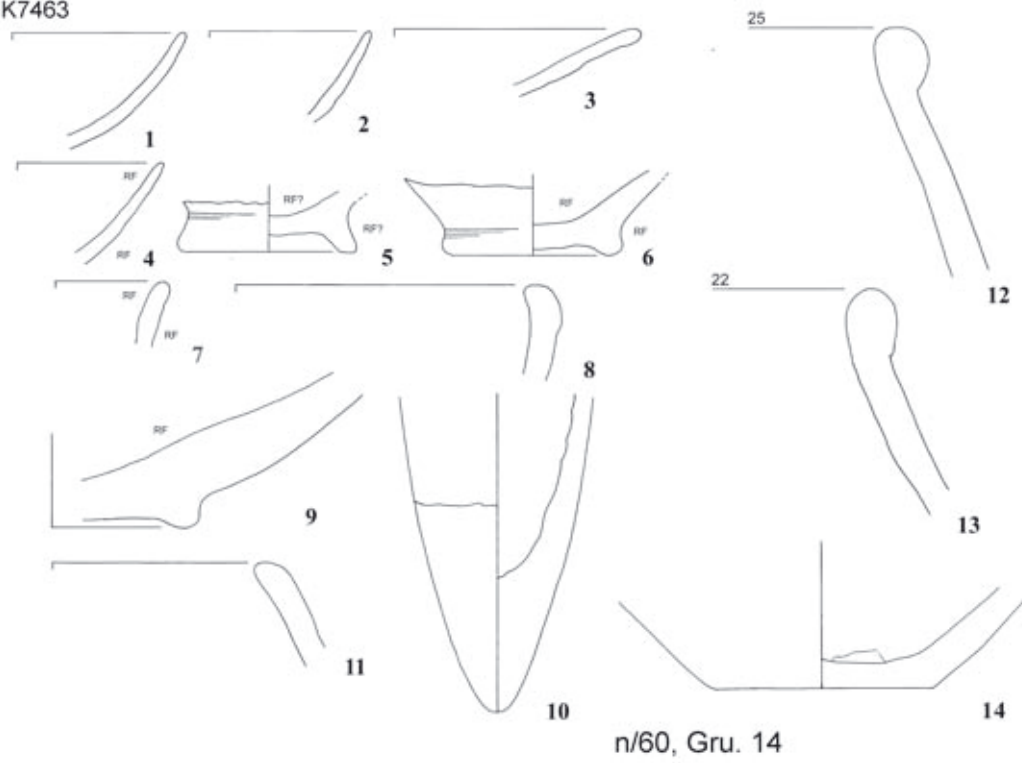

K7466









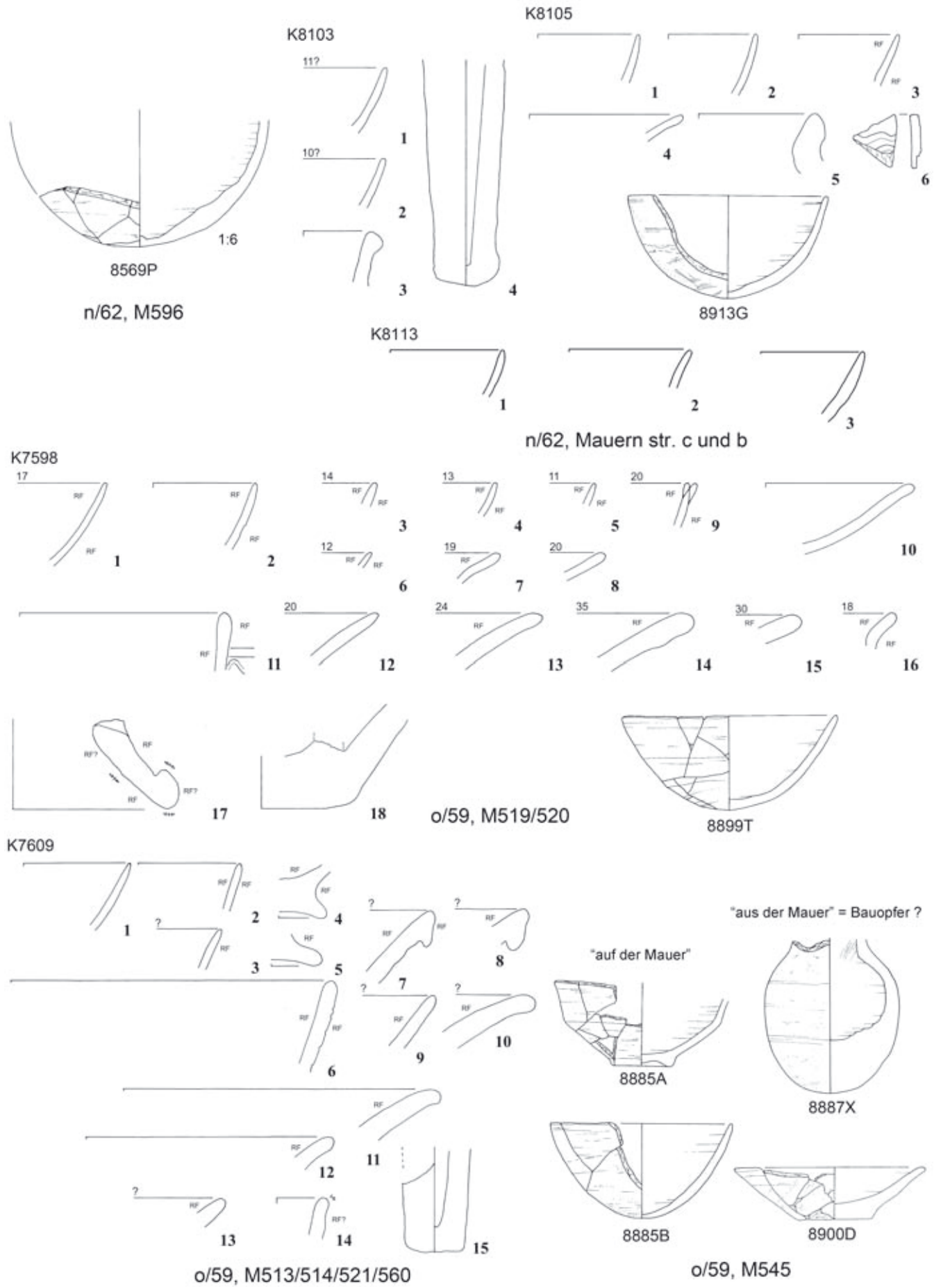

K7564

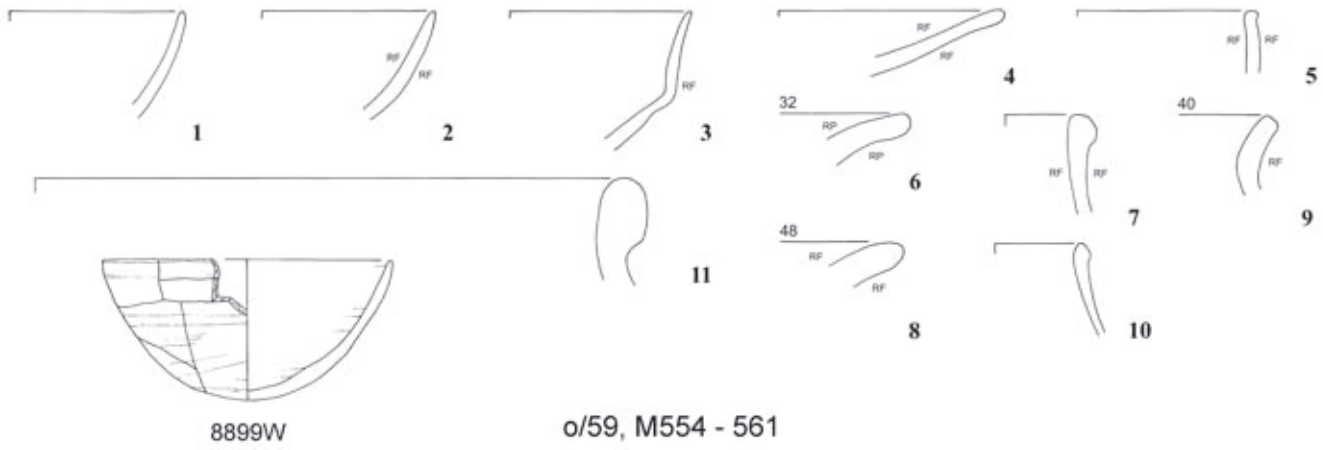

K7561

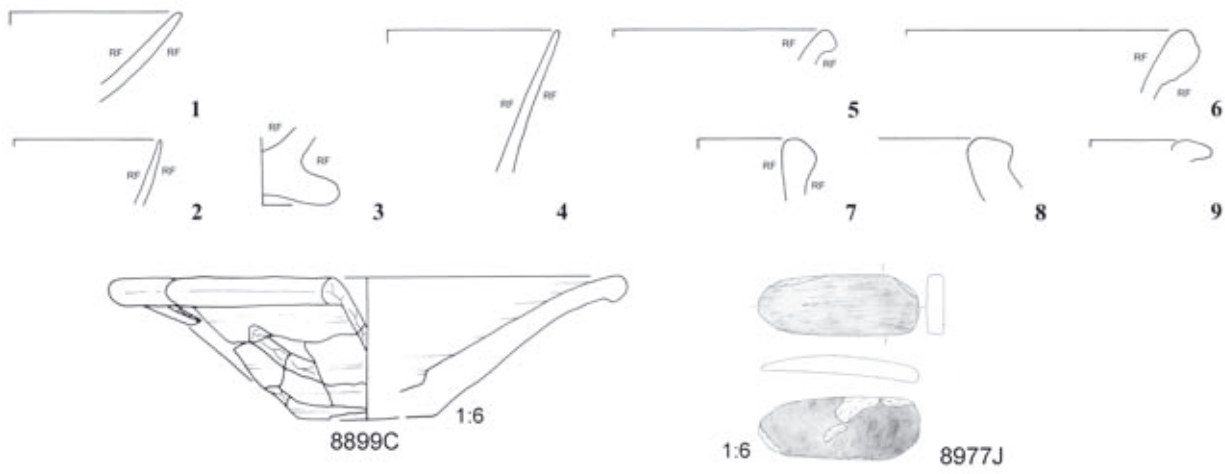

o/59, zwischen M561 und M547

K7557

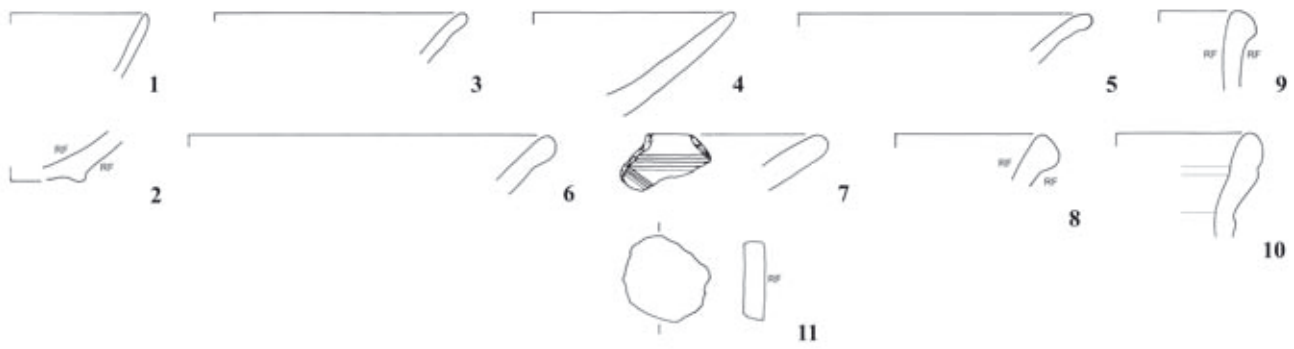

K7587



o/59, M567

K7586

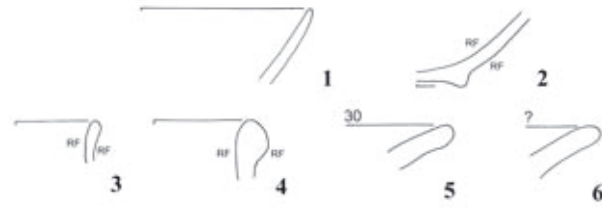

o/59, Mauern str. c

K7597

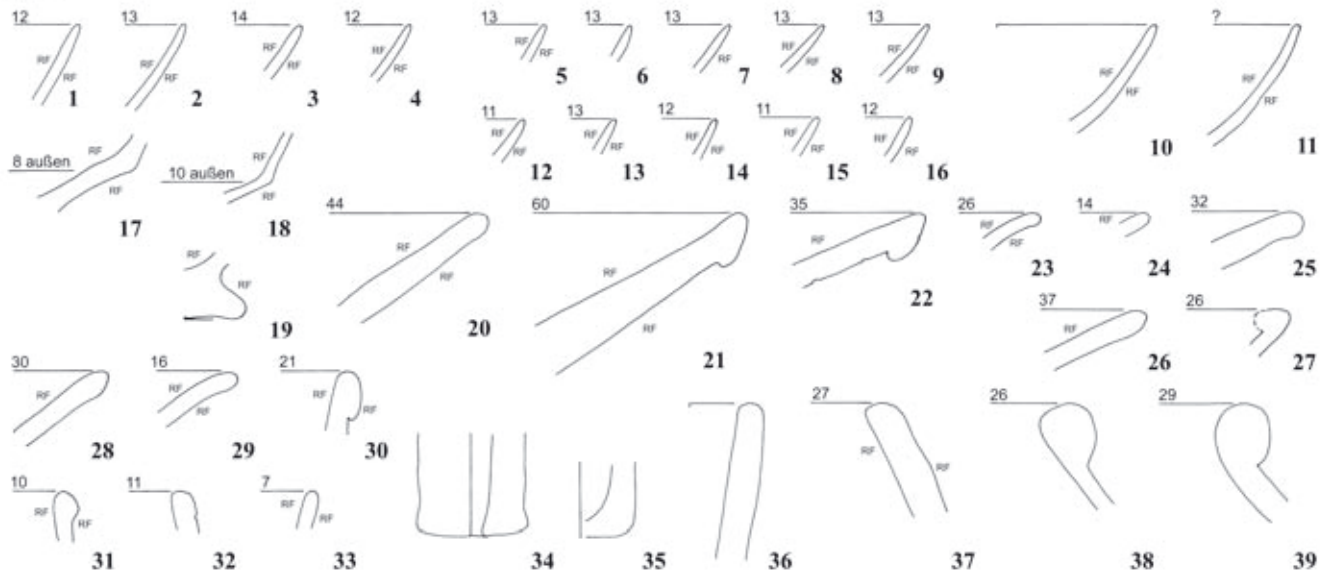

o/59, Mauern str. e/1

K7609

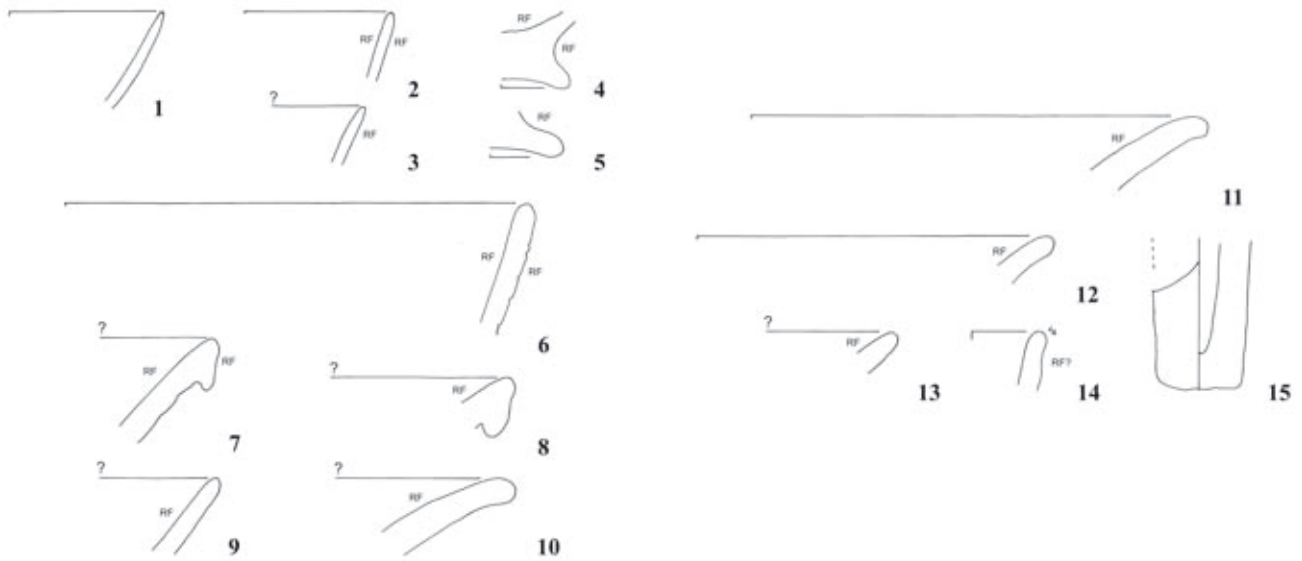

o/59, Mauern str. e/2

K7556

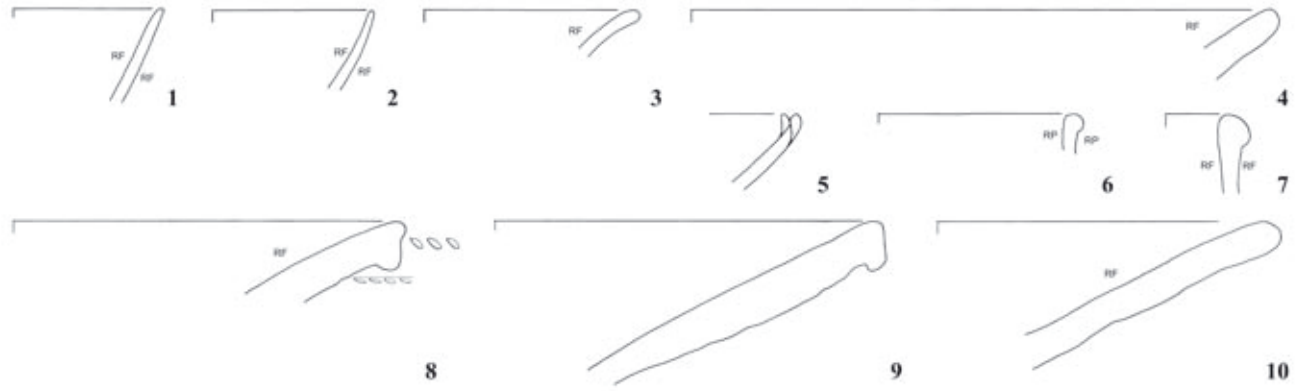

o/59, Gru. 1

K7549

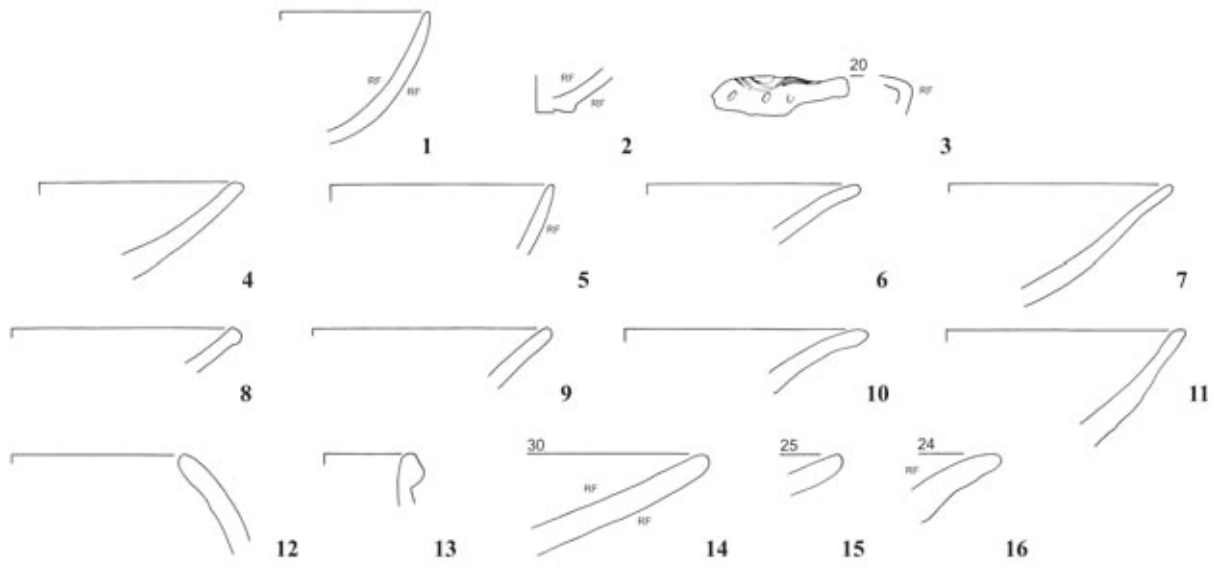

8569

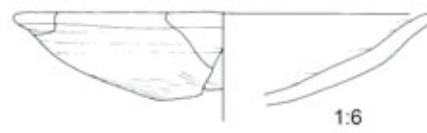

8569R

1:6



8900F

o/59, Gru. 2

Tafel 179

K7560

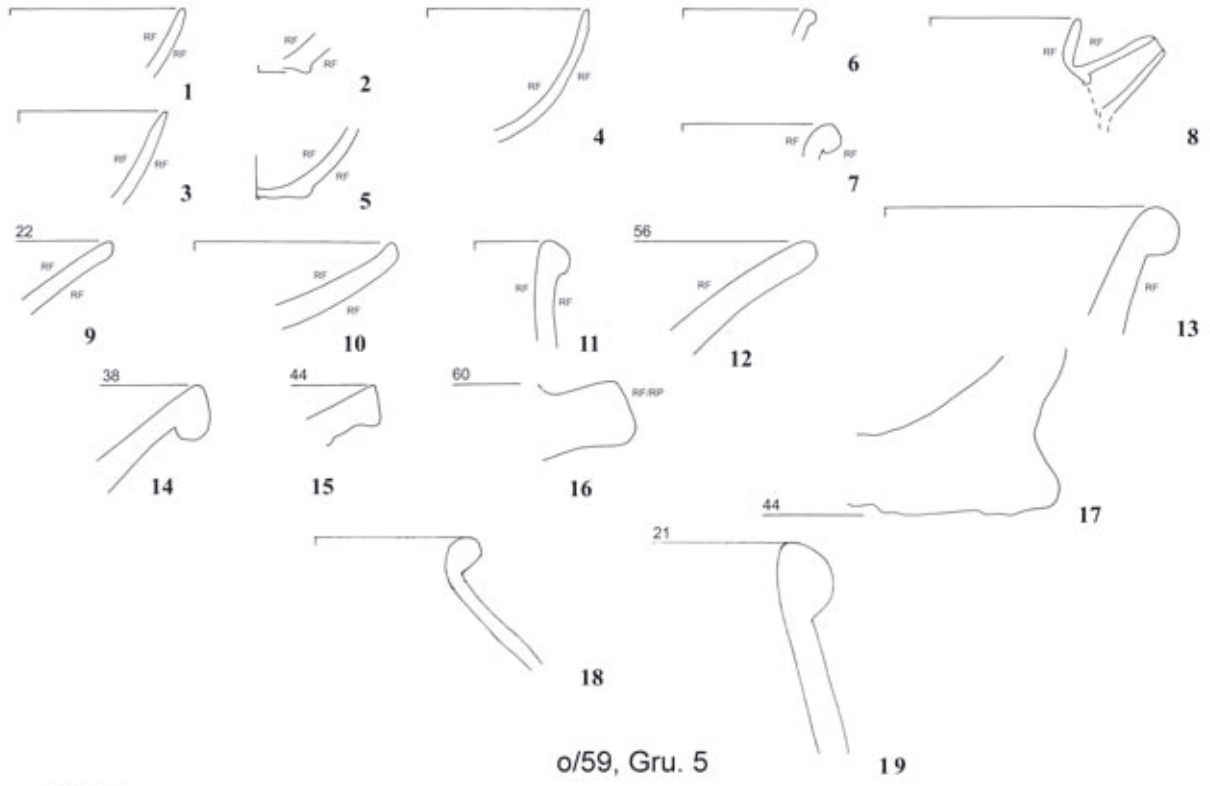

o/59, Gru. 5

K7562

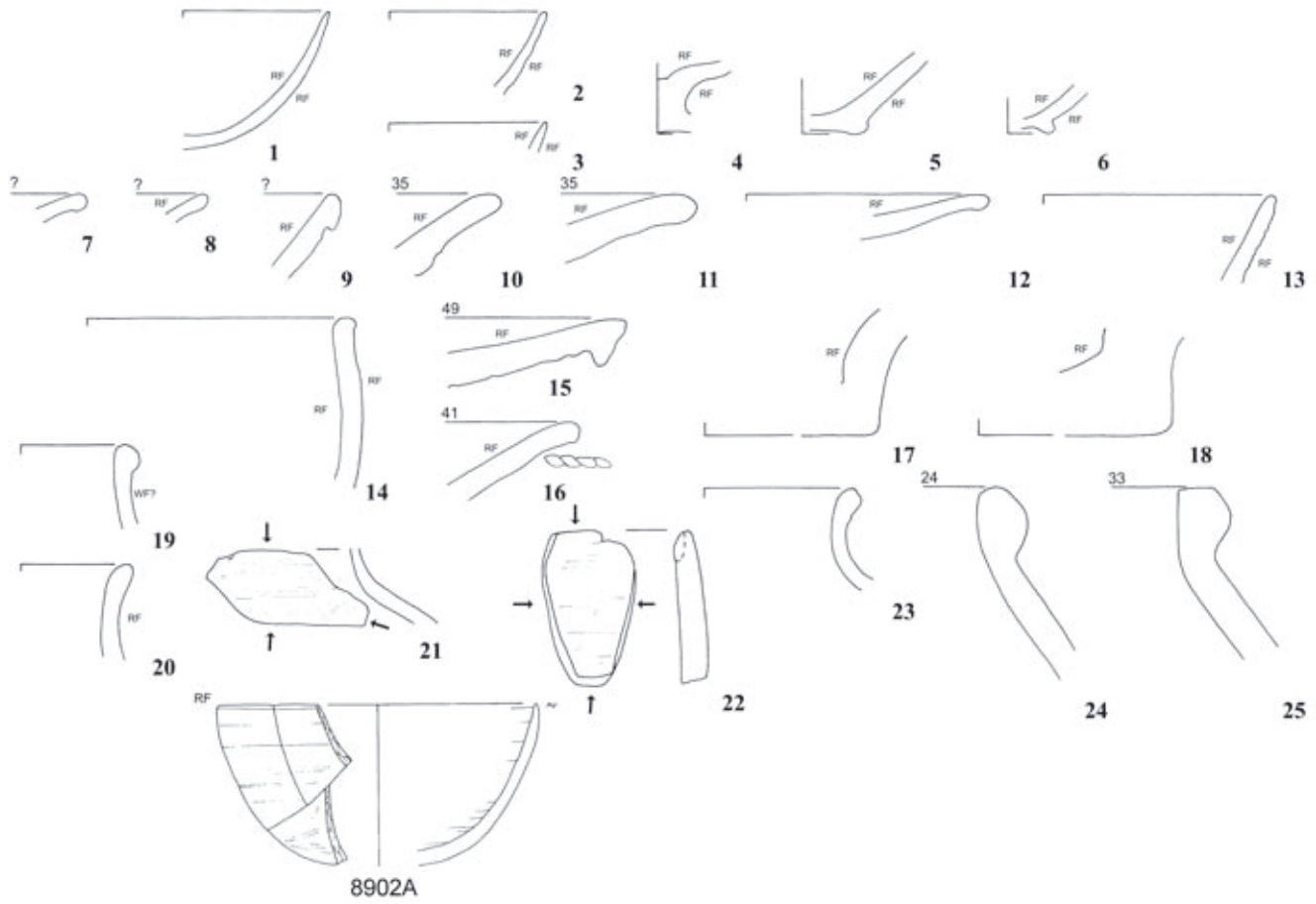

8902A

o/59, Gru. 8



K7573

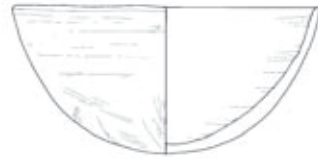
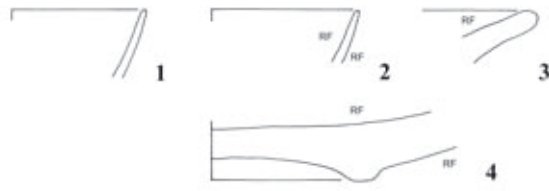

8600

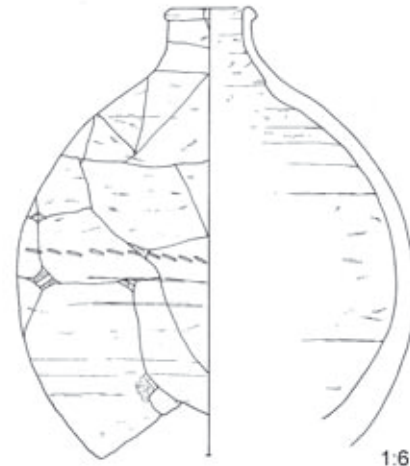

86180

o/59, Gru. 9

K7574



o/59, Gru. 10



8885D



8890U

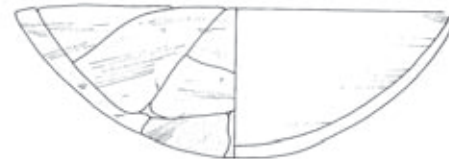

8900E

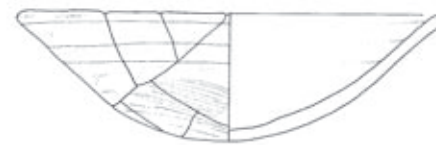

8900G

o/59, Gru. 11

K7576

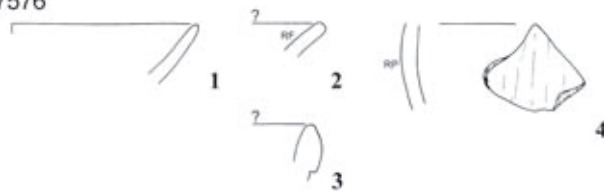

8643D

o/59, Gru. 12

K7583



o/59, Gru. 18



86430

K7602

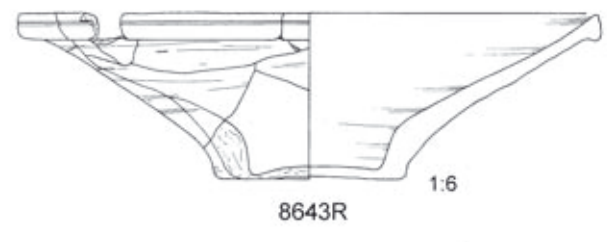
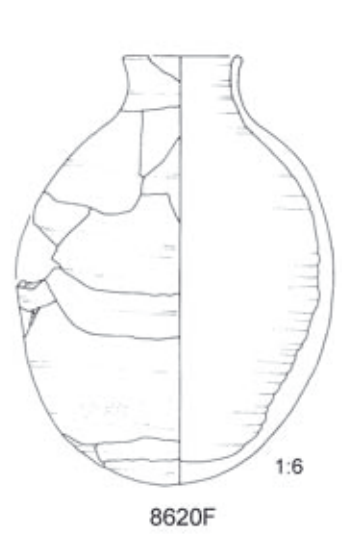
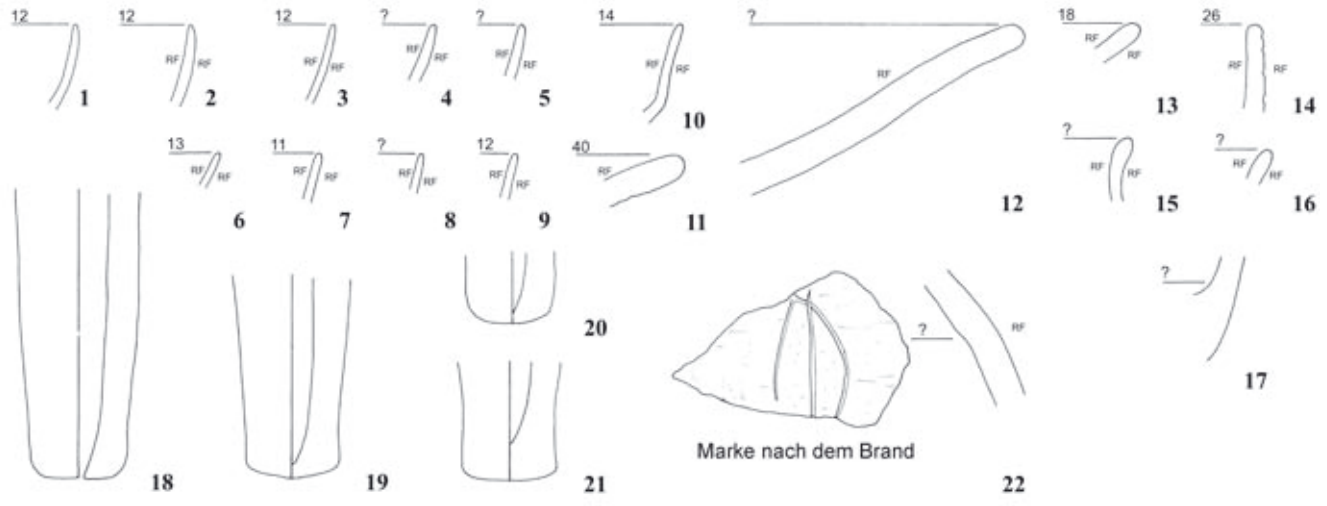

o/59, Gru. 22

8899R

K7613

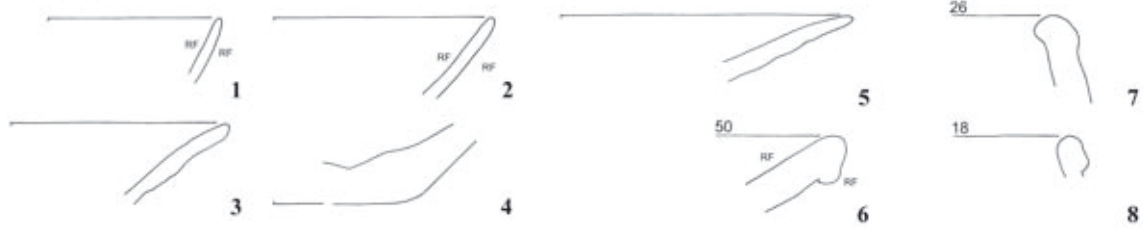

o/59, Gru. 25

Nachtrag



K8204

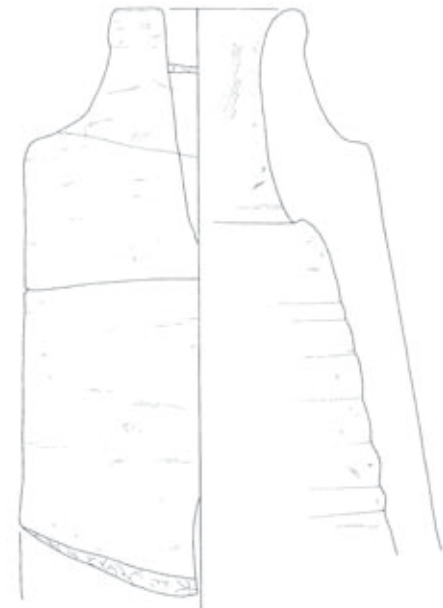
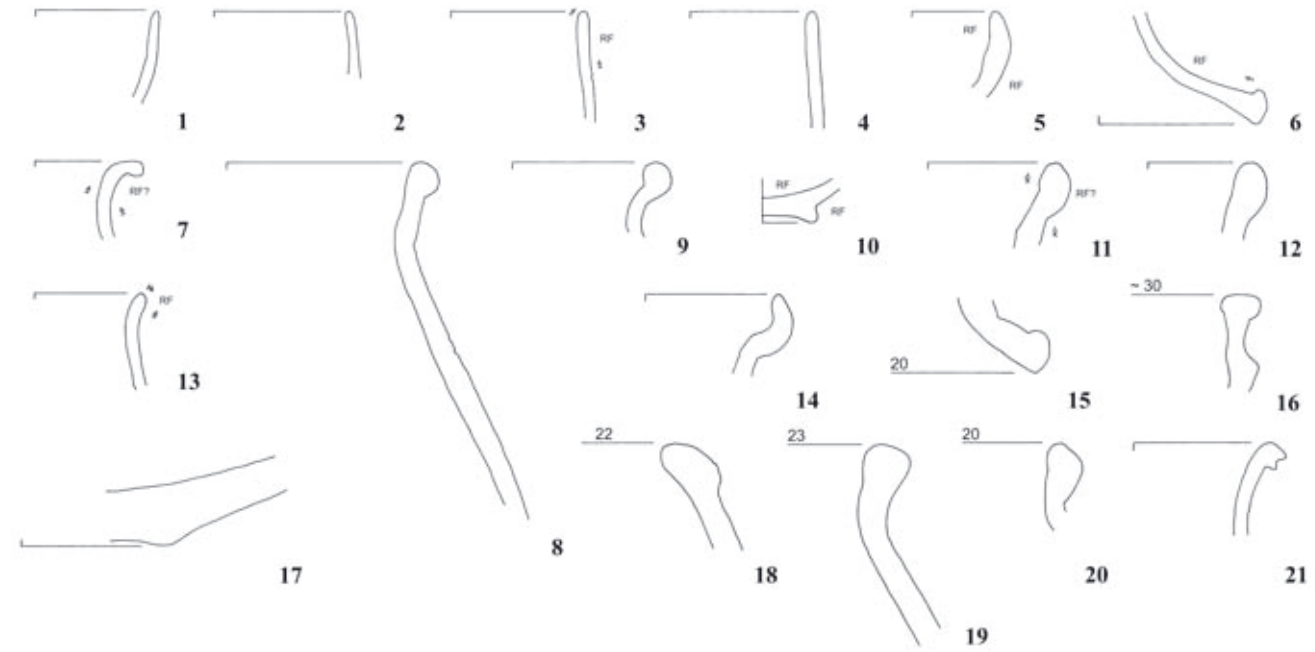

k/61, Gru. 2

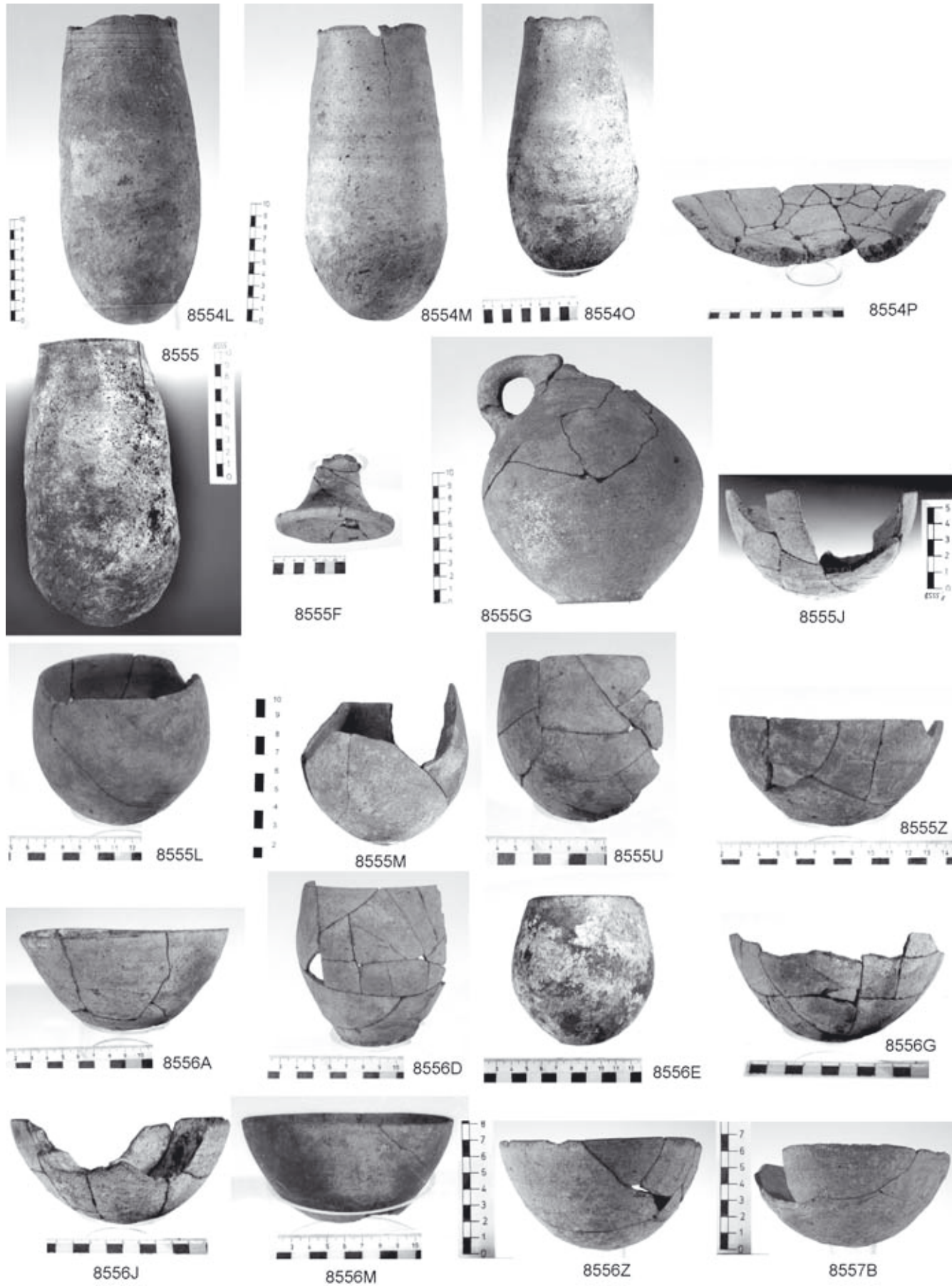

Tafel 184



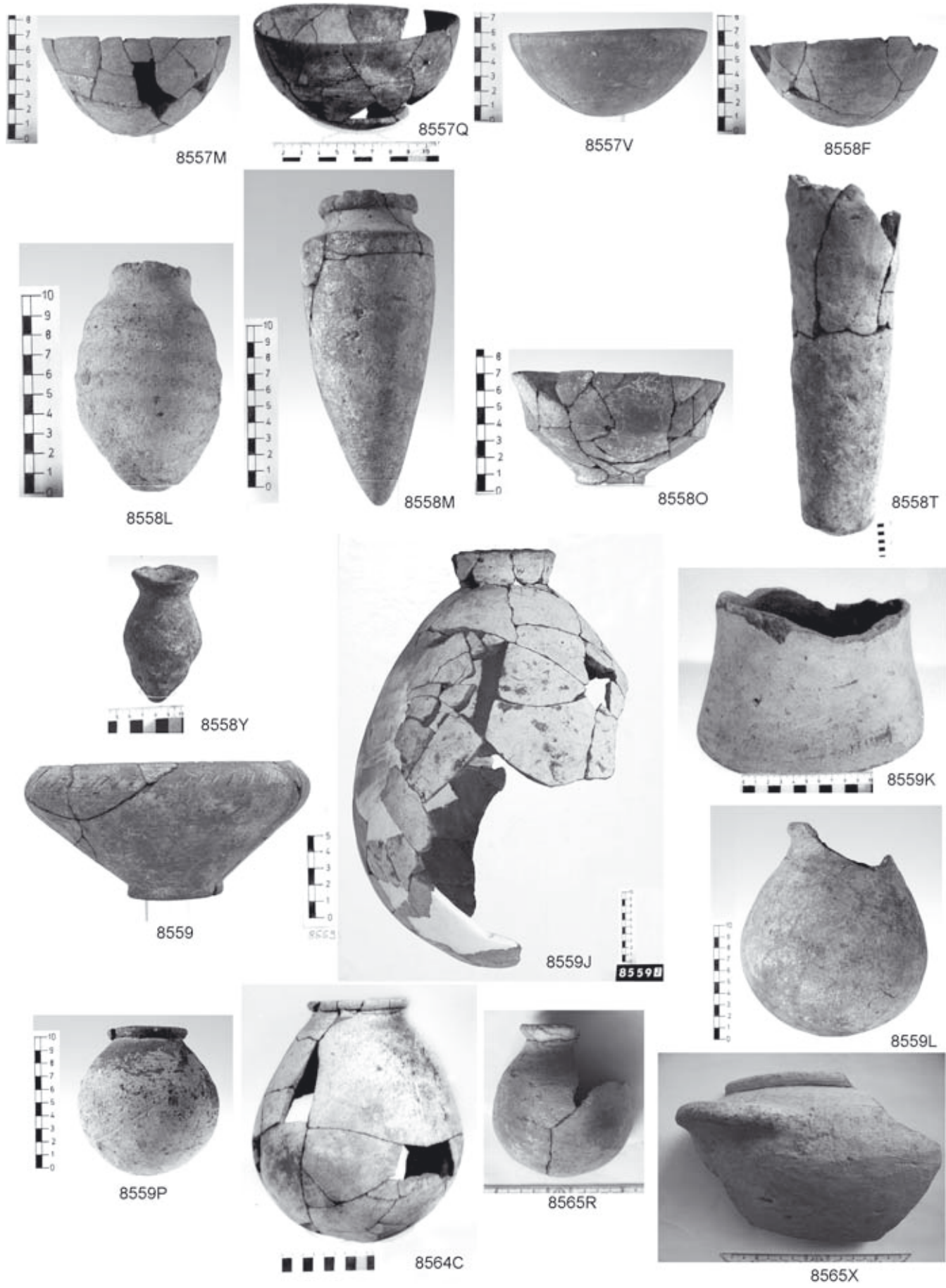

Tafel 185

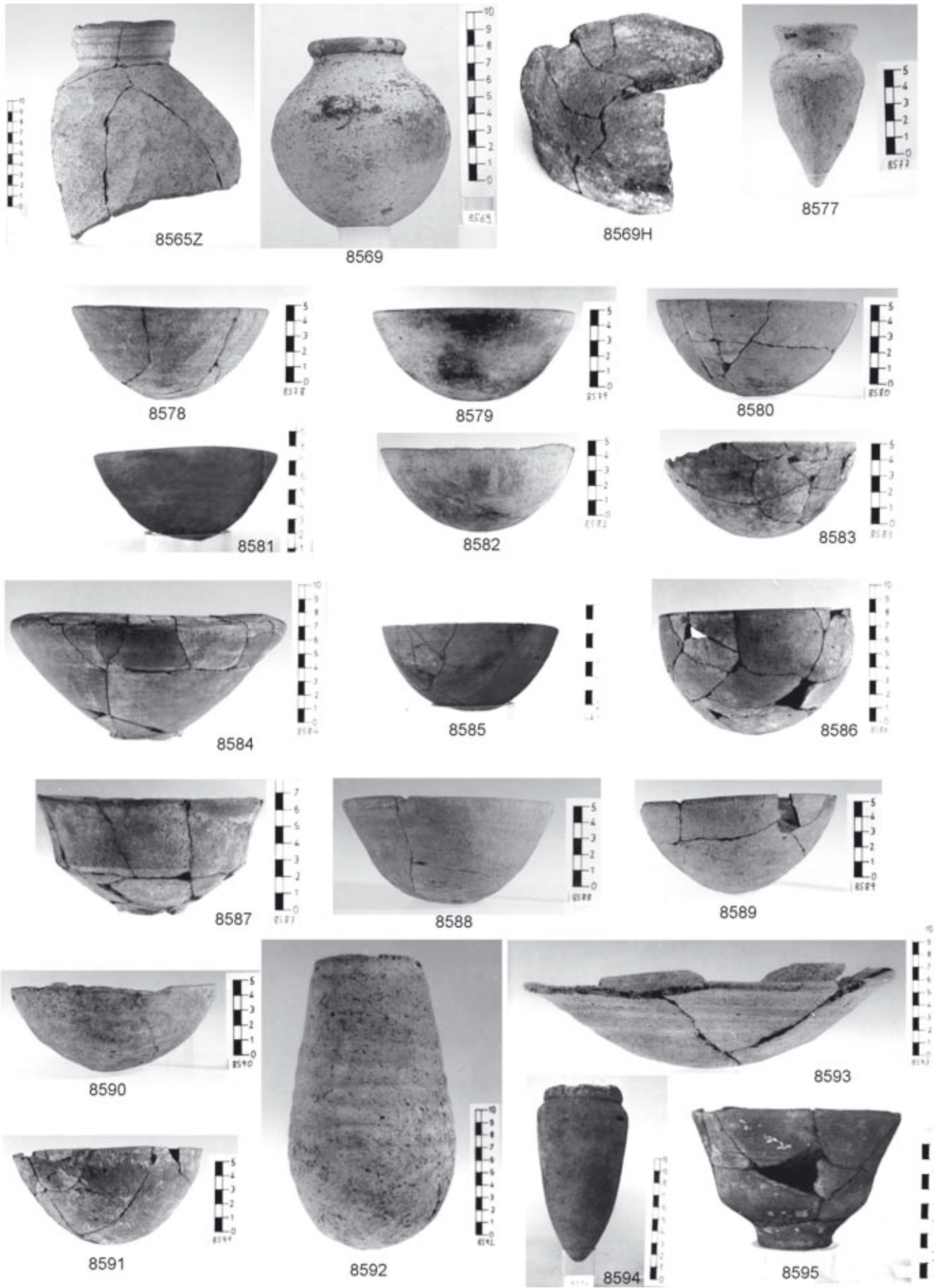

Tafel 186



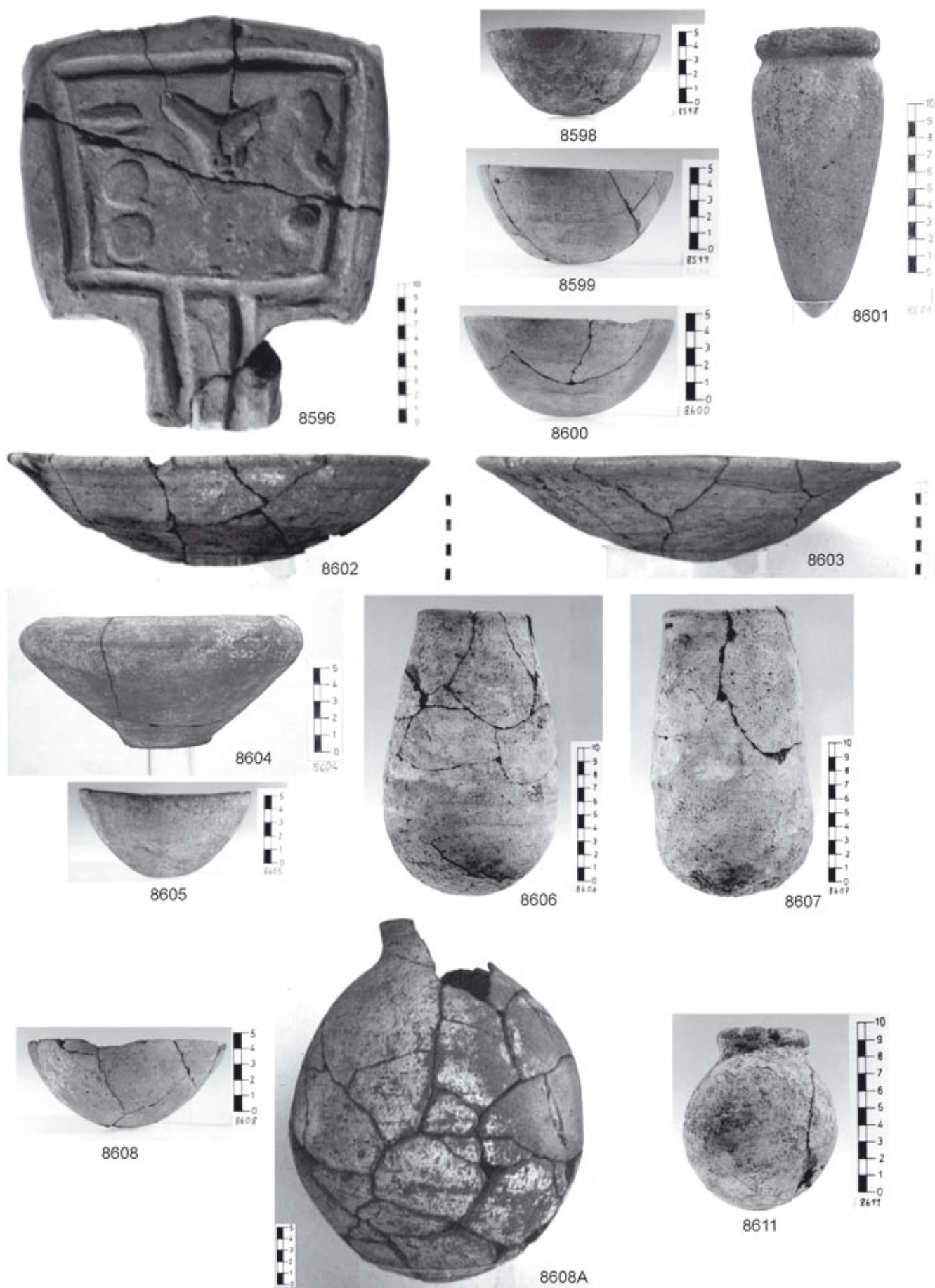

Tafel 187

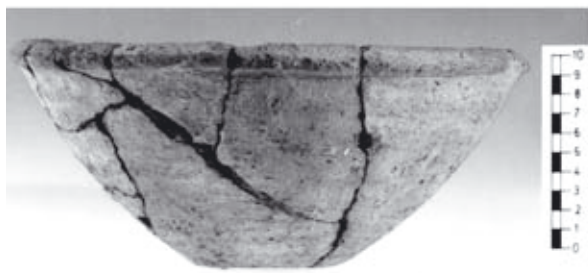

8612-außen



8612-innen



8617

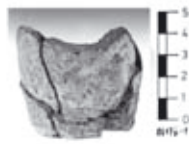

8617J1



8617K

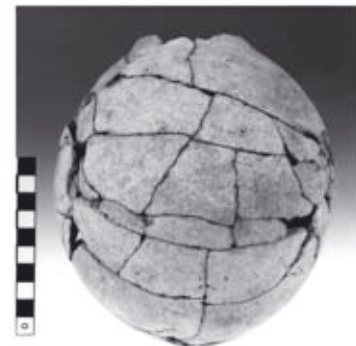

8617L



8617M

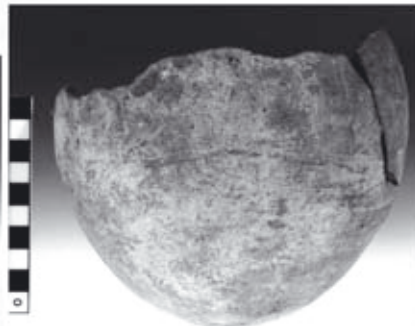

8617N

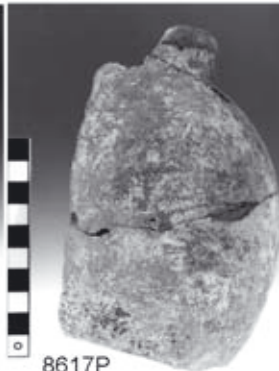

8617P

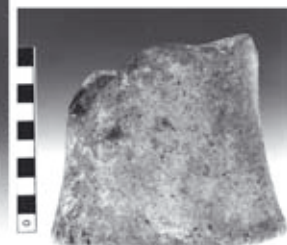

8617Q



8617T



8618

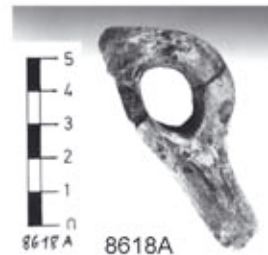

8618A



8618B

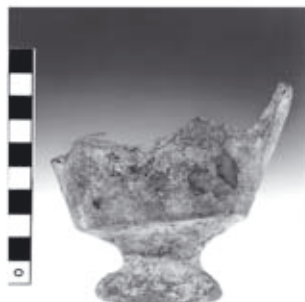

8617U

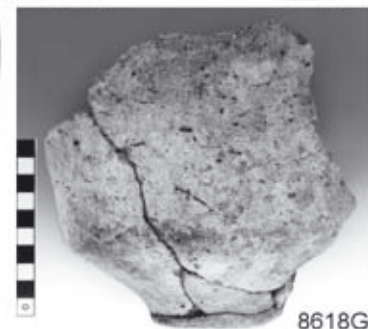

8618G



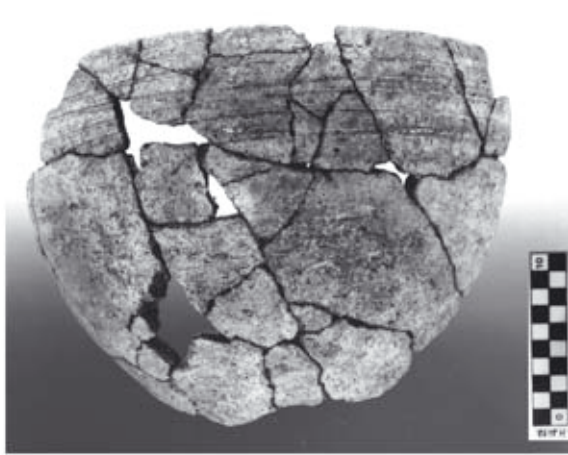

8618H

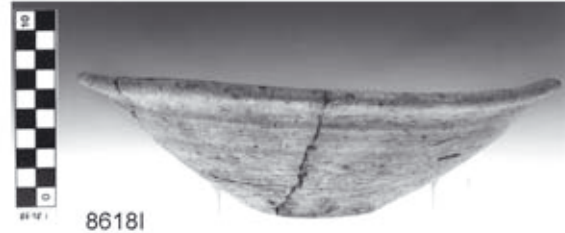

8618I



8618J



8618K

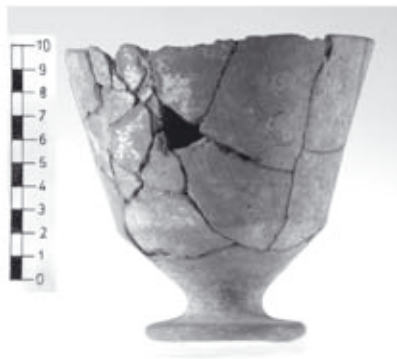

8618L

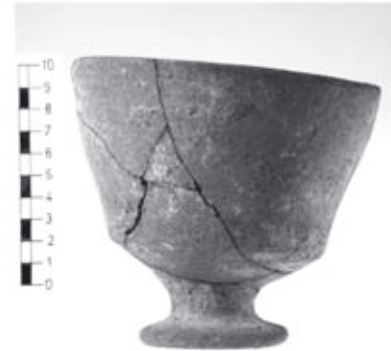

8618M

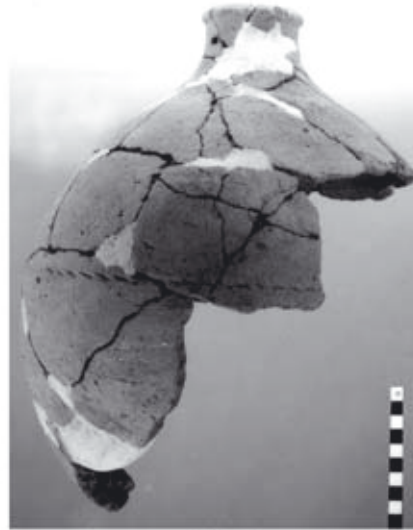

8618O



8618N



8618R



8619



8620



8620E



8620F



08620G



8620H



8620J



8620K



8620L



8620N



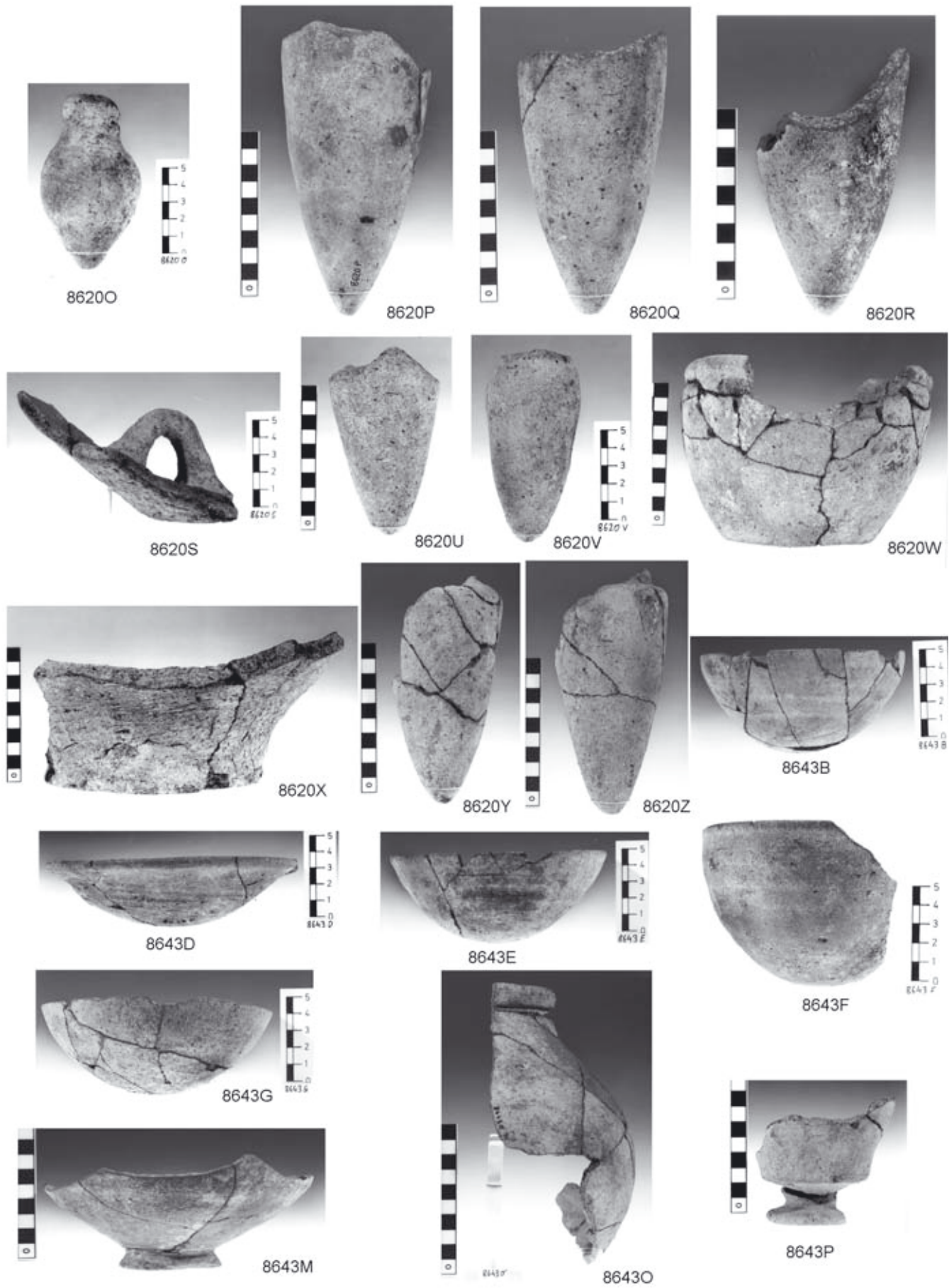

Tafel 191

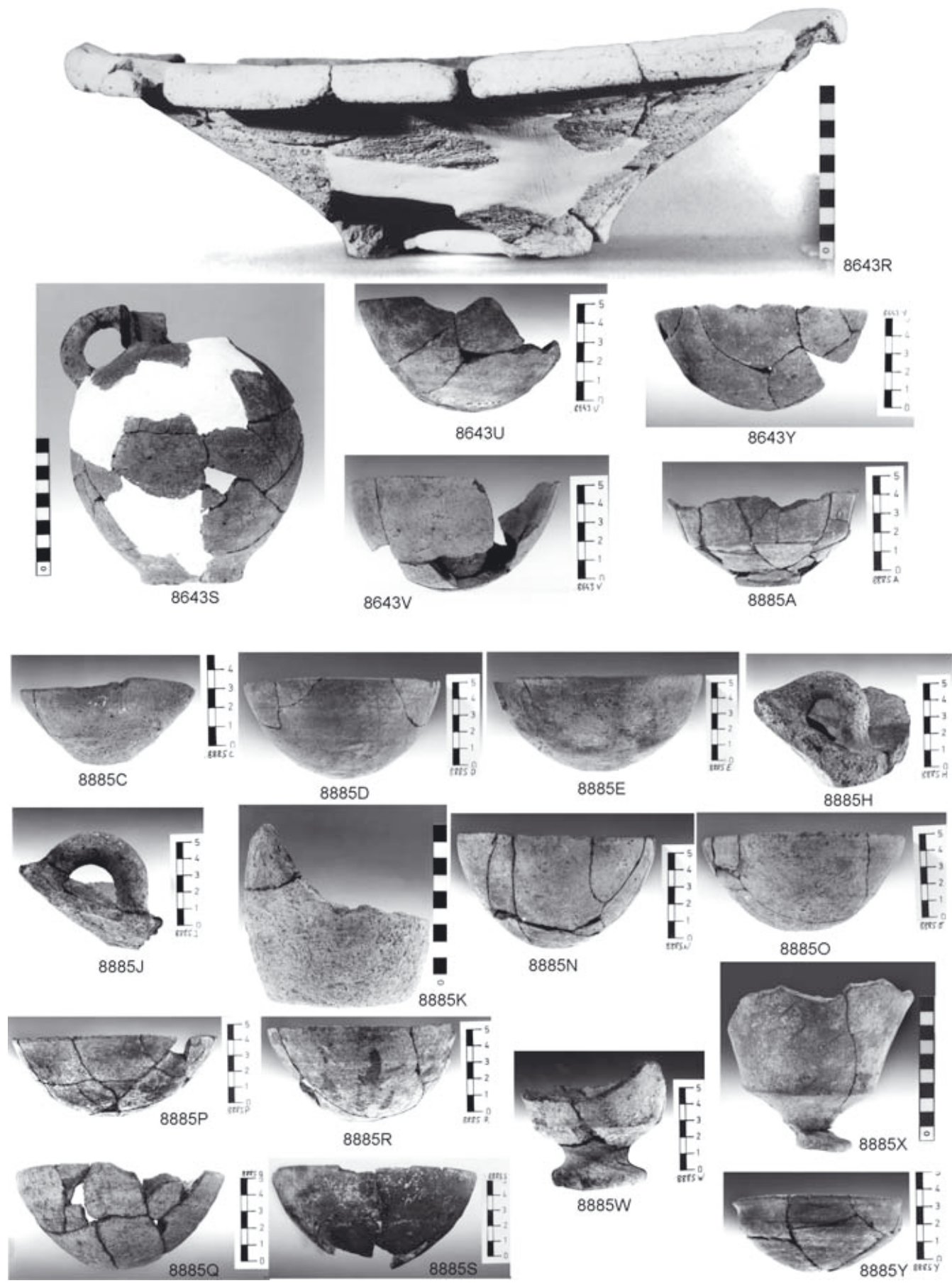

Tafel 192



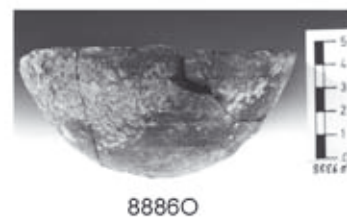
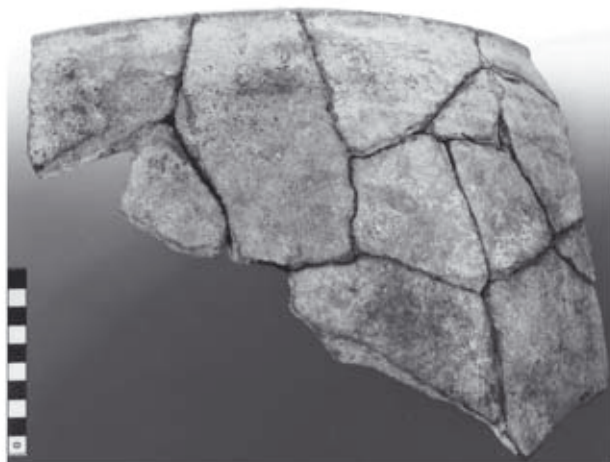
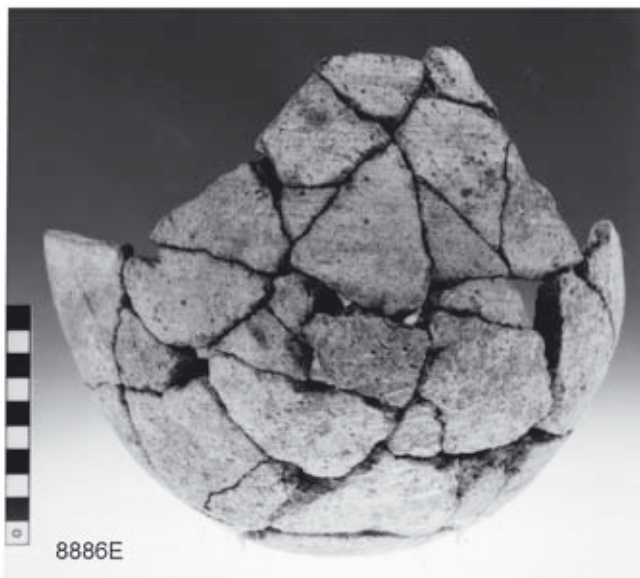

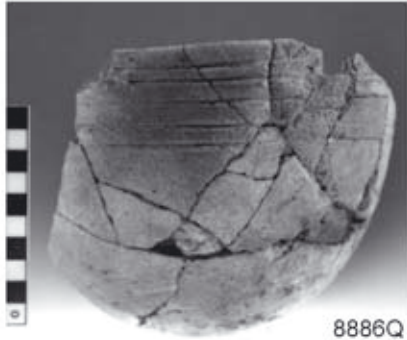

8886Q

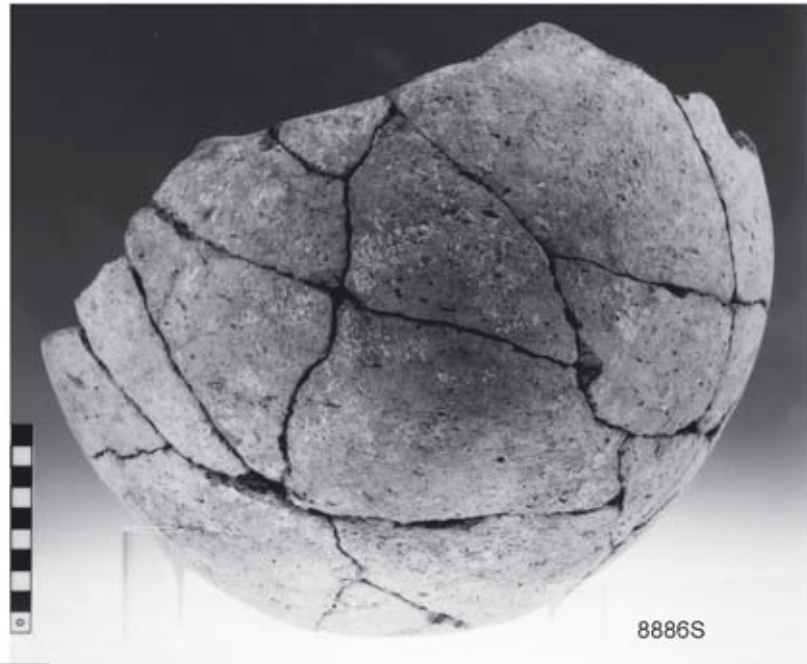

8886S

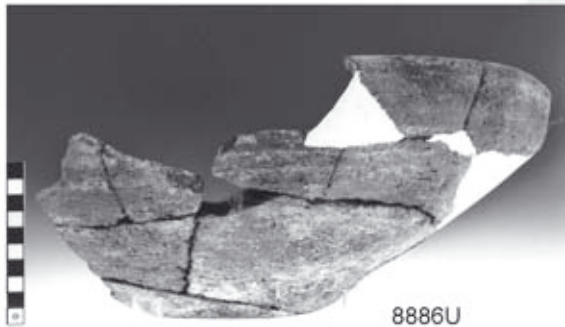

8886U

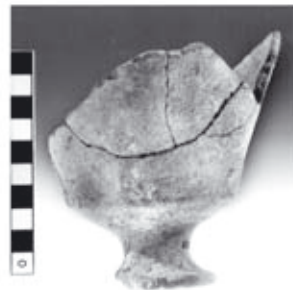

8886W



8887G



8887H



8887J

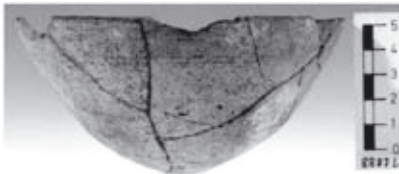

8887L

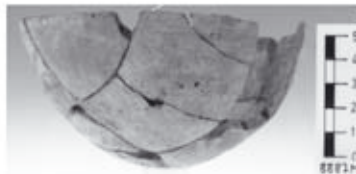

8887M

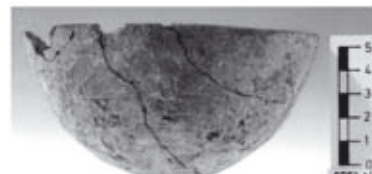

8887N



8887O

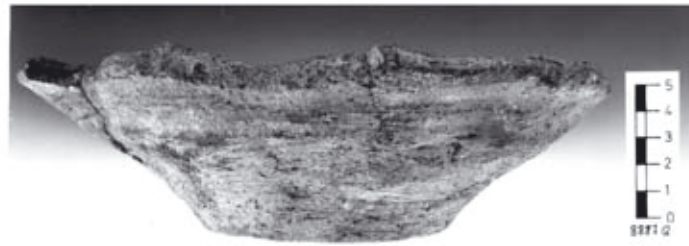

8887Q



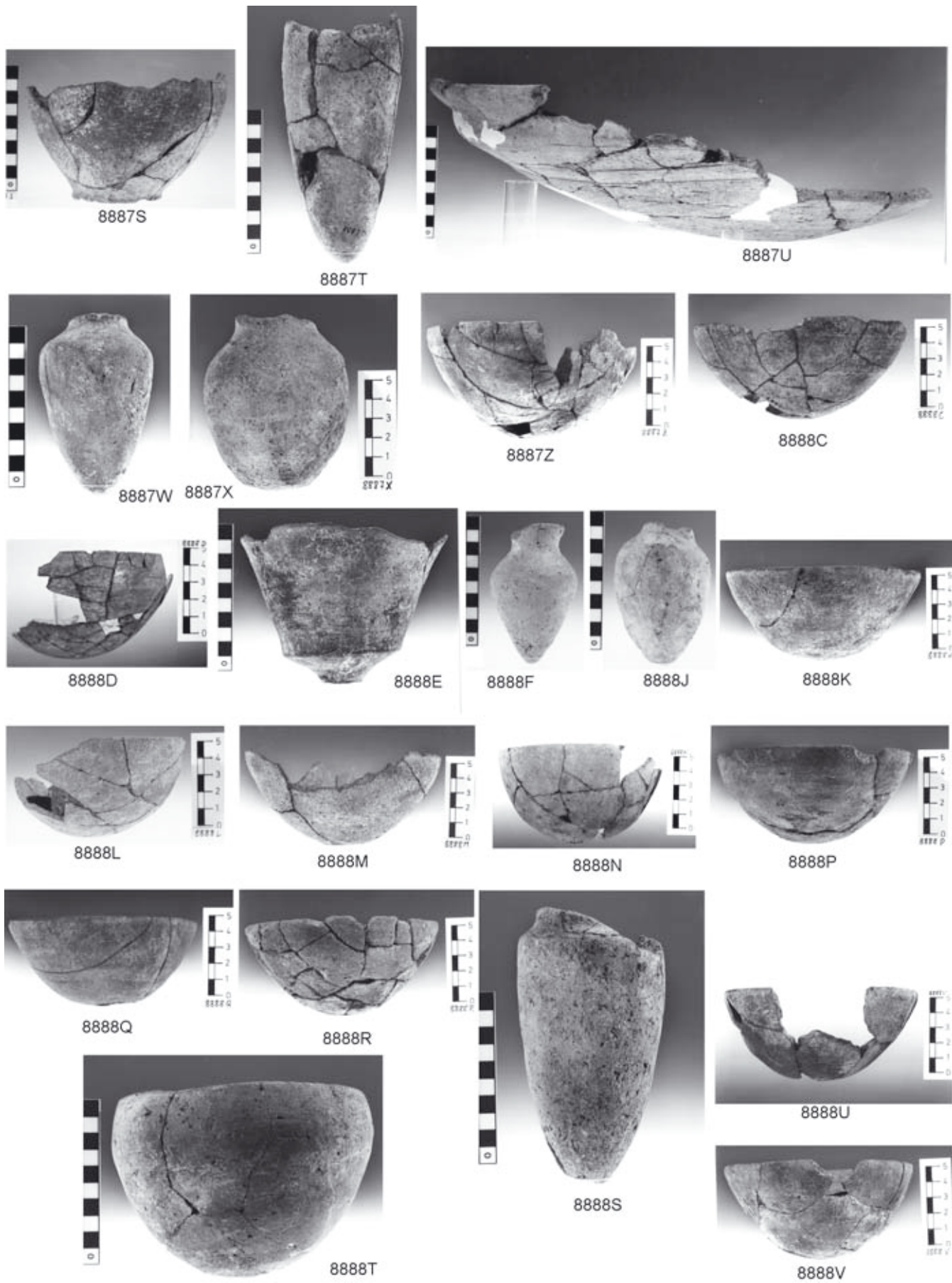

Tafel 195

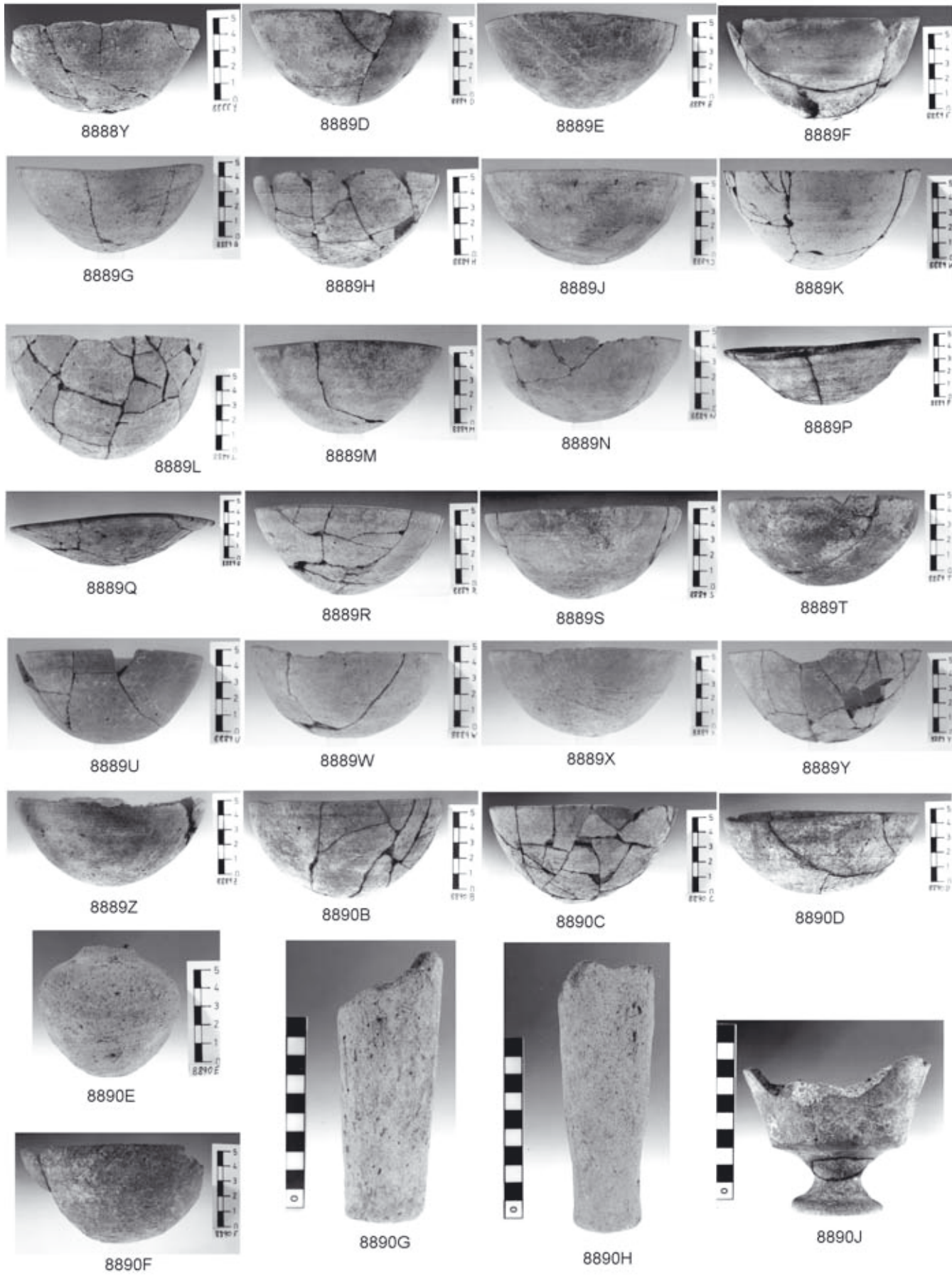

Tafel 196



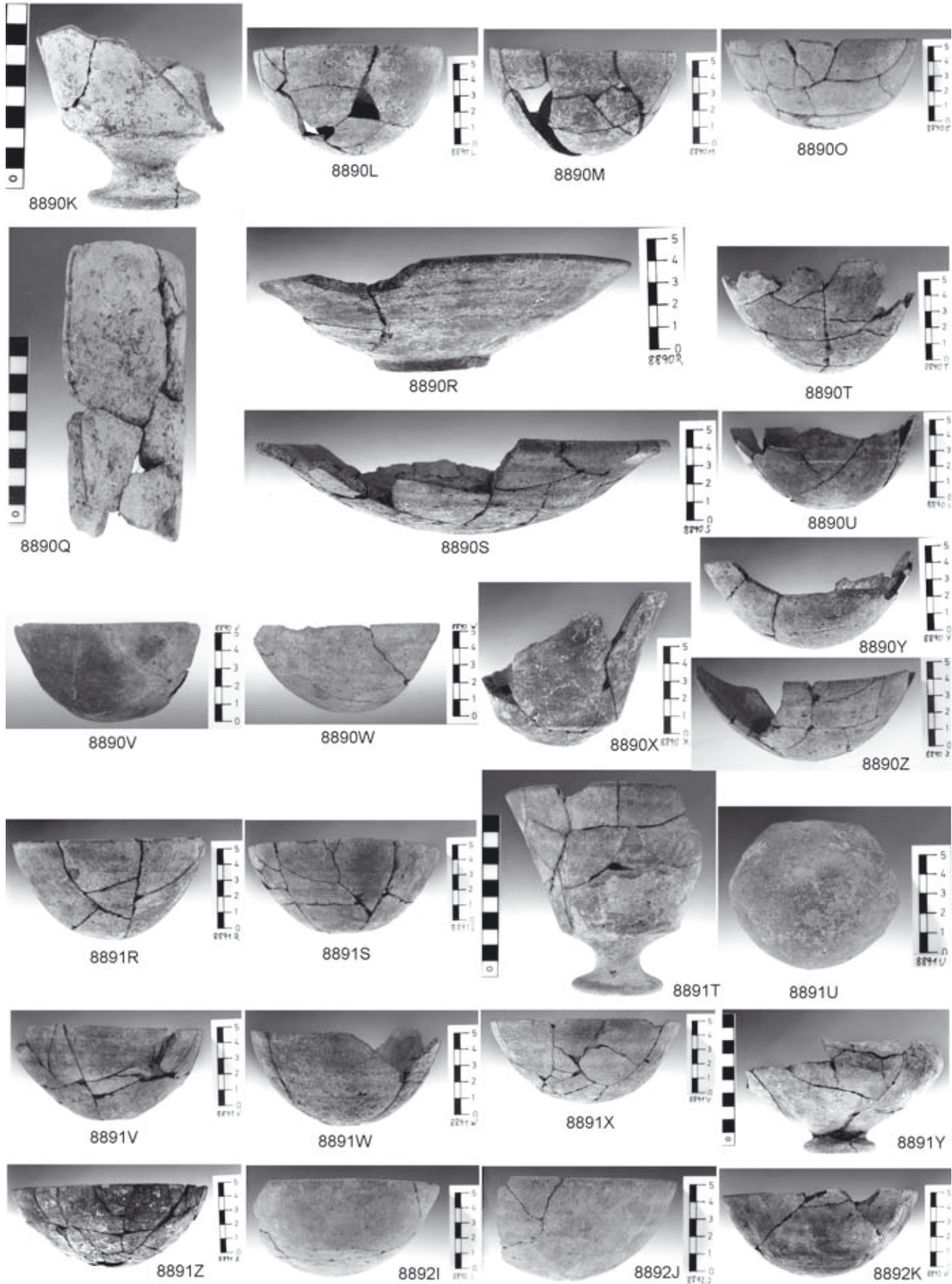

Tafel 197

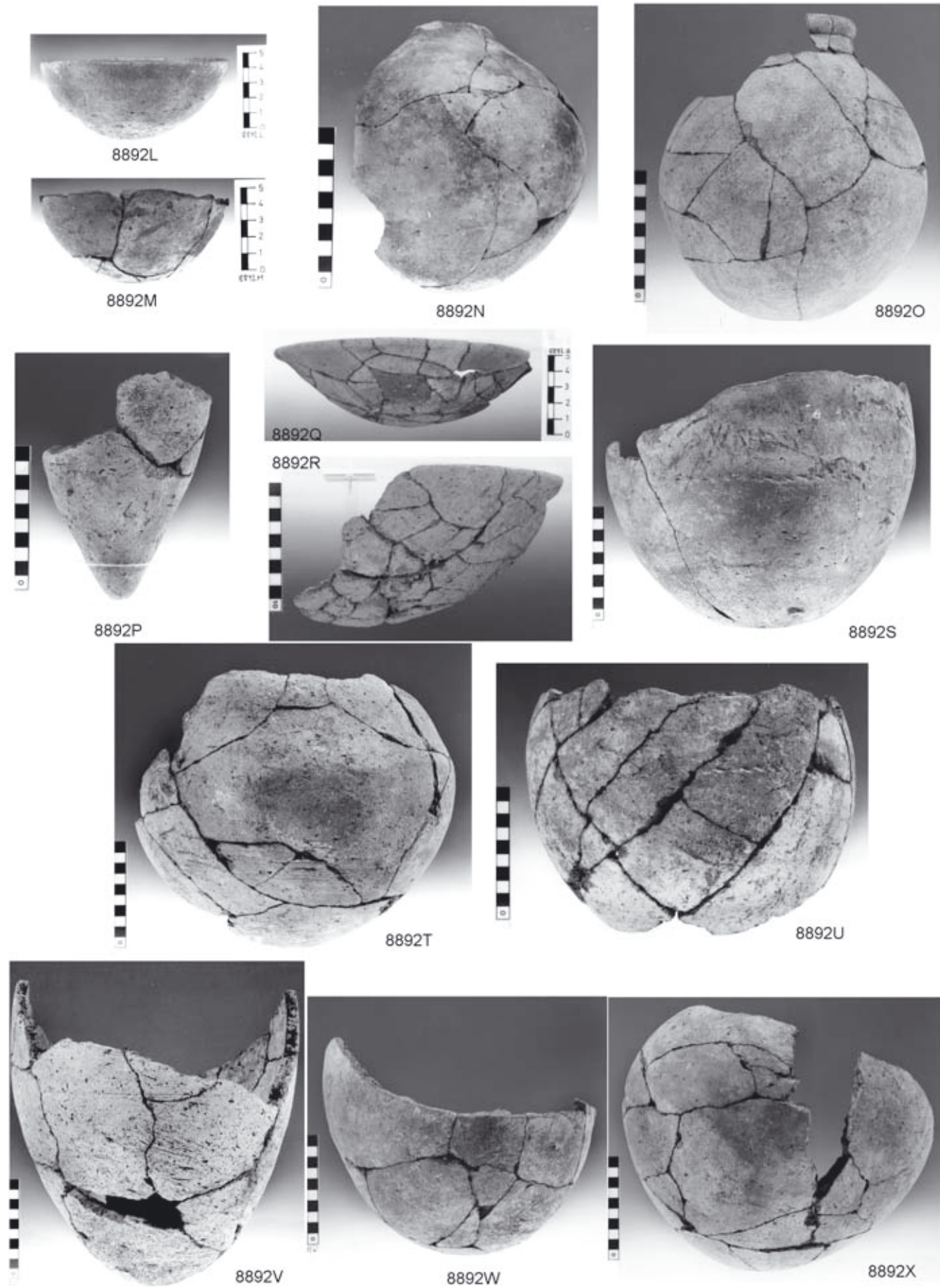



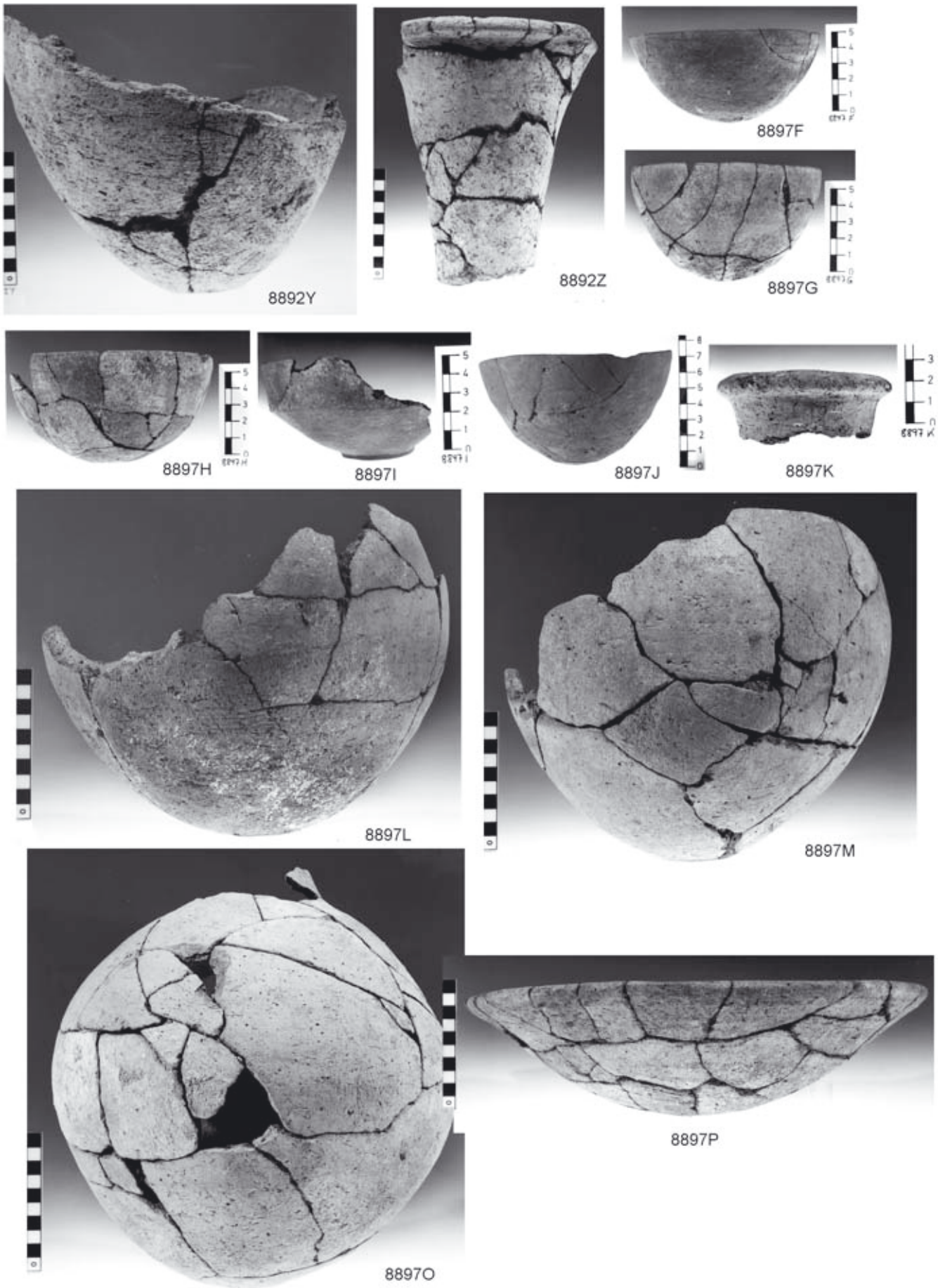

Tafel 199

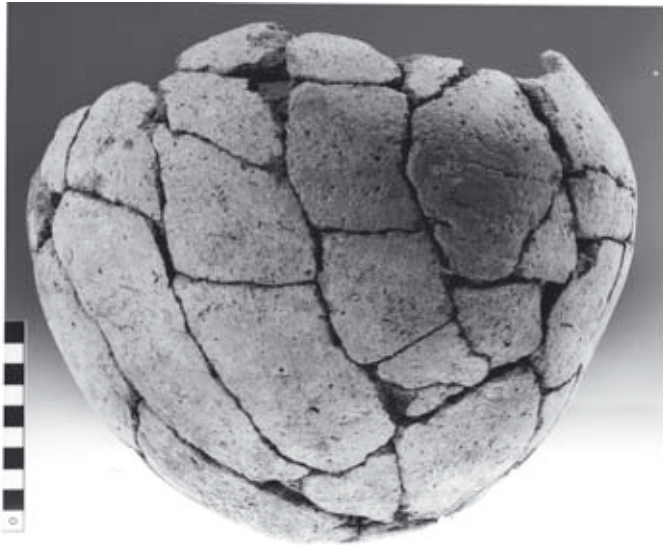

8897Q

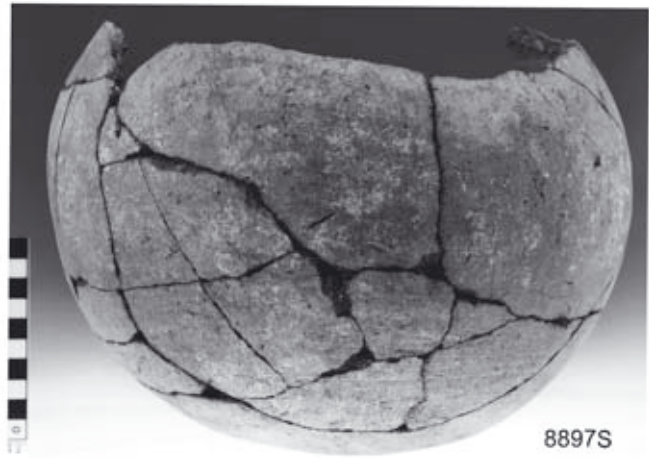

8897S



8897T



8897U

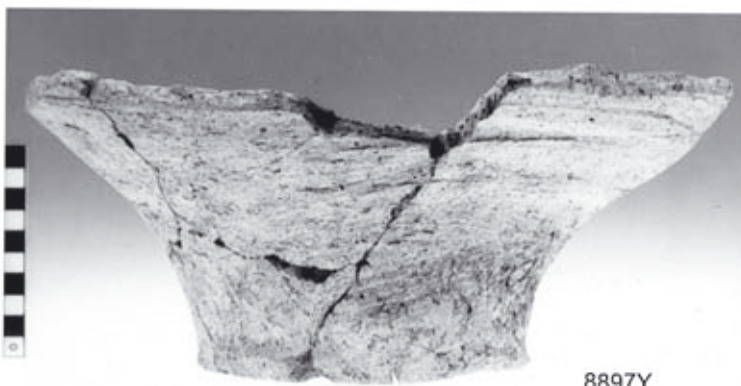

8897Y



8897Z



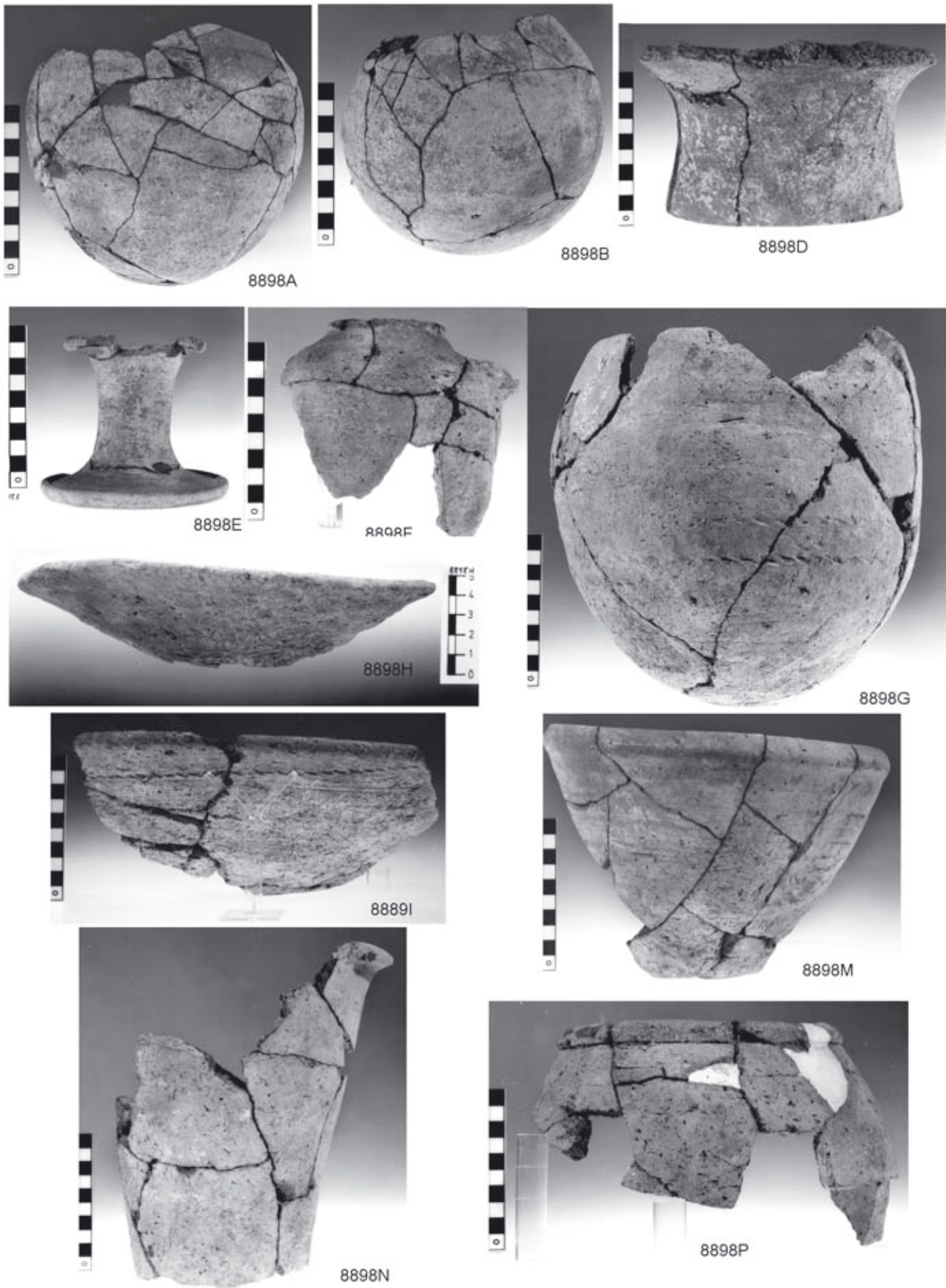

Tafel 201

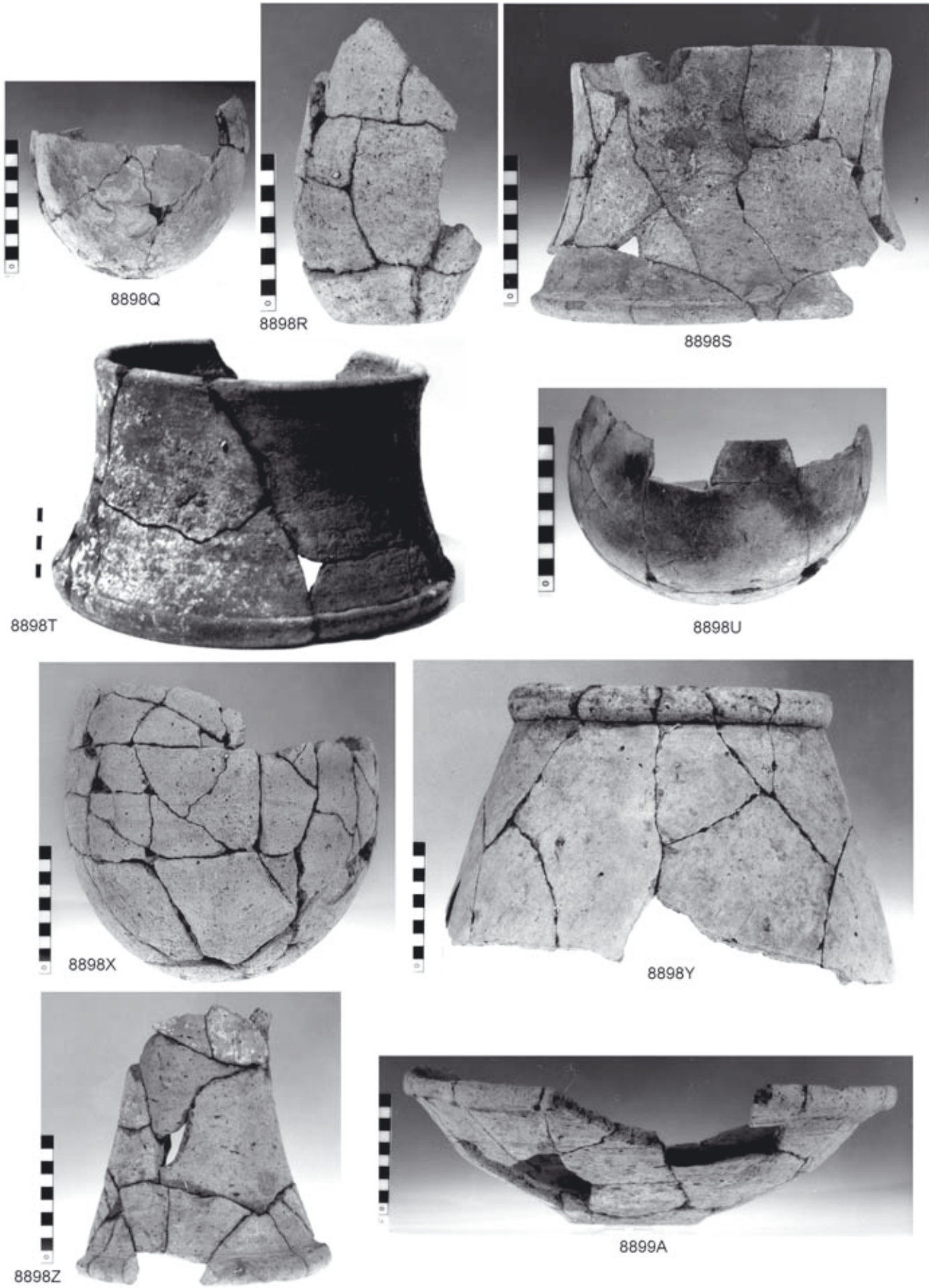



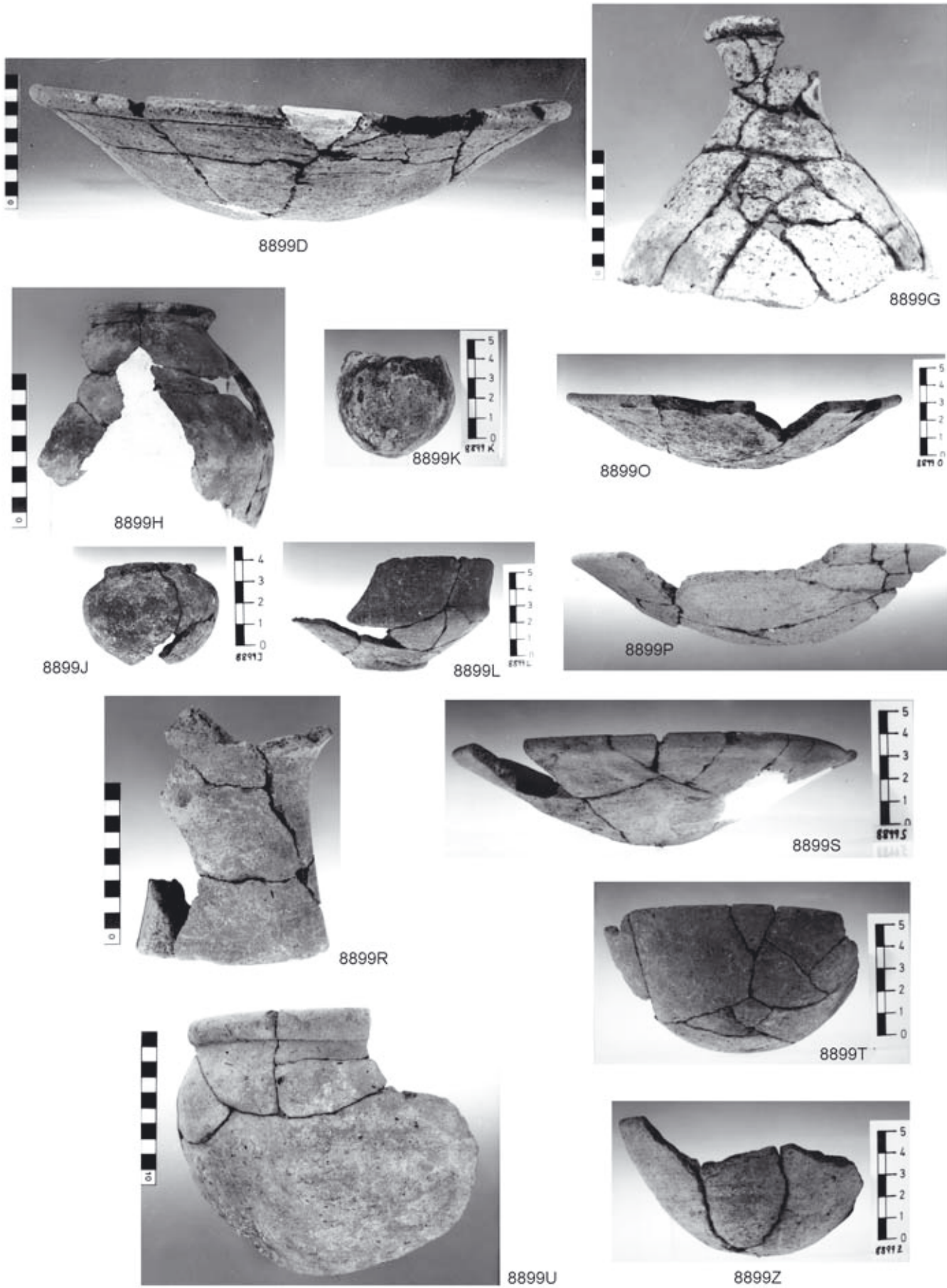

Tafel 203



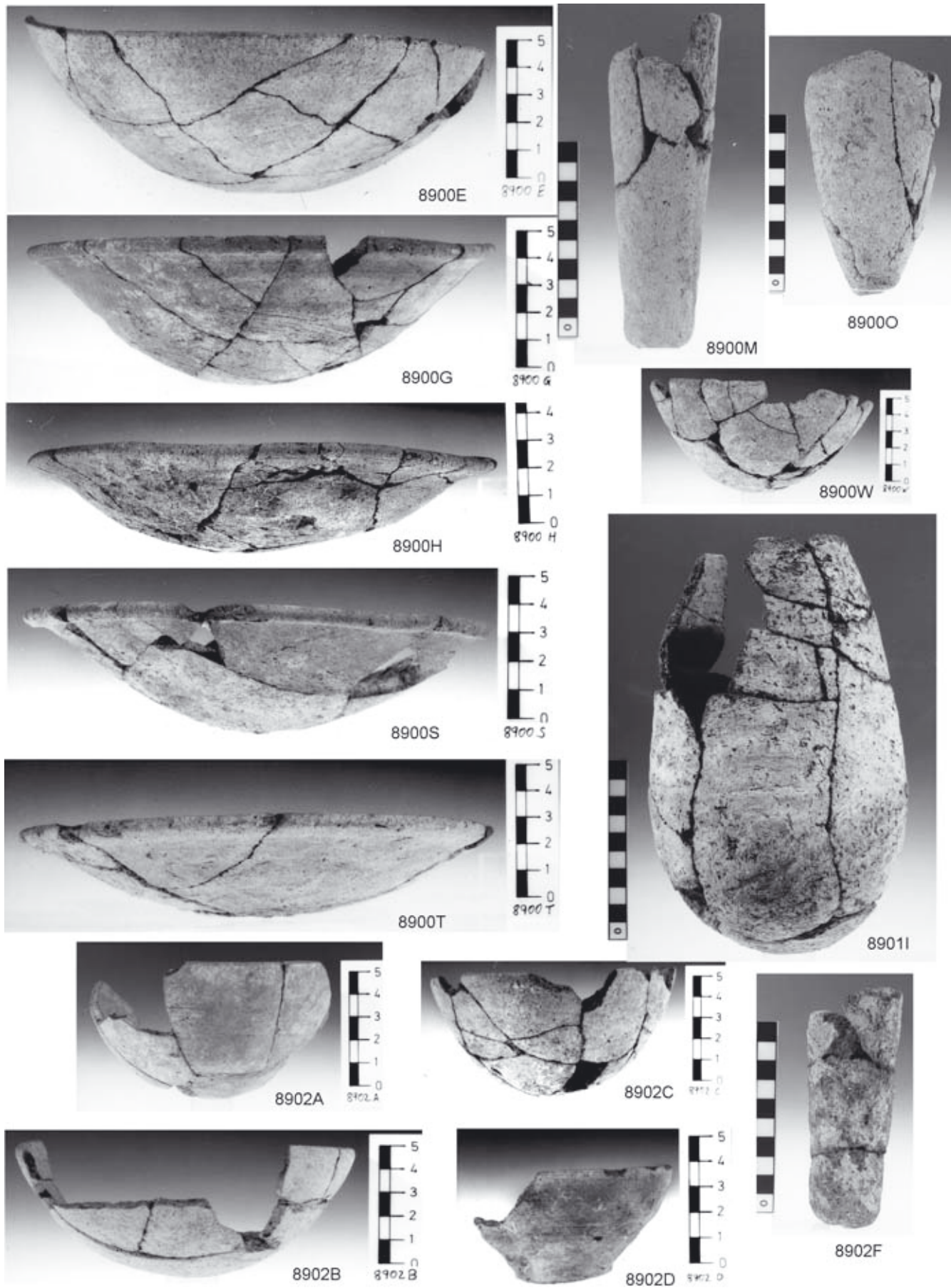

Tafel 204

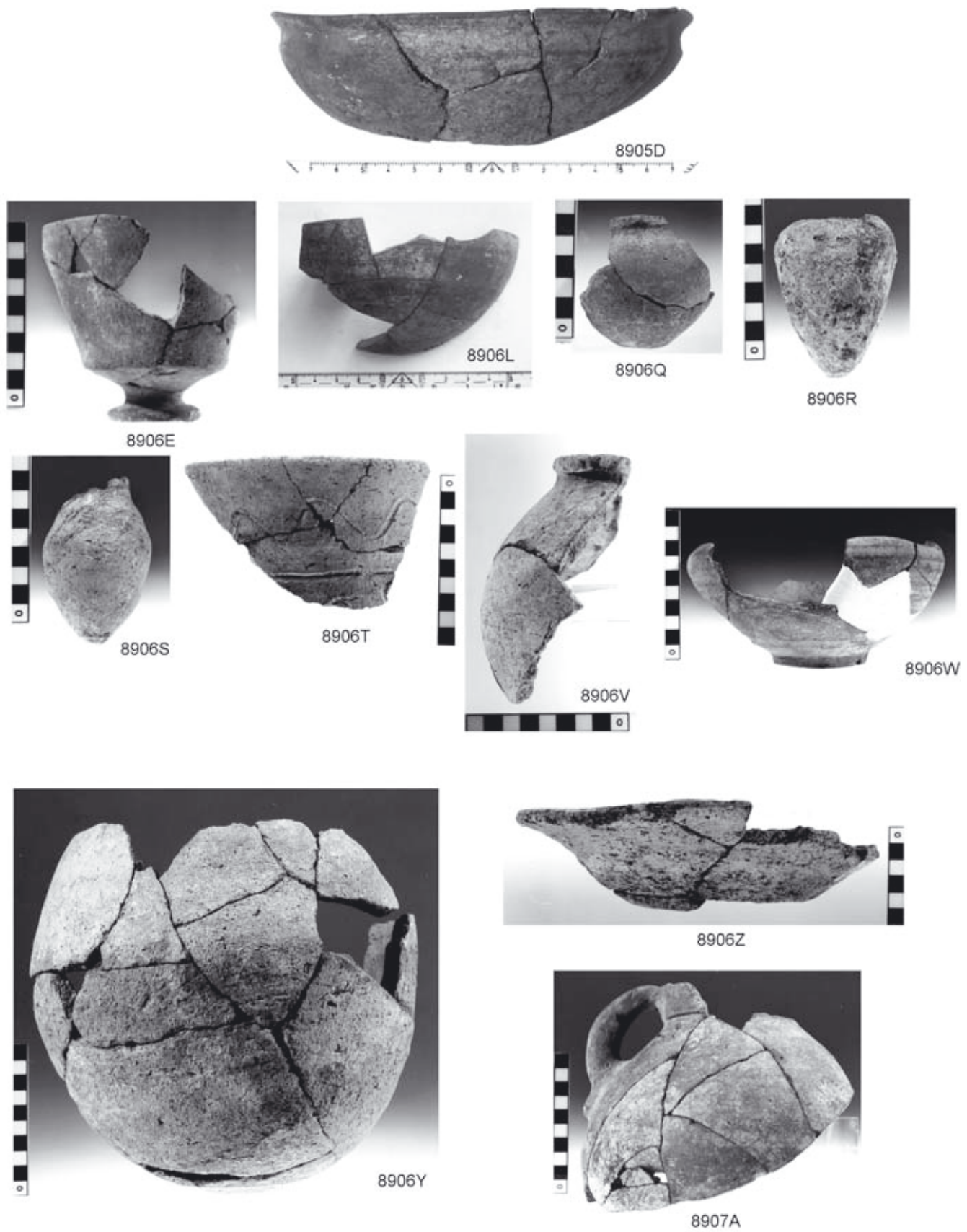

Tafel 205



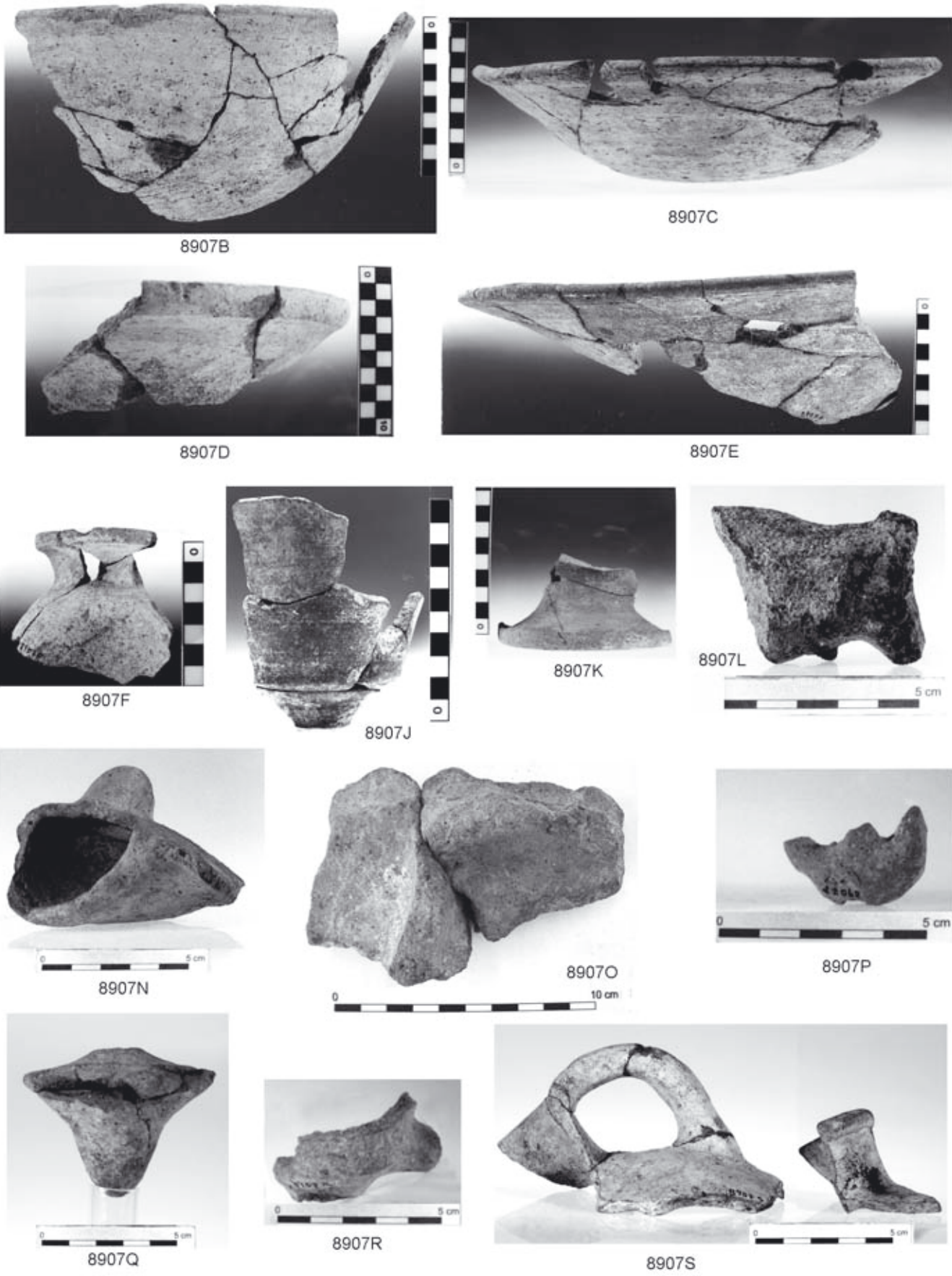

Tafel 206

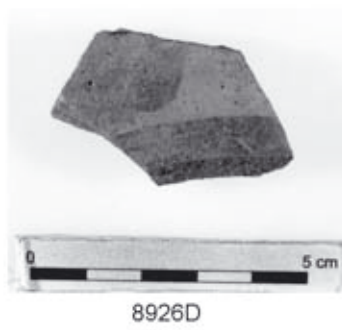
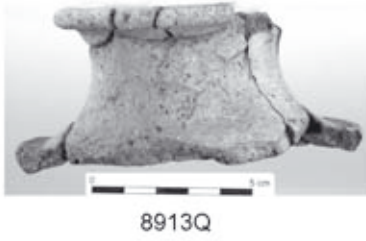
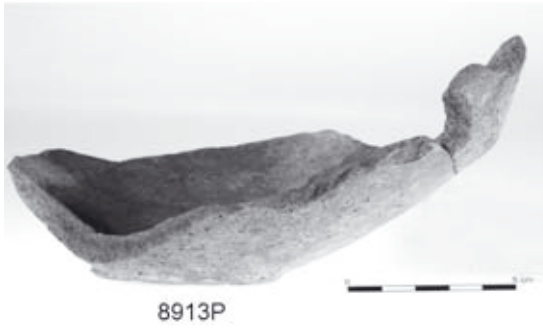
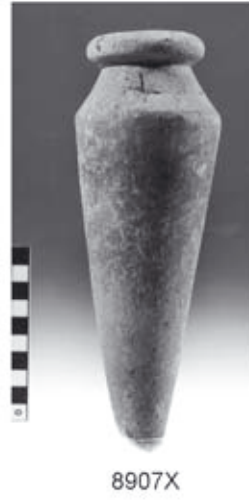

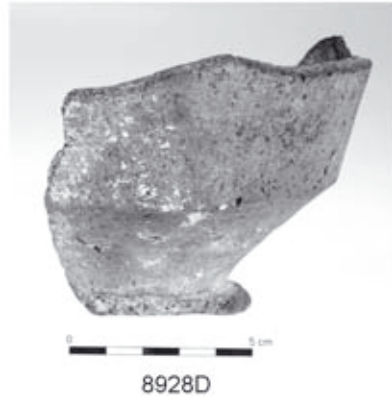

8949I



8949L



8949M



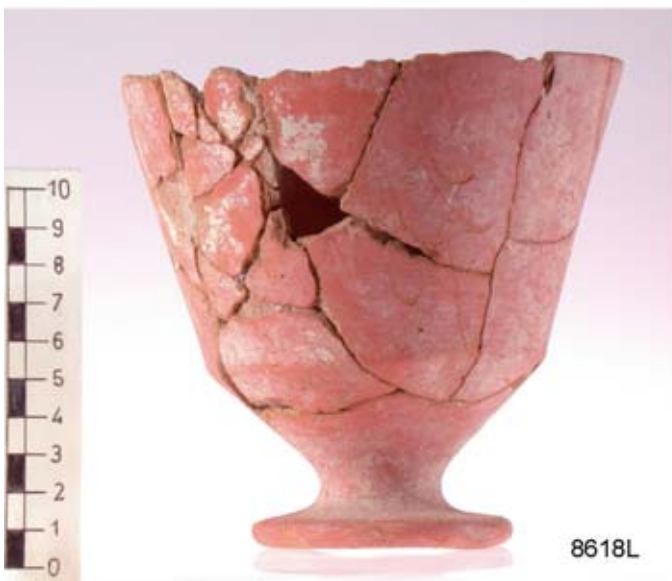

Beispiele für die charakteristische Rotfärbung der Feinkeramik aus der Siedlung der 12. Dynastie von R/I



a) R/I-k/58-60, str. f. (von W)



b) R/I-k/60, Pl. 6, str. f. (von N)



c) R/I-k/58-59, Pl. 12, str. f. (von N)



d) R/I-m/58, Pl. 8, str. f. (von N)



e) R/I-l/61, Pl. 6, str. f. (Gru. 31, Gru. 32, von O)



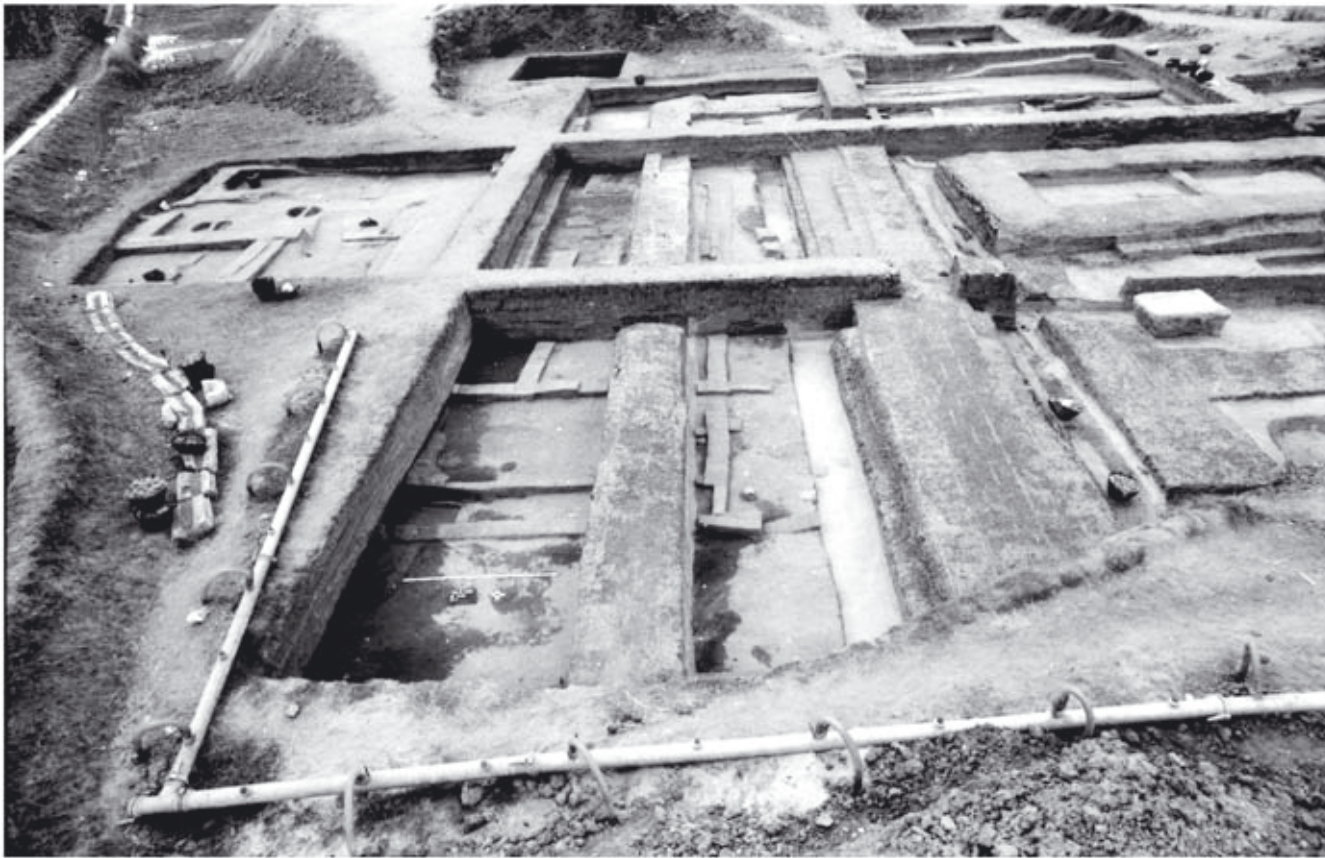

a) Siedlungsreste südlich des Tempelbezirks (n/58-60; o/59); (von O)



b) Siedlungsreste nördlich des Tempelhauses (von N)





a) R/I-k/58-59, Pl. 11, str. e/4 (von N)



b) R/I-k/58, Pl. 10, L386, e/4 (von N)



c) R/I-k/60, Pl. 5, e/3 und e/4 (von O)



d) R/I-l/61, Pl. 5, str. e/4-f; Haus III (von N)



e) R/I-l/61, Pl. 6, str. e/4; Haus III (von N)

Tafel 212 str. e/4: die Hoffläche im N mit Haus IX-X, Haus III



a) R/I-m/58, Pl. 7, str. e/4; Haus XI (von N)



b) R/I-m/61, Pl. 7, str. e/4 (z.T. str. e/3); Haus V (von O)

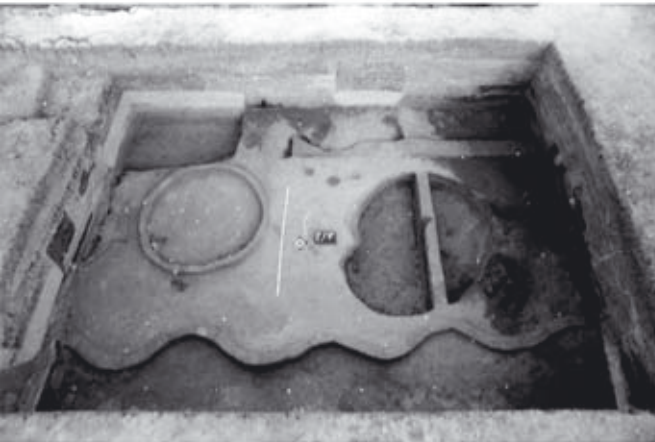

c) R/I-n/58, Pl. 6, str. e/4; Haus XIII (von W)



d) R/I-n/59, Pl. 4, str. e/4; Haus XIII - XIV (von O)



e) R/I-n/60, Pl. 8, str. e/4; Haus XIV (von W)



f) R/I-n/61, Pl. 6, str. e/4 und e/3; Haus VII (von S)





a) R/I-k/58-59, Pl. 10, e/3 (von N)



b) R/I-k/58-59, Pl. 10, Gru. 18, e/3 (von N)



c) R/I-k/59-O, Pl. 5, str. e/3 (von N)



d) R/I-k/60, Pl. 4, e/3 (z.T. e/2) (von N)



e) R/I-l/61, Pl. 3, str. e/3, Haus III (von N)

Tafel 214 str. e/3: die Hoffläche im N mit Haus IX-X, Haus III





a) R/I-m/58, Pl. 5, str. e/3; Haus XI (von N)



b) R/I-m/61, Pl. 6, str. e/3; Haus V (von O)



c) R/I-n/58, Pl. 5, str. e/3; Haus XIII (von N)



d) R/I-n/59, Pl. 7, str. e/3.2; Haus XIII (von O)

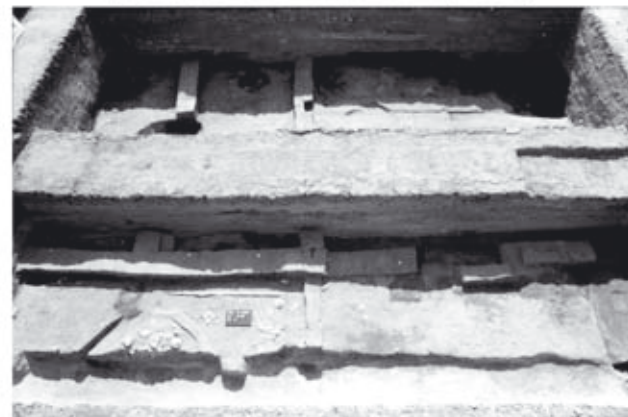

e) R/I-n/59, Pl. 6, str. e/3.1; Haus XIII - XIV (von N)



f) R/I-n/60, Pl. 7, str. e/3; Haus XIV (von N)



g) R/I-n/60, Pl. 7, Gru. 10, str. e/3; Haus XIV (von N)





a) R/I-k/58-59, Pl. 9, str. e/2 (von N)



b) R/I-k/59-O, Pl. 4, str. e/2 (von N)



c) R/I-k/60, Pl. 3, str. e/2 (von O)



d) R/I-k/60, Pl. 3, L.246, str. e/2 (von O)

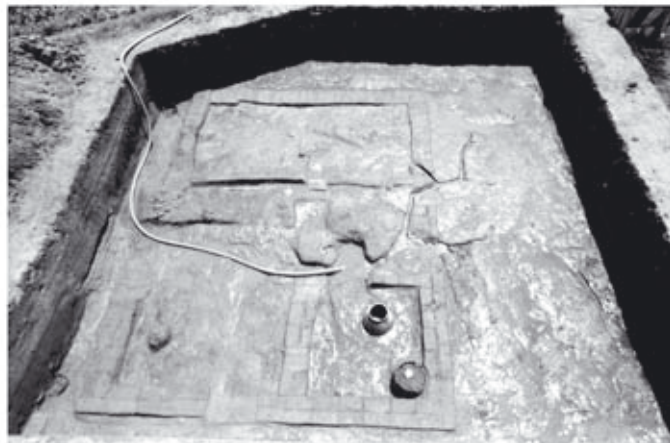

e) R/I-k/61, Pl. 4, str. e/2; Haus I (von W)



f) R/I-l/61, Pl. 2, str. e/2; Haus III (von O)

Tafel 216 str. e/2: die Hoffläche im N mit Haus IX-X, Haus I, Haus III





a) R/I-m/58, Pl. 4, str. e/2; Haus XI (von N)

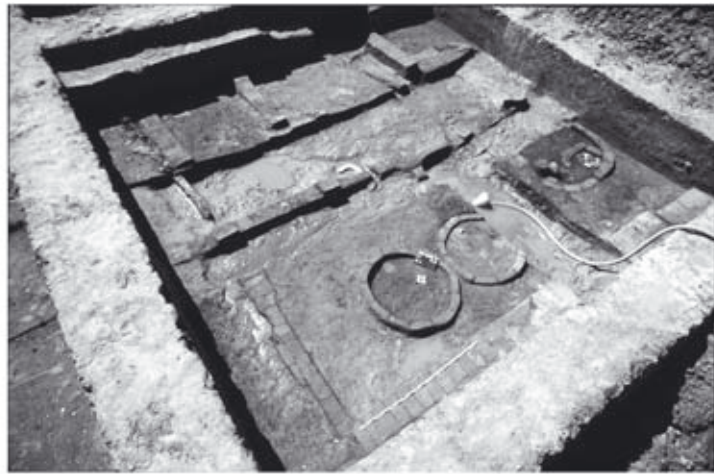

b) R/I-m/61, Pl. 5, str. e/2; Haus V (von O)

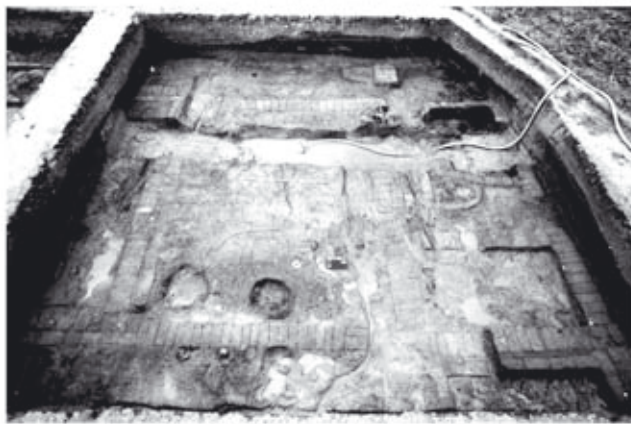

c) R/I-m/62, Pl. 7, str. e/2; Haus VI (von S)



d) R/I-n/58, Pl. 4, str. e/2; Haus XIII (von S)



g) R/I-n/60, Pl. 6, str. e/2; Haus XIV (von O)



f) R/I-n/59, Pl. 5-6, L.273, str. e/2-3; Haus XIII (von S)

e) R/I-n/59, Pl. 5, str. e/2; Haus XIII - XIV (von O)



h) R/I-n/61, Pl. 5, str. e/2; Haus VII (von O)

Tafel 217 str. e/2: Haus V, Haus VI, Haus VII, Haus XI, Haus XIII, Haus XIV





a) R/I-k/58-59, Pl. 8, str. e/1 (von N)

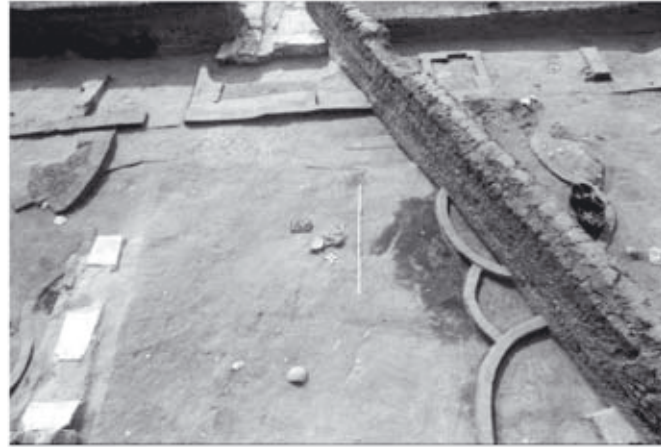

b) R/I-k/59-O, Pl.3, str. e/1 (von N)



c) R/I-k/60, Pl. 2, str e/1 (und d) (von N)

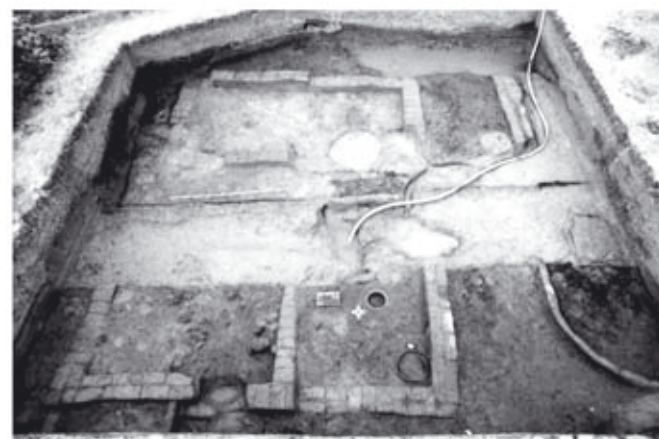

d) R/I-k/61, Pl. 3, str. e/1; Haus I (von W)

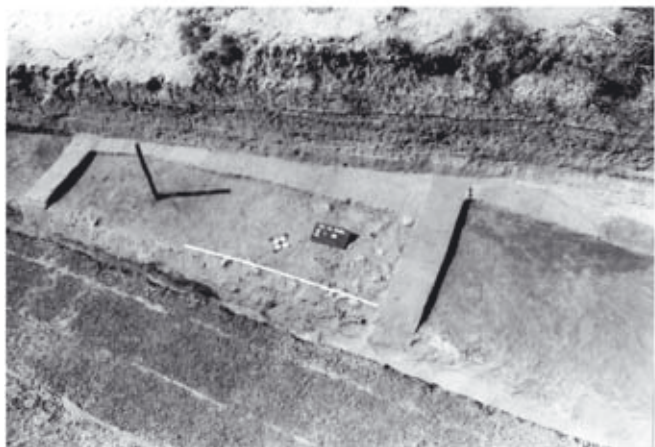

e) R/I-l/58, Pl. 7, str. e/1; Haus IX/X (von O)



f) R/I-l/59, Pl. 4, str. e/1; Haus IX/X (von O)

Tafel 218 str. e/1: die Hoffläche im N mit Haus IX/X, Haus I, Haus III





a) R/I-m/58, Pl. 3, str. d und e/1; Haus XI/XII (?) (von N)

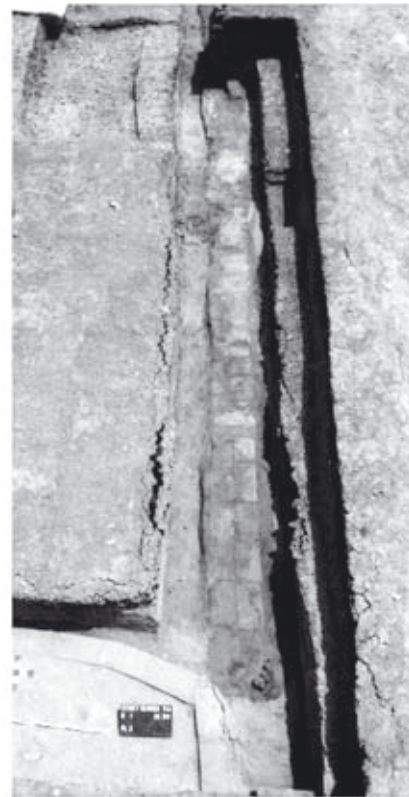

b) R/I-m/59, Pl. 2, str. e/1 (unter c);  
Haus XI/XII (?) (von W)



c) R/I-m/59, Pl. 1, str. e/1 (unter c);  
Haus XI/XII (?) (von S)



d) R/I-m/60, Pl. 2, str. e/1 (unter c); Haus XI/XII (?) (von S)



e) R/I-m/60, Pl. 1, str. e/1 (unter c) mit 8569H;  
Haus XI/XII (?) (von O)



f) R/I-m/61, Pl. 4, str. e/1; Haus V (von N)



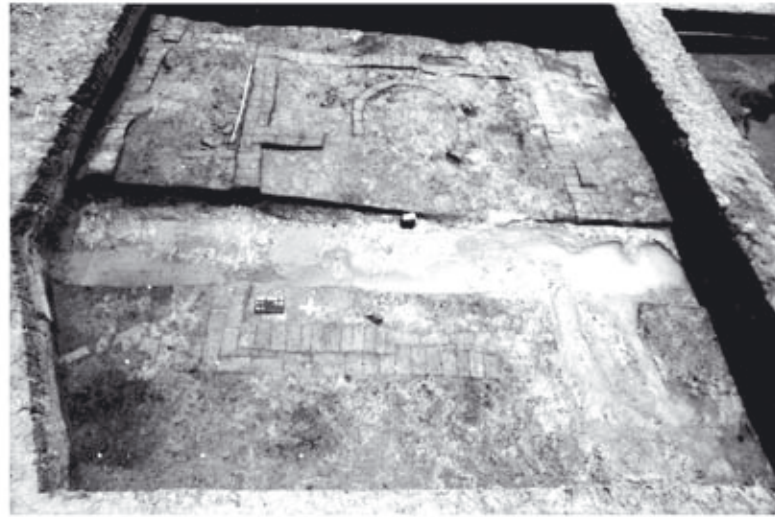

a) R/I-m/62, Pl. 4, str. e/1.1; Haus VI (von N)

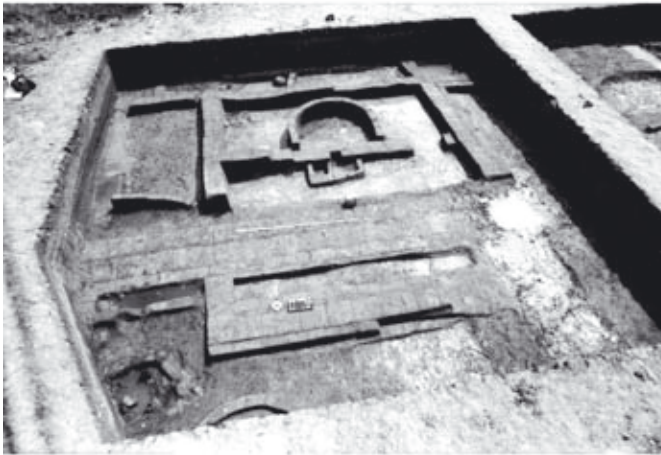

b) R/I-m/62, Pl. 6, str. e/1.2; Haus VI (von N)



c) R/I-m/62, Pl. 6, str. e/1.2; Haus VI (von O)



d) R/I-m/62, Pl. 6, L31, str. e/1; Haus VI (von O)



e) R/I-m/62, Pl. 6, L31, str. e/1; Haus VI (von N)





a) R/I-n/58, Pl. 3, str. e/1 (unter c); Haus XIII (von W)

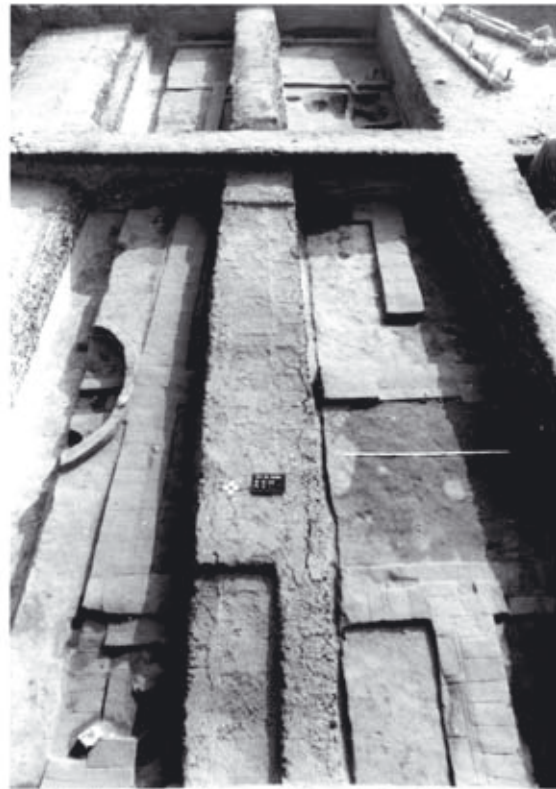

b) R/I-n/59, Pl. 4, str. e/1; Haus XIII - XIV (von W)



c) R/I-n/60, Pl. 5, str. e/1; Gasse mit Haus XIV (von O)



d) R/I-n/61, Pl. 4, str. e/1; Haus VII (von W)



e) R/I-n/62, Pl. 4, str. e/1;  
zw. Haus VI und VIII (von N)





a) R/I-o/59, Pl. 6, str. e/3  
(von W)



b) R/I-o/59, Pl. 5, str. e/2  
(von W)



c) R/I-o/59, Pl. 4, str. e/1  
(von W)

d) R/I-o/59, Pl. 3, str. c/2  
(von N)

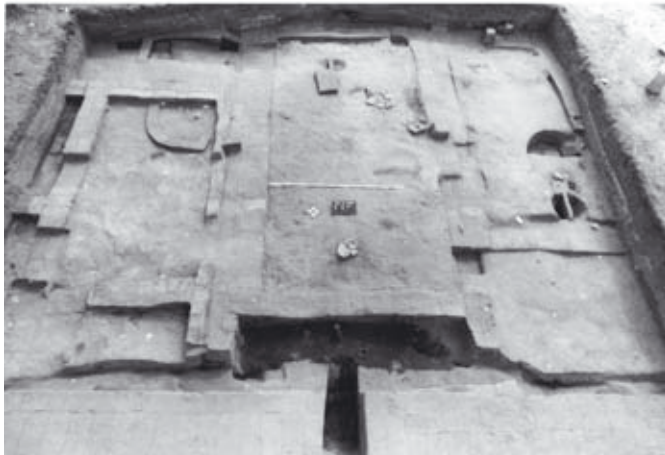

e) R/I-o/59, Pl. 2, str. c/1.2 (c/b)  
(von W)



f) R/I-o/59, Pl. 1, str. c/b und b (von W)



g) R/I-o/59, Pl. 2:  
Keramiksammlung in L105



h) R/I-o/59, Pl. 2:  
Keramiksammlung in L107





a) R/I-j/61, Pl. 1, str. d und c (von S)



b) R/I-k/60, Pl. 2, str. d und e/1 (von N)



c) R/I-k/58,k Pl. 8, str. d (L.231), str. e/1 und im Schnitt sichtbar M1 (str. e/4)



d) R/I-k/61, Pl. 2, str. d und c (von O)



e) R/I-l/61, Pl. 1, str. d und c (von N)



f) R/I-l/62, Pl. 3, str. d und c (von S)





a) R/I-m/58, Pl. 3, str. c, d, e/1 (von N)



b) R/I-m/62, Pl. 3, str. d und c, darunter e/1 sichtbar (von N)



c) R/I-n/58, Pl. 2, str. c, d, e/1 (von W)



d) R/I-m/57, Pl. 1, str. b/1.1 (von N)



e) R/I-m/57, Pl. 2, str. b/1.2 (von N). Vorne rechts 2 Scherbengruben



f) R/I-m/57, Pl. 4, str. e/1-2 (?) (von N)



R/I-n-o/57-58, Pl. 3, M191, str. e-c (?) (von N)



R/I-n-o/57-58, Pl. 1, M621 und M622, str. b (von N)





a) R/I-j-k/58, Pl. 1, L31, str. b/1 (von N)



b) R/I, j-k/58, Pl. 2, L32, 34, str. b



c) R/I-k/58, Pl. 4, L31, str. c

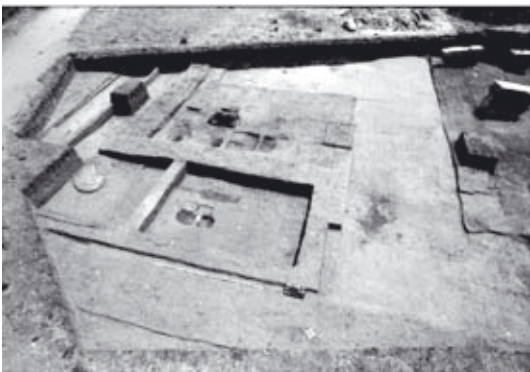

d) R/I-k/58, Pl. 4, L30, 31, 32, 34, str. c (von W)

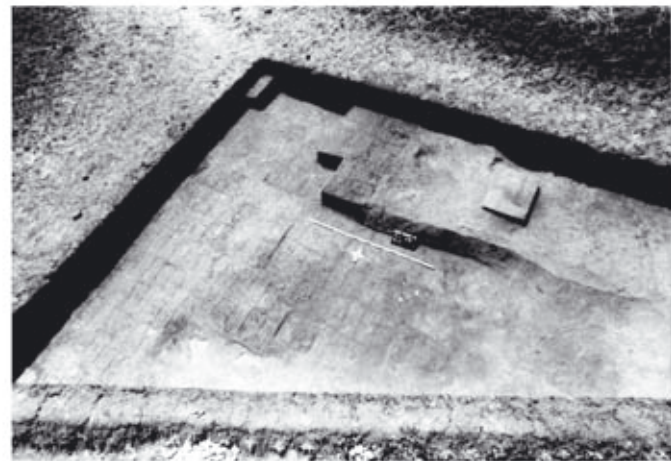

f) R/I-k/59, Pl. 2, L32 (str. c-b) mit dem darunterliegenden Pflaster L33 (str. c) (von O)



e) R/I-k/58, Pl. 5, Pflaster L30 und L33 nach Entfernen des Hofes L32 (von O)



g) R/I-k/58, Pl. 5, L31, ältere Mauern (von N)



h) R/I-k/58-59, Pl. 6, L31, 34, Mauerfundamente, str. c



i) R/I-k/58, Pl. 7, Fundamentgräben





a) R/I-k/60, Pl. 1, str. c, Bauvorgangsrelikte, L90, L99, Rinne (von N)



b) R/I-k/59, Pl. 1, str. c, L131, L99, Rinne (von N)



c) R/I-k/61, Pl. 1, str. c. Tempelumfassungsmauer U1, und Mauerstümpfe M615-M619 (str. c/1) (von O)



d) Blick vom Tempelvorhof (von Norden) auf das Tempelhaus mit dem Peristylhof L25 und den lateralen Einbauten L26-29, dahinter der Sanktuartrakt





a) Der Eingang zum Tempelhaus mit dem Schwellenfundament L605 (von N)



d) R/I-I/59, Pl. 2, L29, str. c (von W)



b) Der Peristylhof mit lateralen Einbauten (L25-L29), Ansicht von W. Im Vordergrund: L28 und L29



e) R/I-I/59, Pl. 2, L25 mit Becken und Rinnen-Unterlagsblöcken



c) R/I-I/60, Pl. 2, der Peristylhof L25 (von O)



f) R/I-I/60, Pl. 1, L26, 27 (von N)



g) R/I-I/59, Pl. 1 (nach Entfernung der Rinne), Schwelle L604, Säulen 1-3

Tafel 227 Der Peristylhof mit den lateralen Einbauten L25 – 29; die Schwellen L604, L605



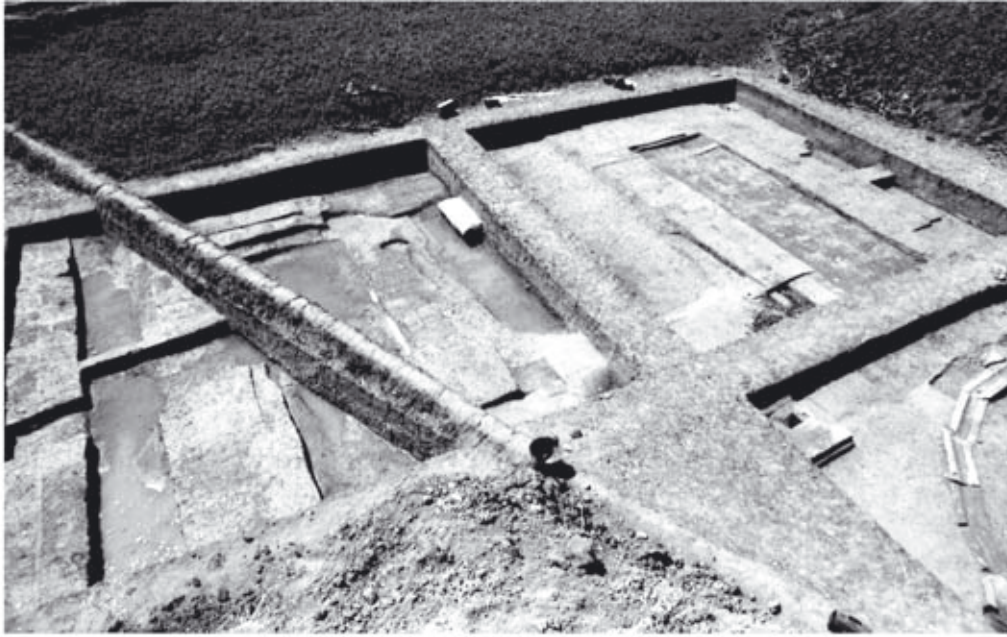

a) R/I-m/59-60, Pl. 1, die 3 Sanktuare L20, 21, 22 (von N)



b) R/I-m/59-60, die Sanktuare nach Abtiefung in den Fundamentbereich (von SO)



c) Das West- und Mittelsanktuar (L21, L20) von S. Das Pflaster von L21 ist noch in situ



d) L21 und L20 nach Abtiefung in den Fundamentbereich mit Mauerkronen str. e/1 in L21 (von SW)



e) R/I-m/58, Pl. 1 mit dem gepflasterten Tempelgang L37, der Tempelumfassungsmauer U3, der Gasse L79 und der Umfassungsmauer M191. Rechts Plq. m/57 (von N)





Das SW-Eck des Tempels  
im Fundamentbereich



R/I-n/59, Pl. 1, die Rückwand des  
Sanktuartraktes M688, die Rückwand  
des Tempelhauses N2, der gepflasterte  
Umgang L36, und die Tempelumfassungsmauer  
U2 (von W)



R/I-n/60, Pl. 2, Rückwand N2, L36, U2, die Gasse L77  
und M533 (str. c) (von W)



R/I-n/60, Pl. 1, N2, L36, und die jüngere Gasse L78, str. b (von S)



R/I-n/61, Pl. 3, Pflaster L35/36, erneuerte Umfassungsmauer  
U1 (str. c/1), Umfassungsmauer U2 (von W)

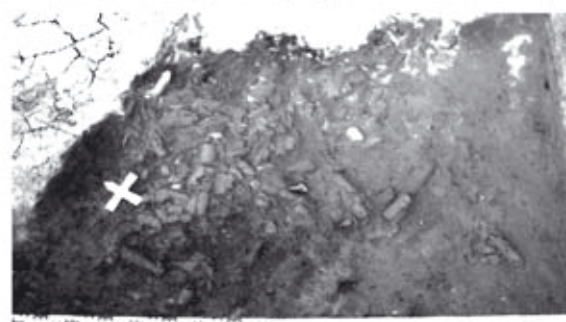

R/I-n/61, Pl. 1, L517, str. b/1





a) R/I-k/61, Pl. 1, str. c. Tempelumfassungsmauer U1, und Mauerstümpfe M615-M619 (str. c/1) (von O)



b) R/I-l/61, Pl. 1 (von O). Tempelhaus N1, Umgang L35, Umfassungsmauer U1, M 609 - M612 (str. c/1)



c) R/I-l/62, Pl. 1, str. c und b mit Grube 3 (str. a-b). Links hinten Mauer str. a (von W)



d) R/I-m/61, Pl. 1, str. c und b (darunter c/1) (von N)



e) R/I-m/62, Pl. 2, str. c (von W)



f) R/I-m/62, Pl. 1, str. b (von W)

Tafel 230 Das sog. Wirtschaftsgebäude (nördlicher Teil)





a) R/I-n/61, Pl. 2, der „Kornspeicher“, str. c/1



b) R/I-n/62, Pl. 1, die „Bäckerei“, str. b/1



c) R/I-n/62, Pl. 1, die „Bäckerei“, Situation 2, str. b/1

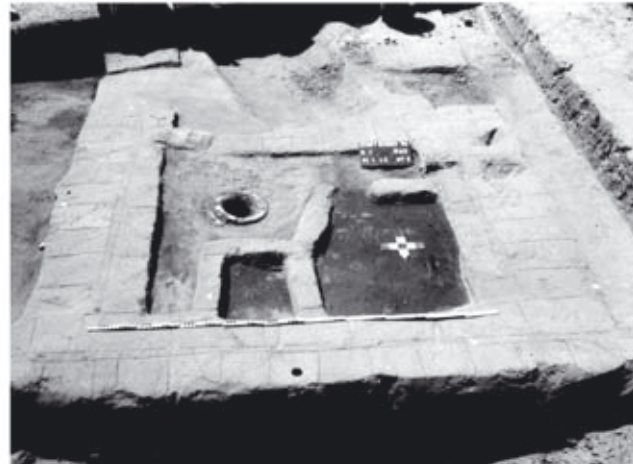

d) R/I-n/62, Pl. 1, die „Bäckerei“, Situation 3, str. b/1

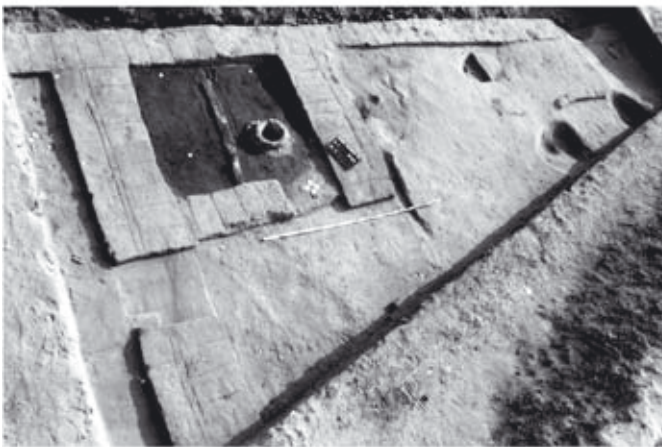

e) R/I-n/62, Pl. 2, str. b/2



f) R/I-n/62, Pl. 3, str. c/1

Tafel 231 Das sog. Wirtschaftsgebäude (südlicher Teil)

