

# **PLÄNE UND PROFILE**

Pläne 1–12 (str. a – str. f)  
Schlüssel zu den Profilen und Schnitten (1–67)  
Materialcodes  
Profile und Schnitte 1–67







str. b1.2



str. b1.1







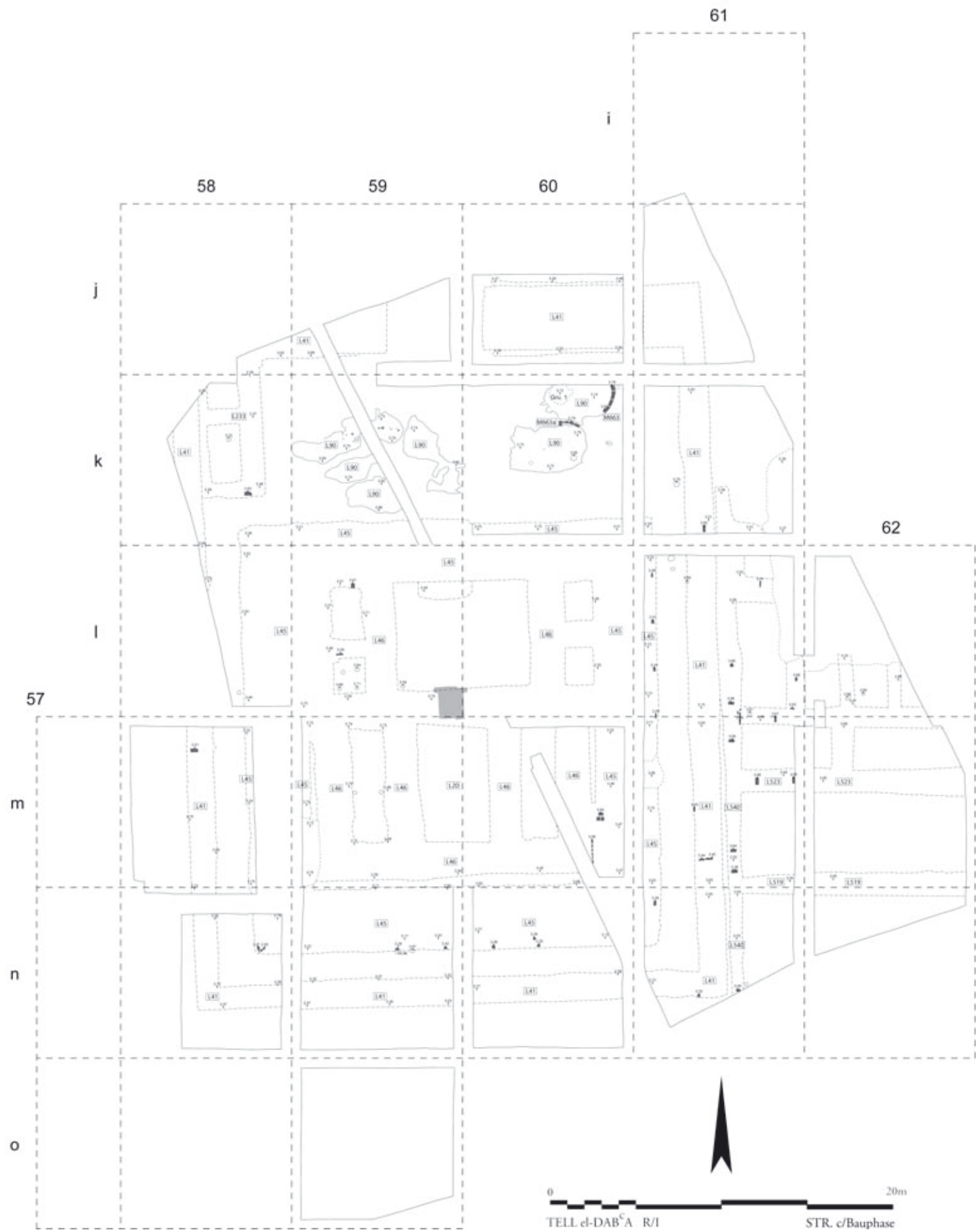





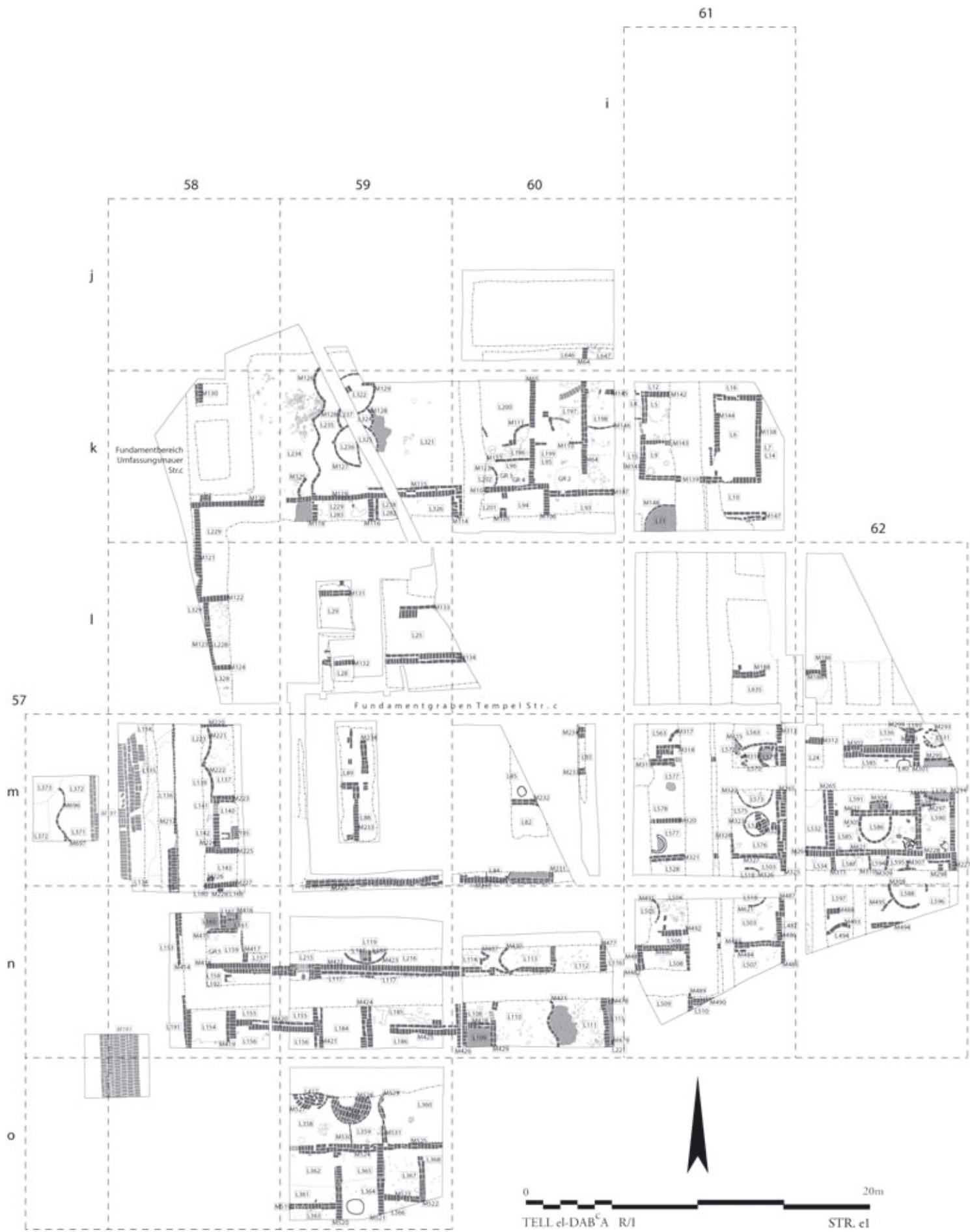





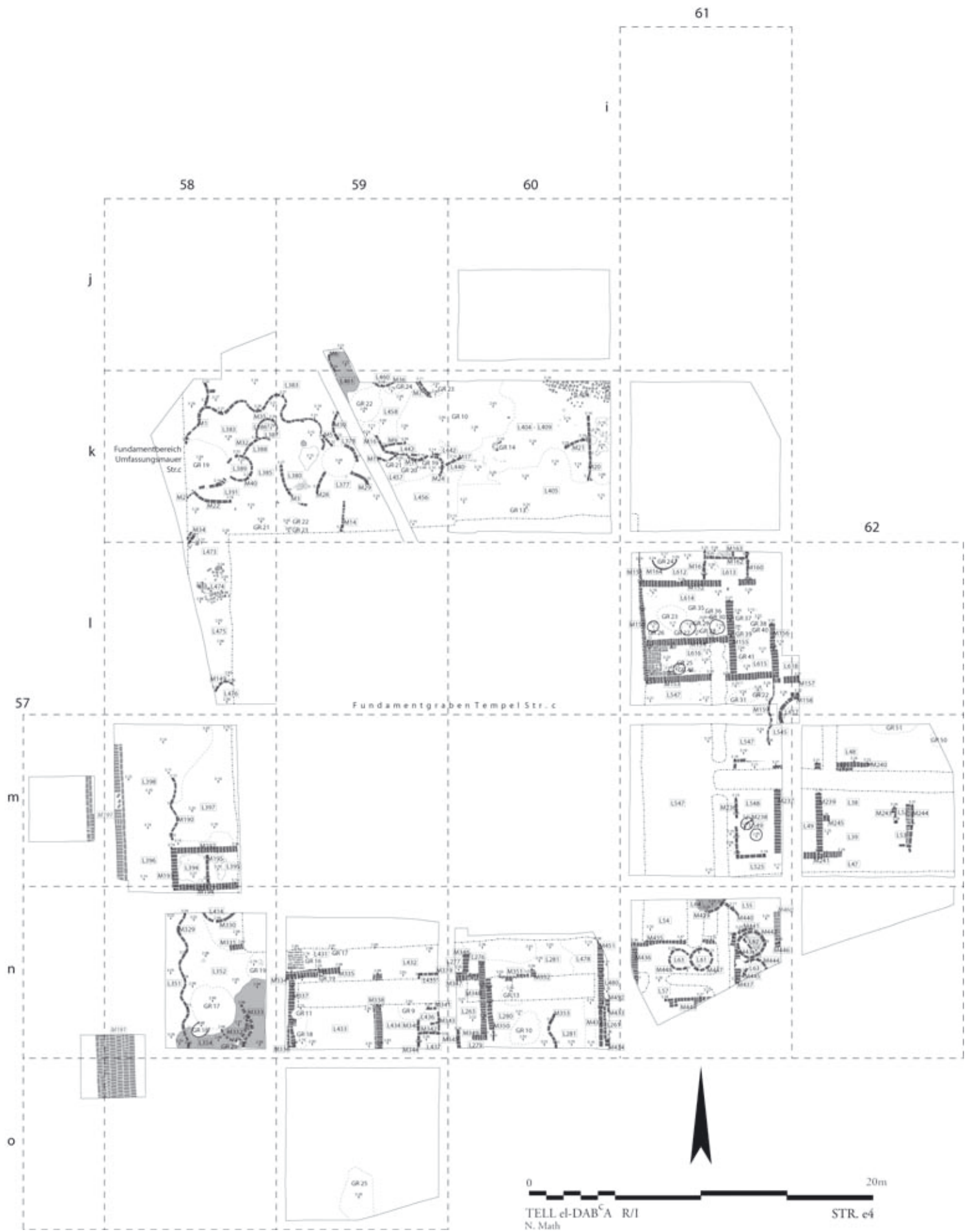











Schlüssel zu den Profilen und Schnitten (1–67)

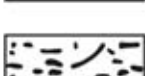

## Materialcodes

	SCHLAMMZIEGEL, -BRUCH, -VERSTURZ
	SANDZIEGEL, -BRUCH, -VERSTURZ
	KALKSTEIN
	SCHLAMMERDE
	SANDIG - HUMOSE SCHICHTEN
	SANDIGE SCHICHTEN
	REINER SAND
	GEZIRA
	LEHMESTRICH, FETTER LEHM
	VERWITTERTE LEHM - UND SCHLAMMZIEGELVERSTURZSCHICHTEN
	ASCHE SCHICHTEN
	ASCHE MIT HOLZKOHLESTÜCKCHEN, BRANDSCHICHTE
	KERAMIKSCHERBEN



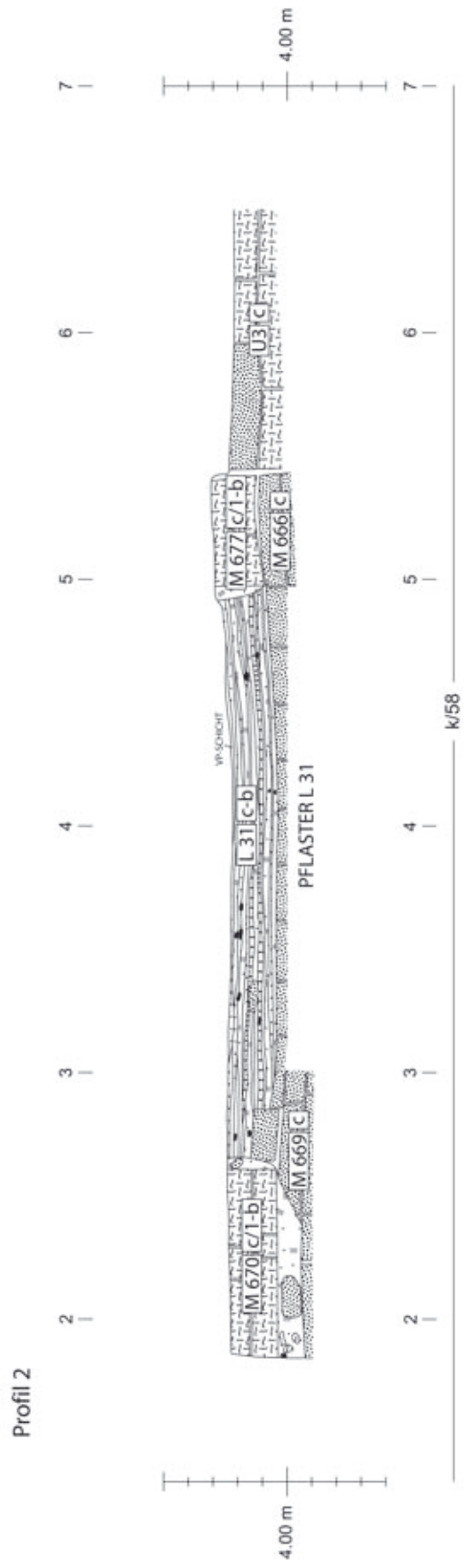
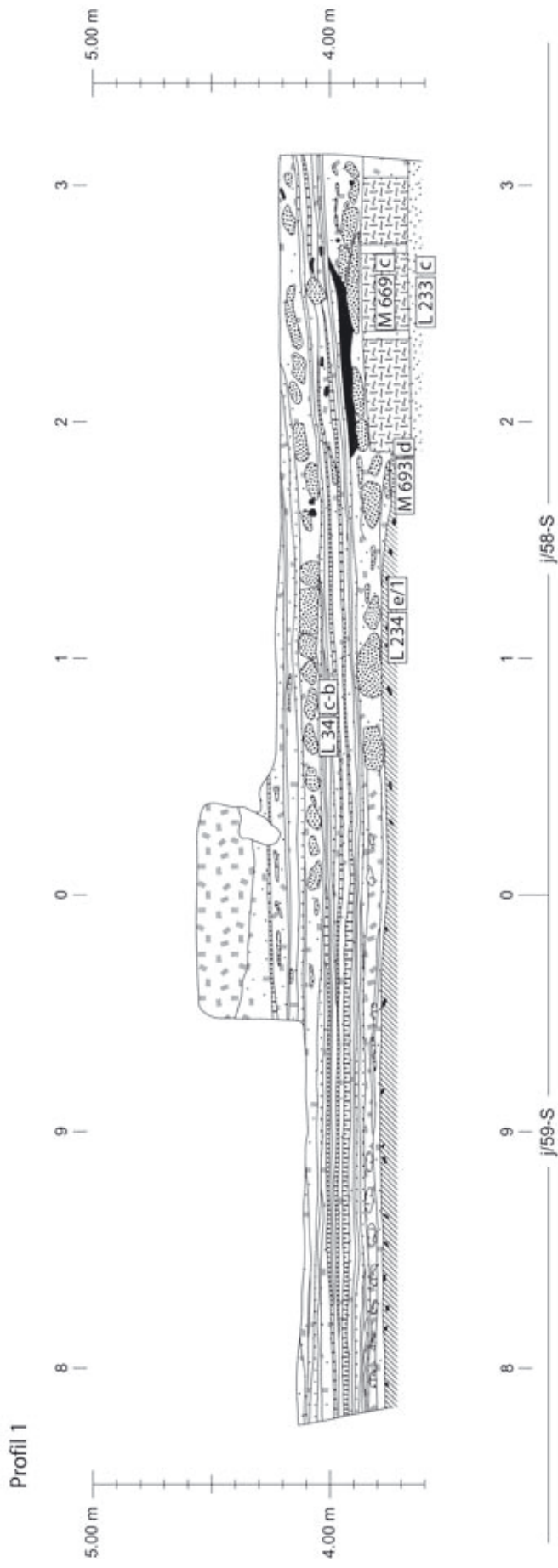

Profile 1-2

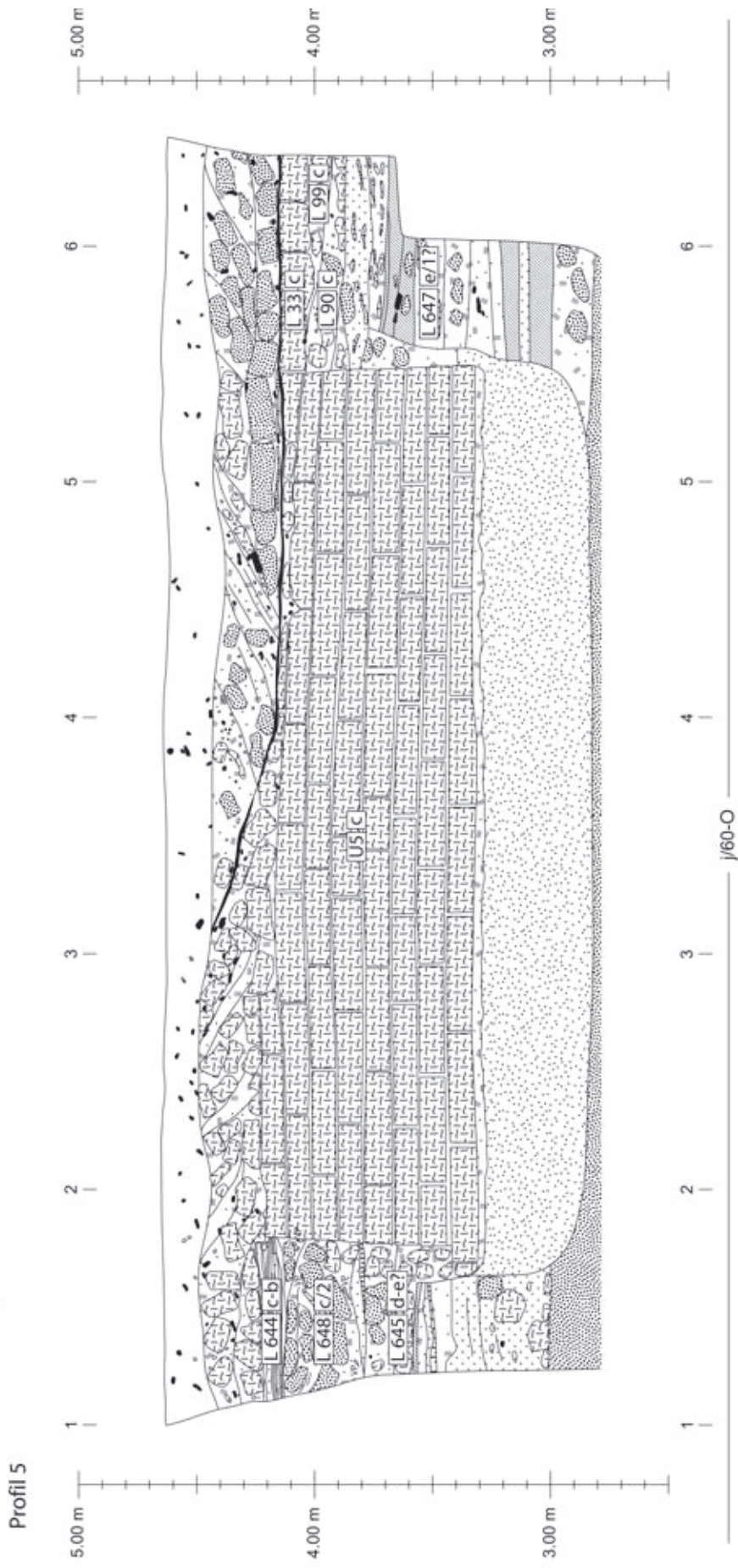
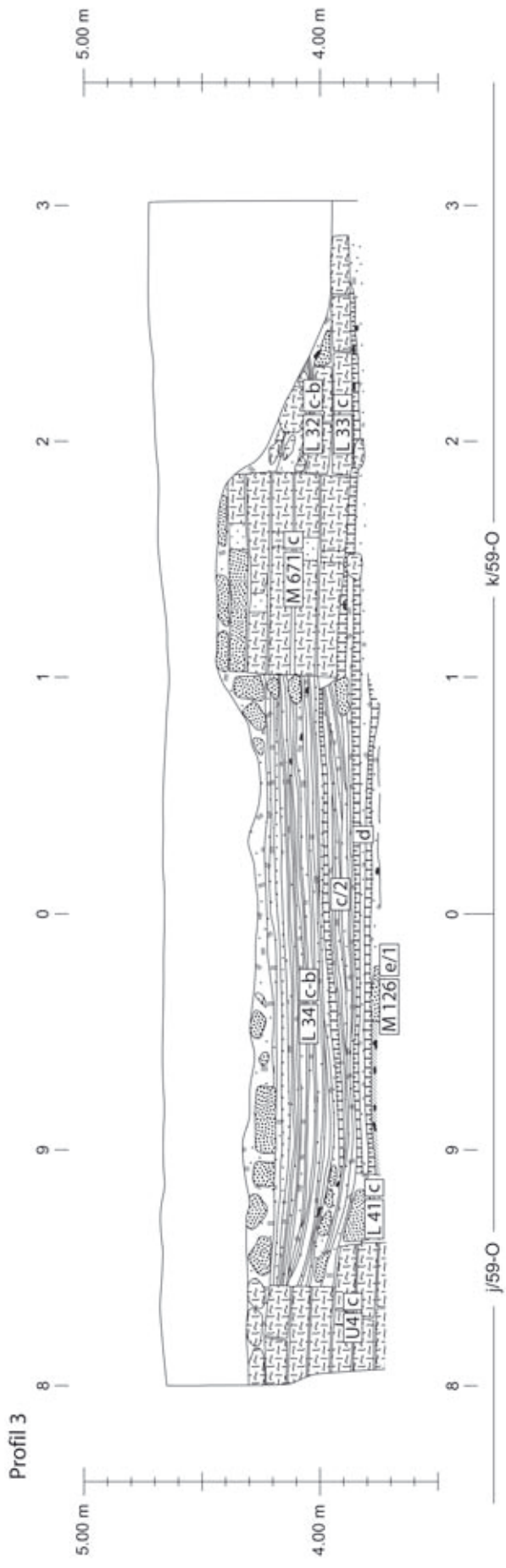

Profile 3, 5

Profil 6

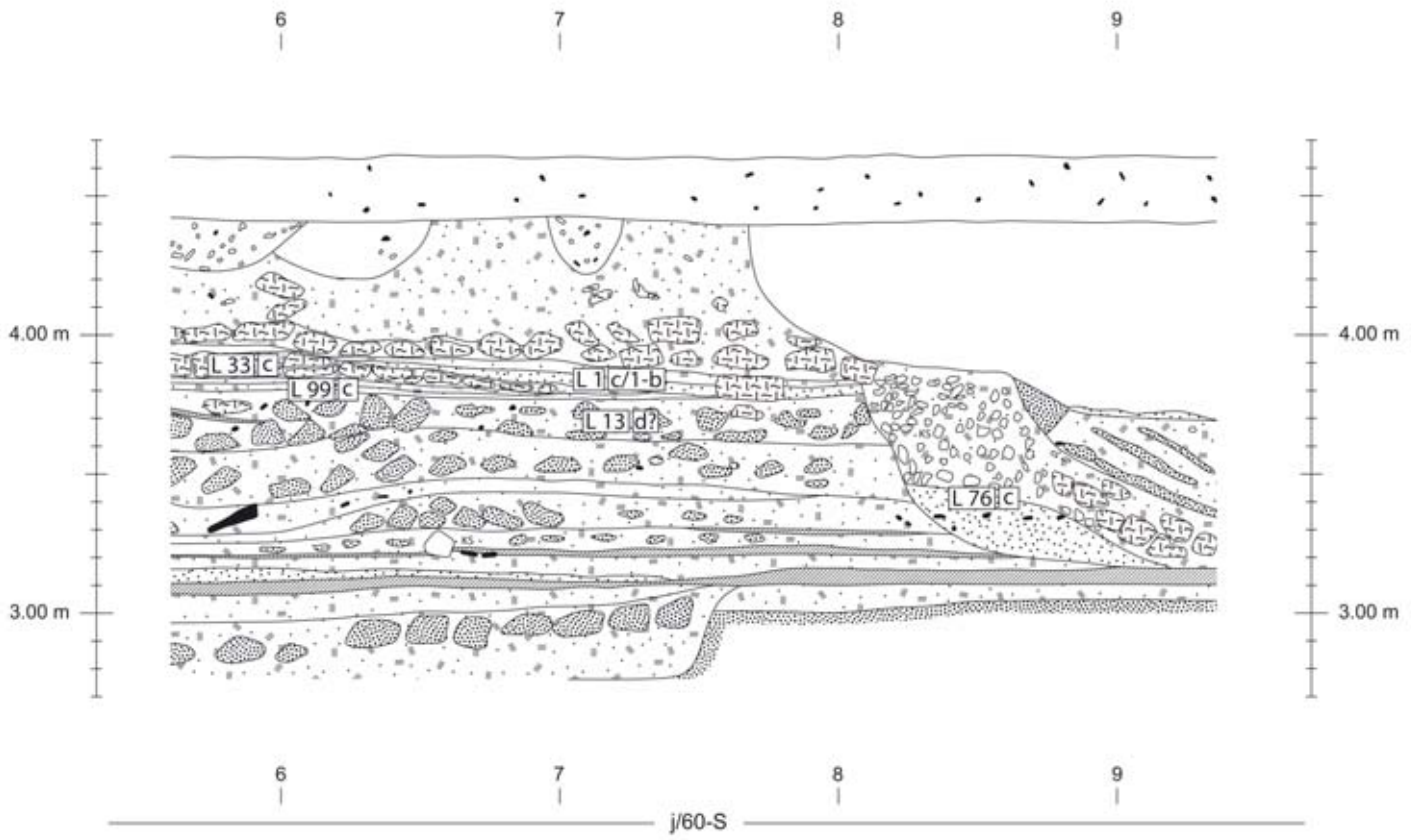

Profil 7

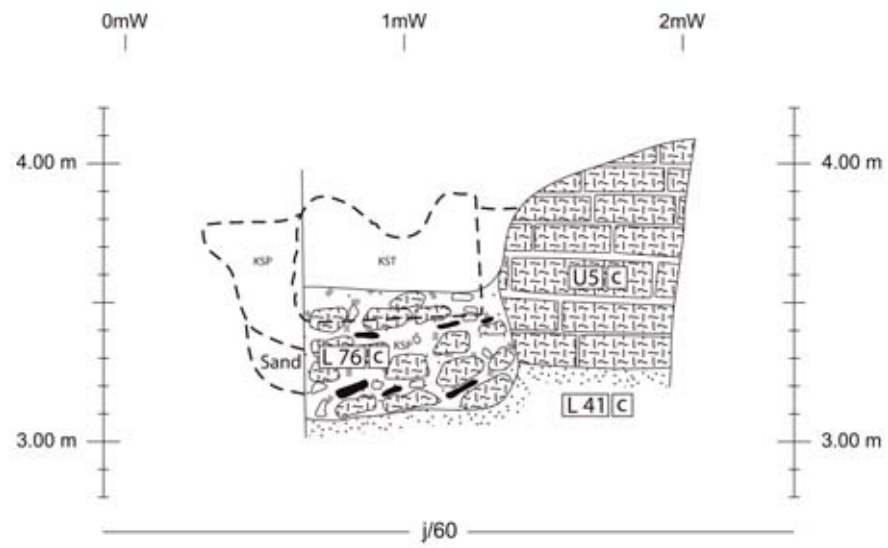

Profile 6-7

Profil 10



Profil 10

Profil 11

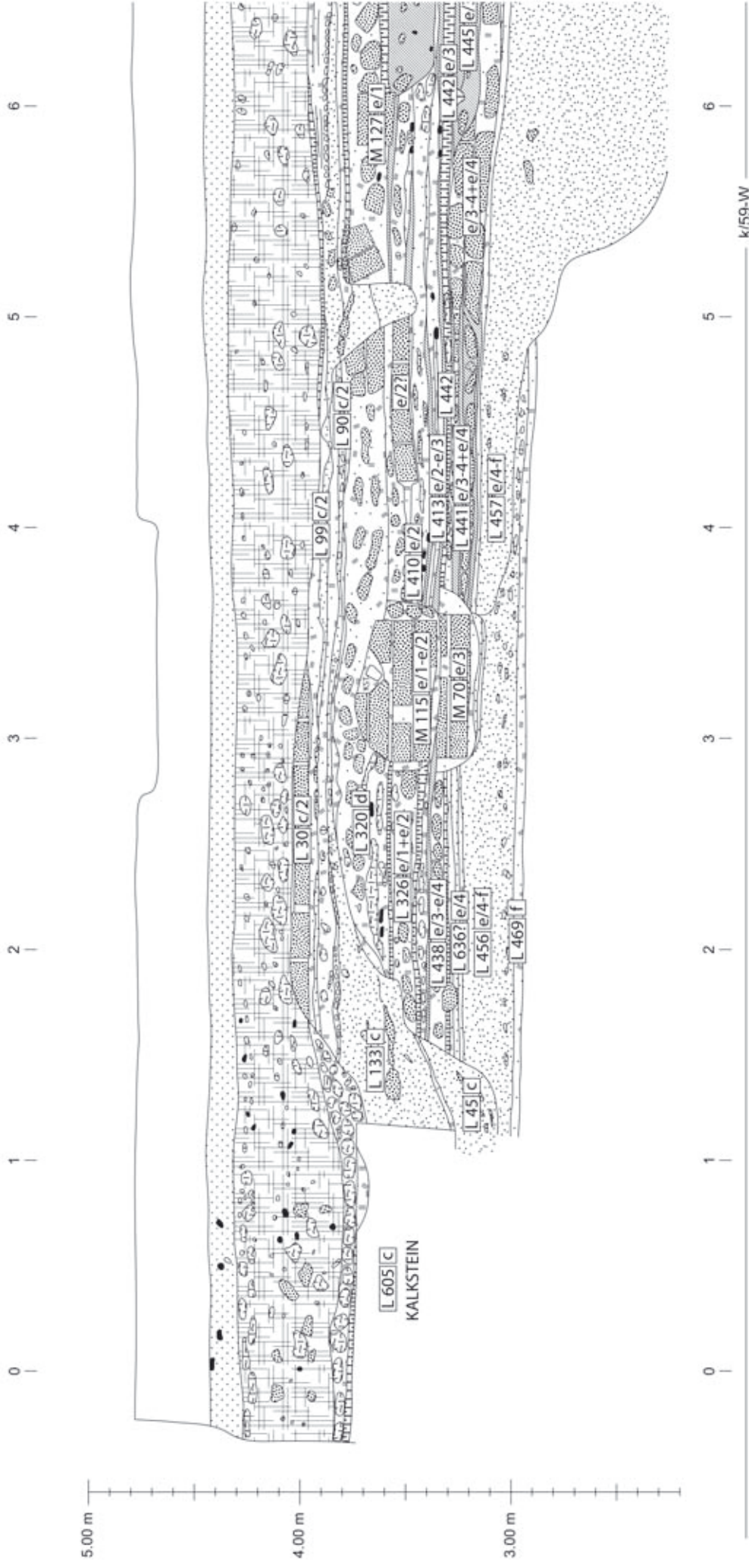

Profil 11a

Profil 11/2

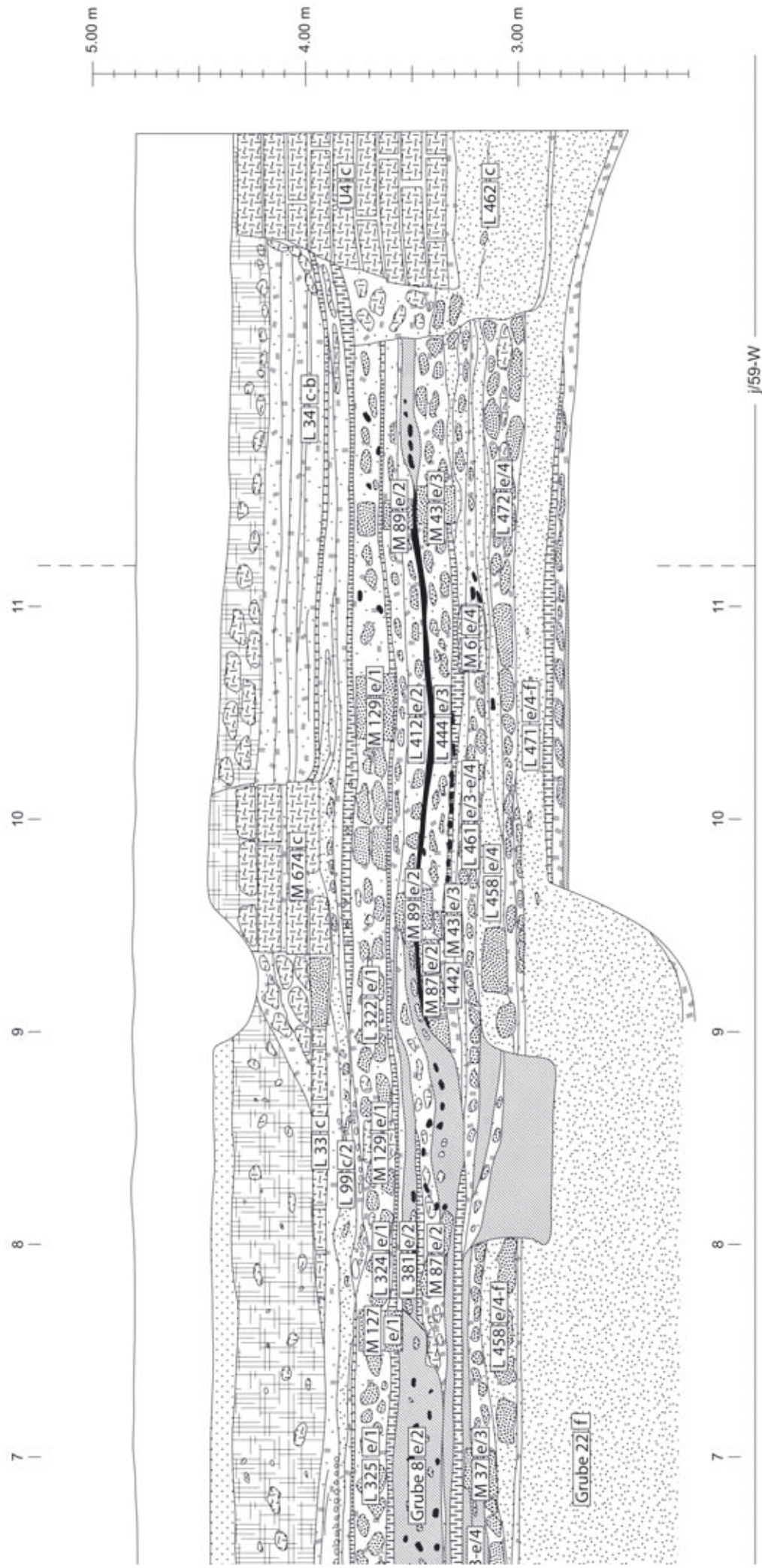

Profil 11b

Profil 12

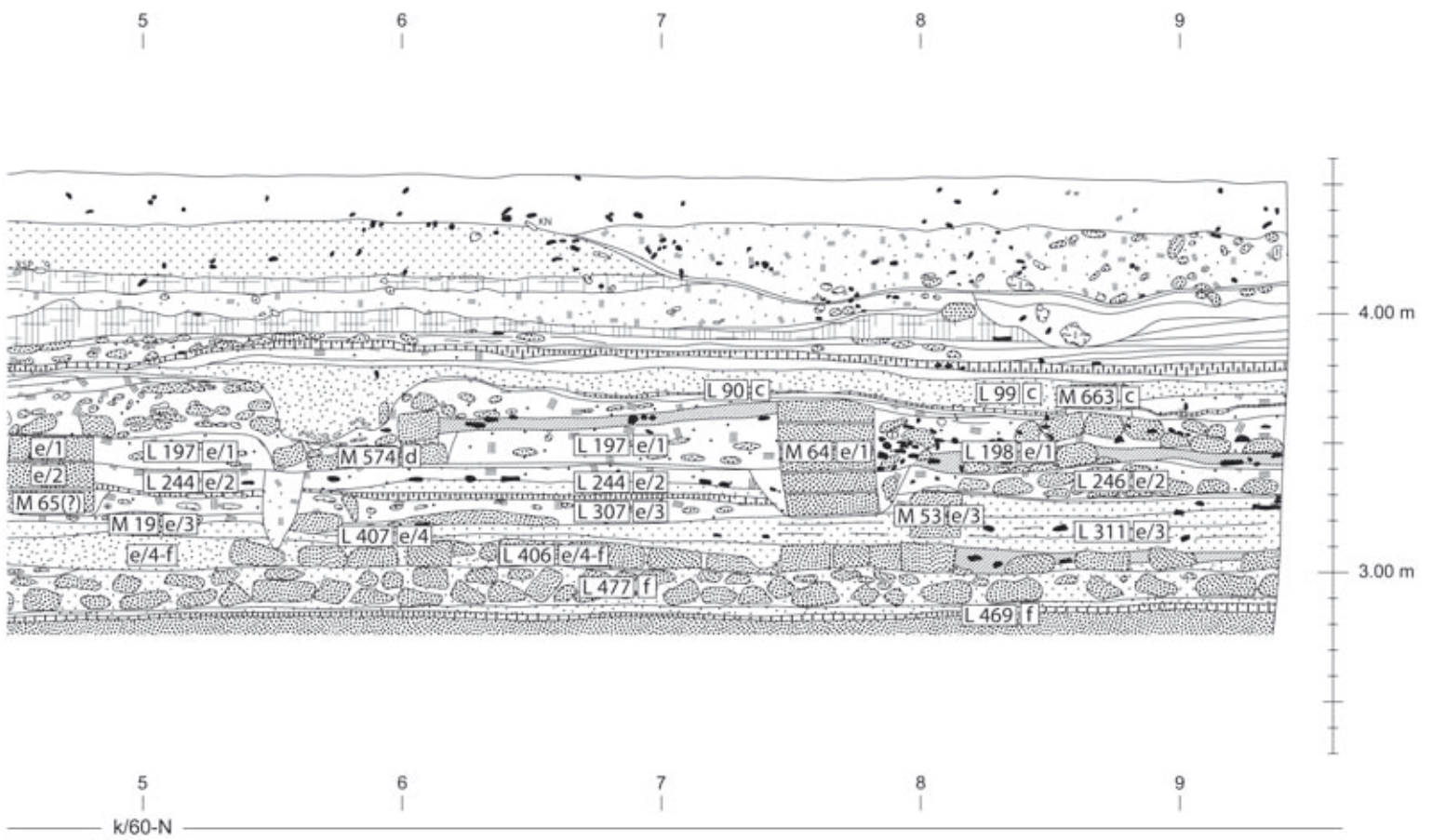
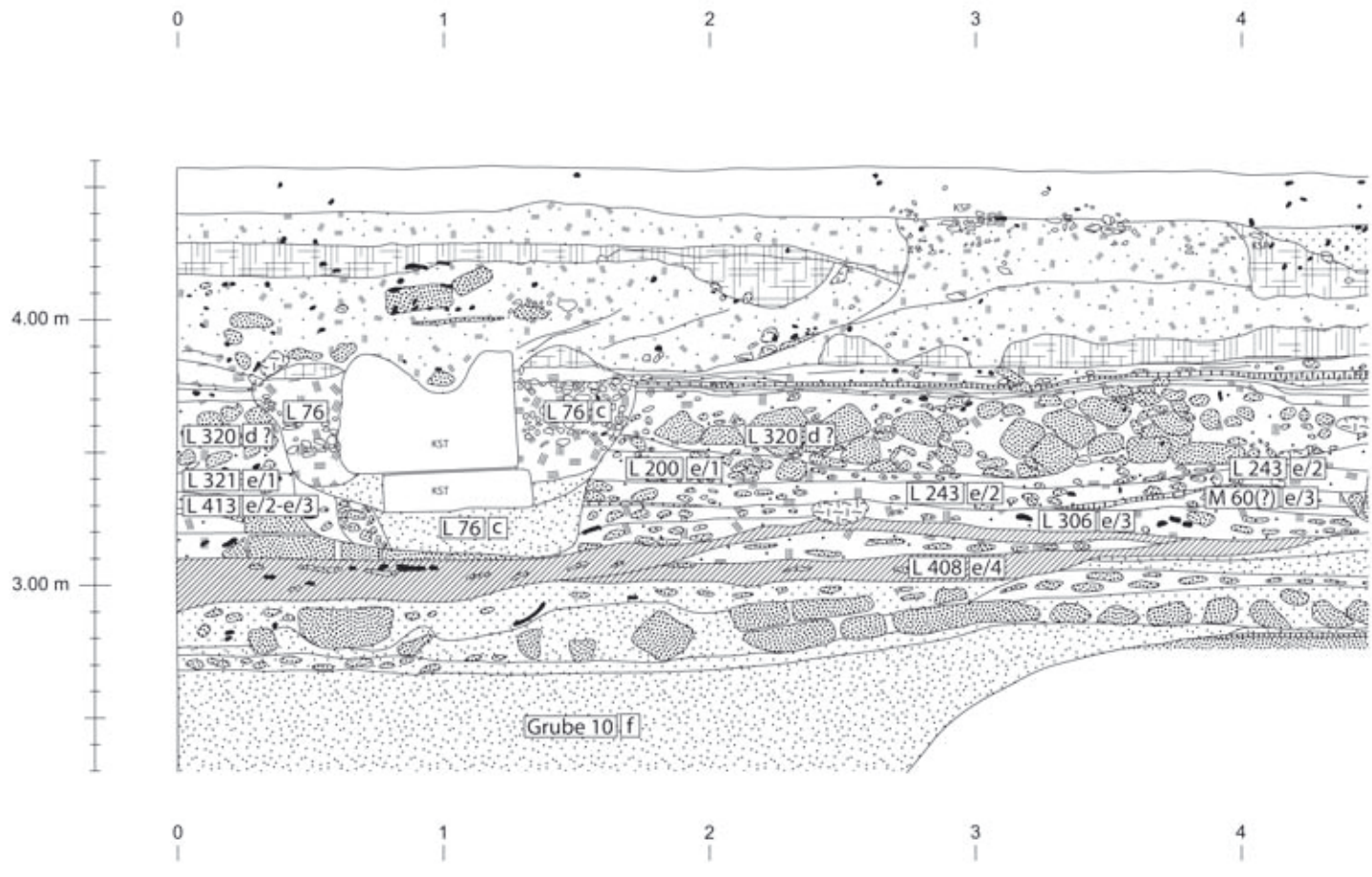

Profil 12

k/60-N

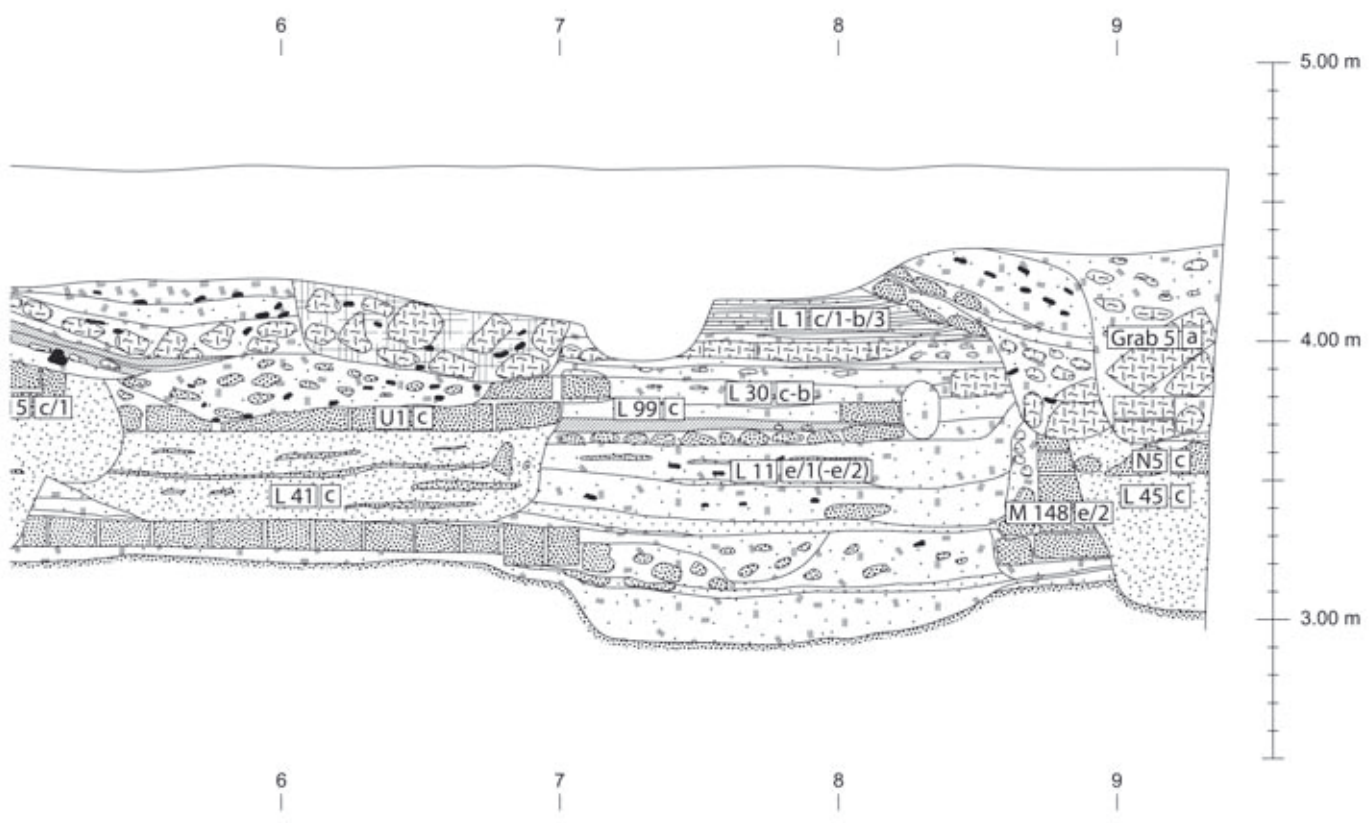
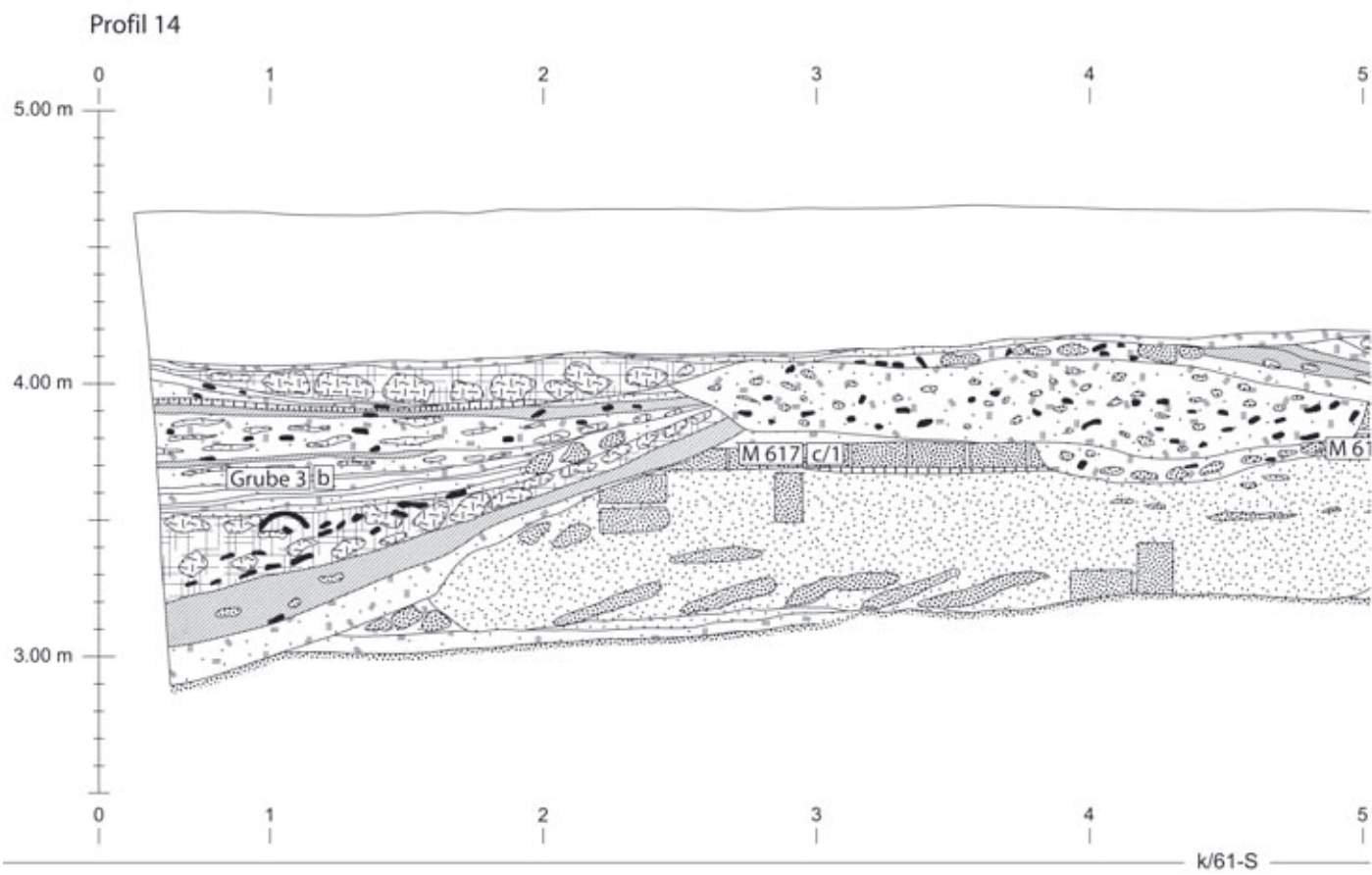

Profil 14



Profil 15

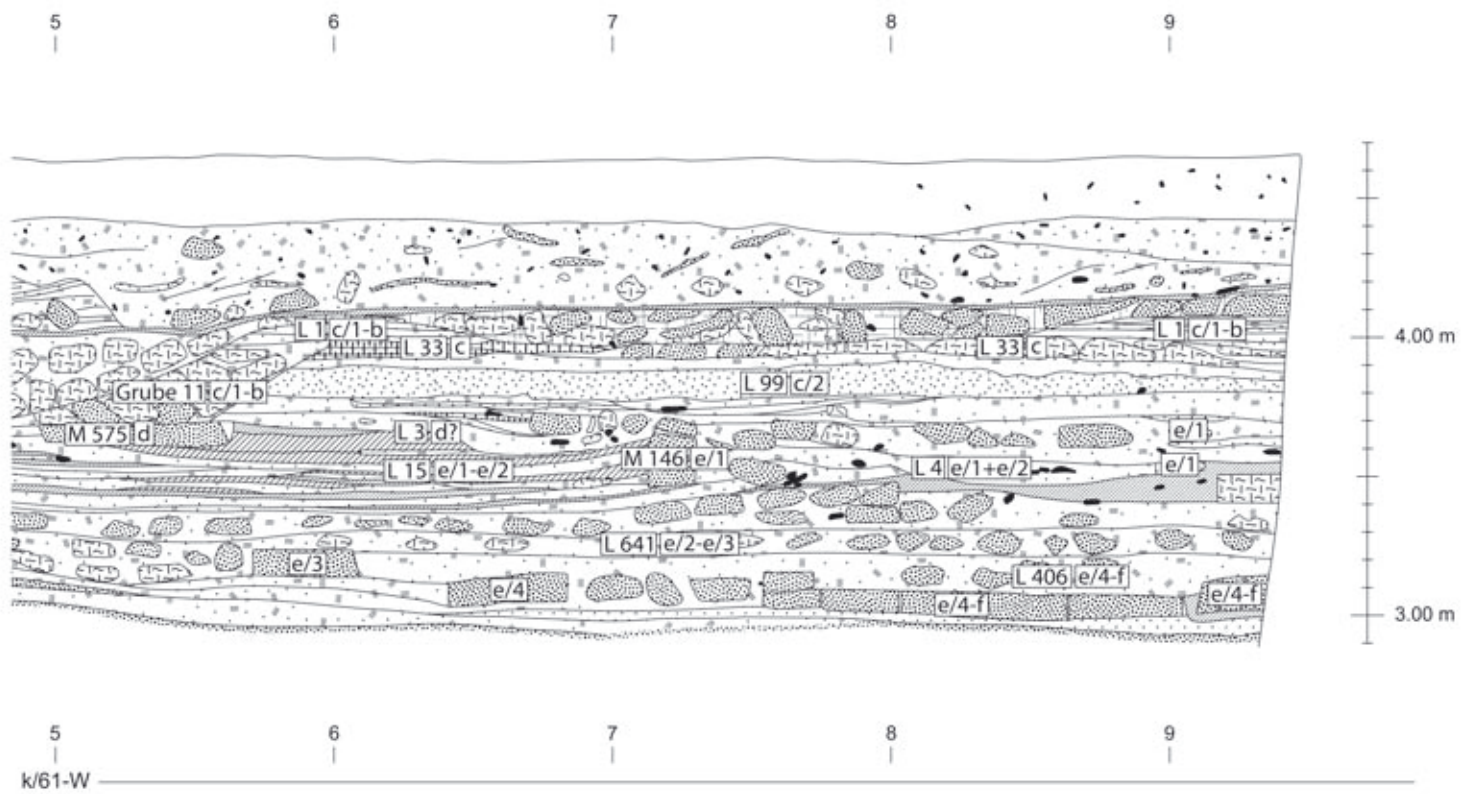
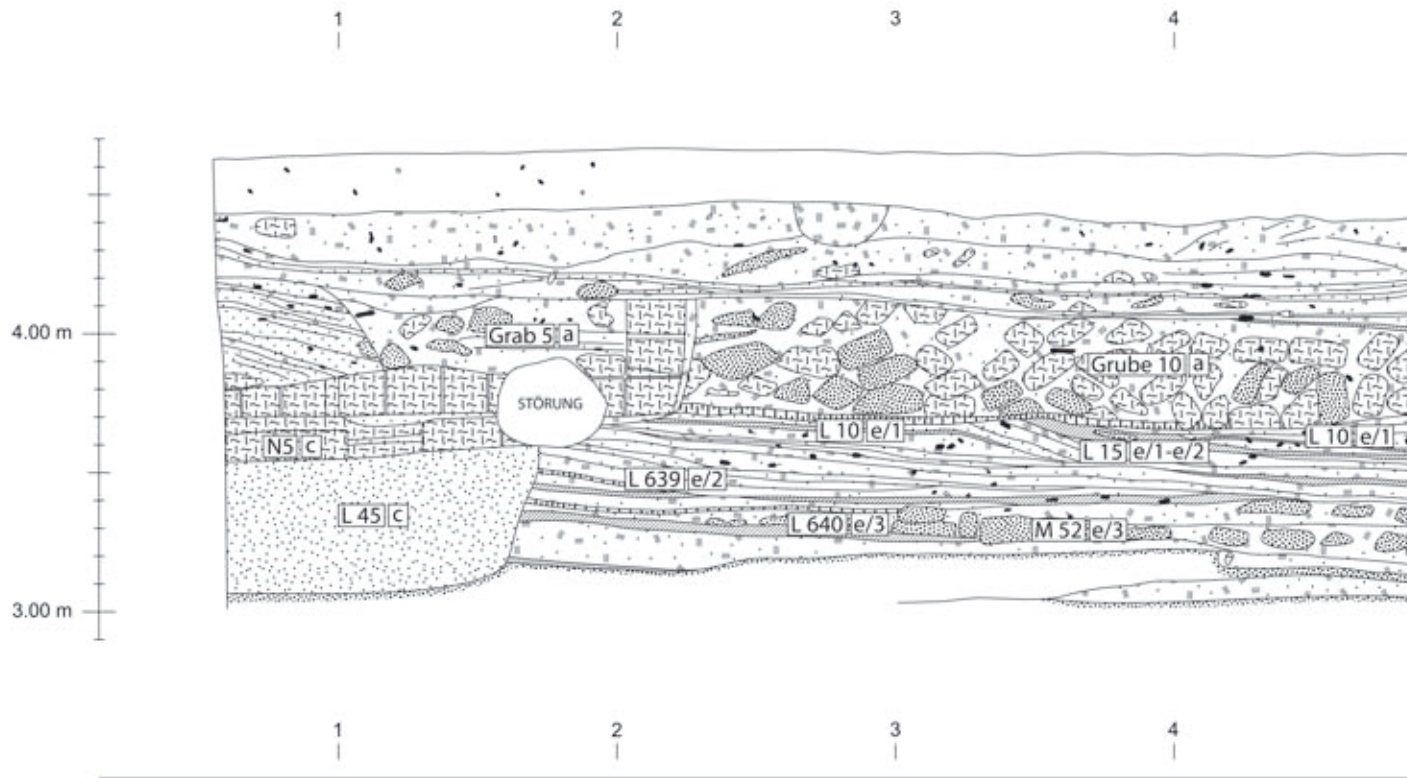

Profil 15

Profil 17

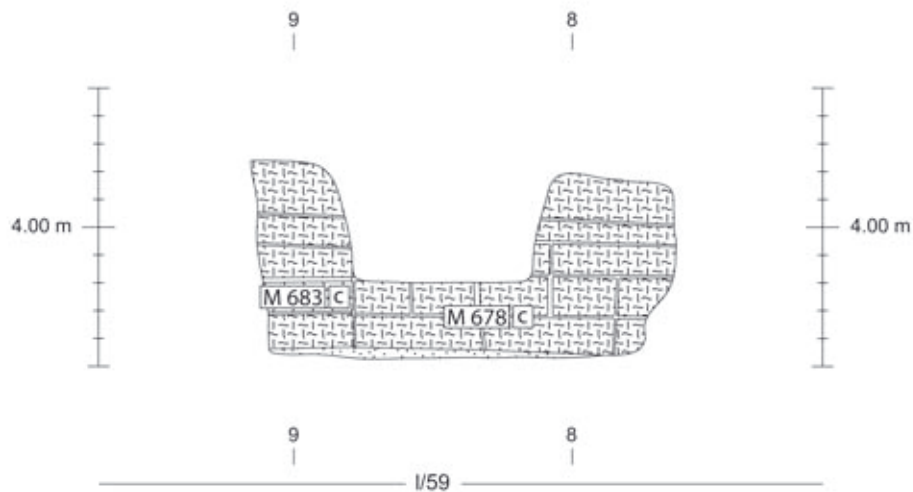

Profil 20

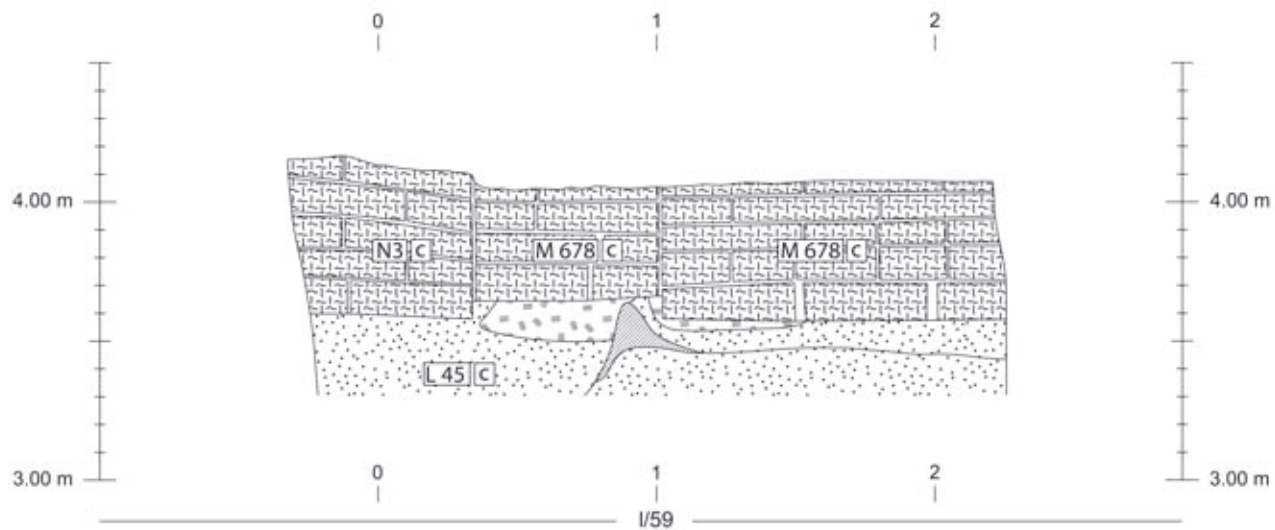

Profile 17, 20

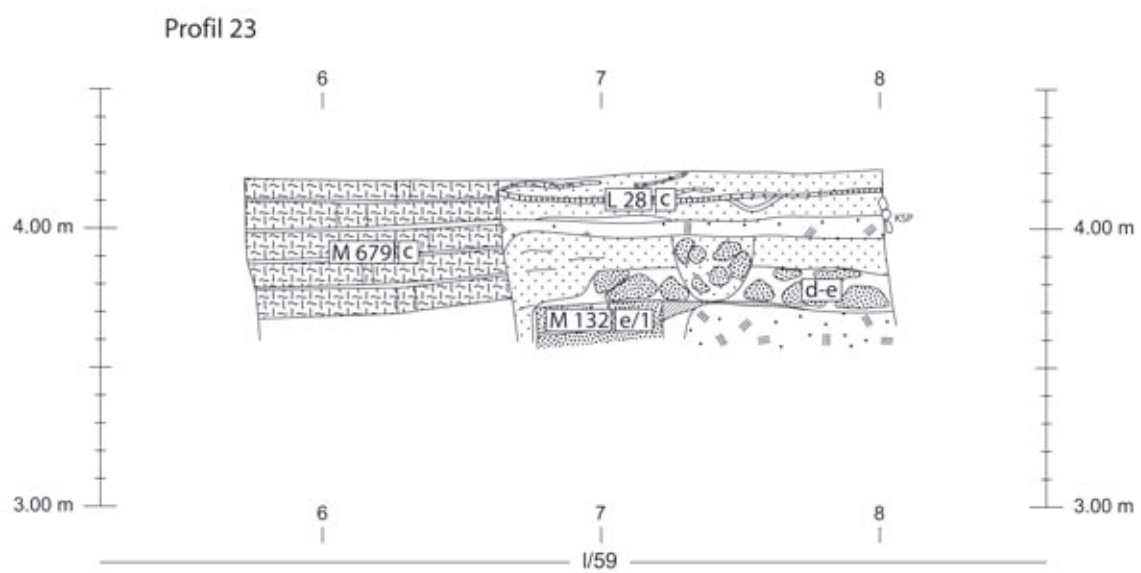
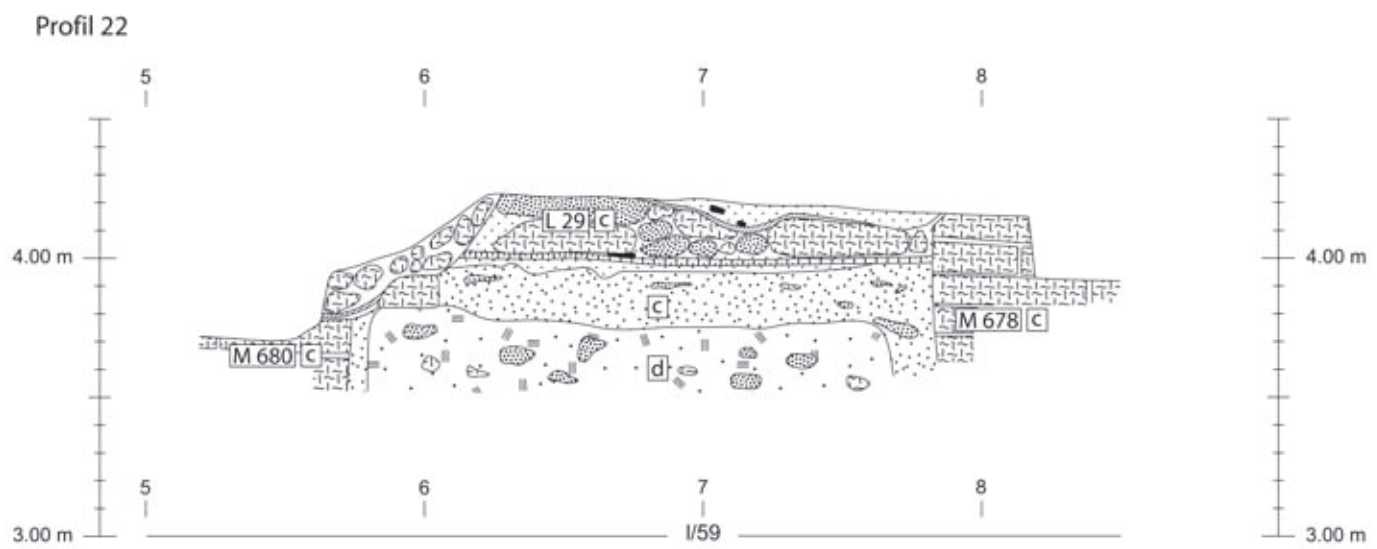
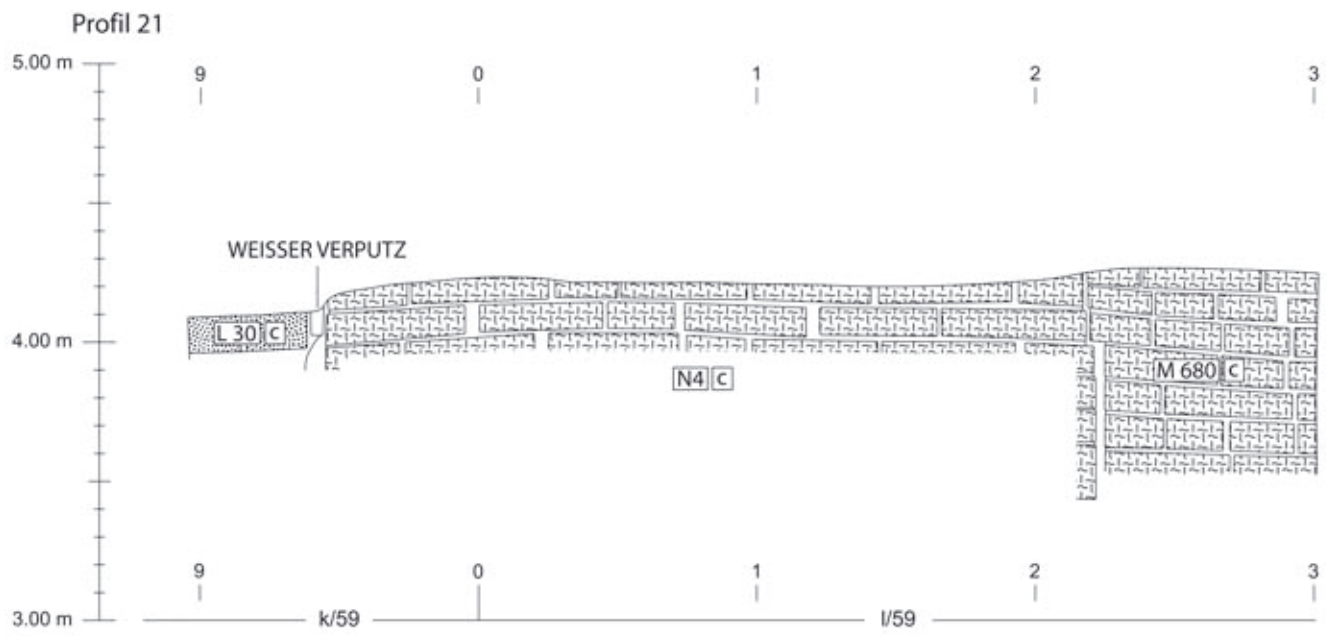

Profile 21-23

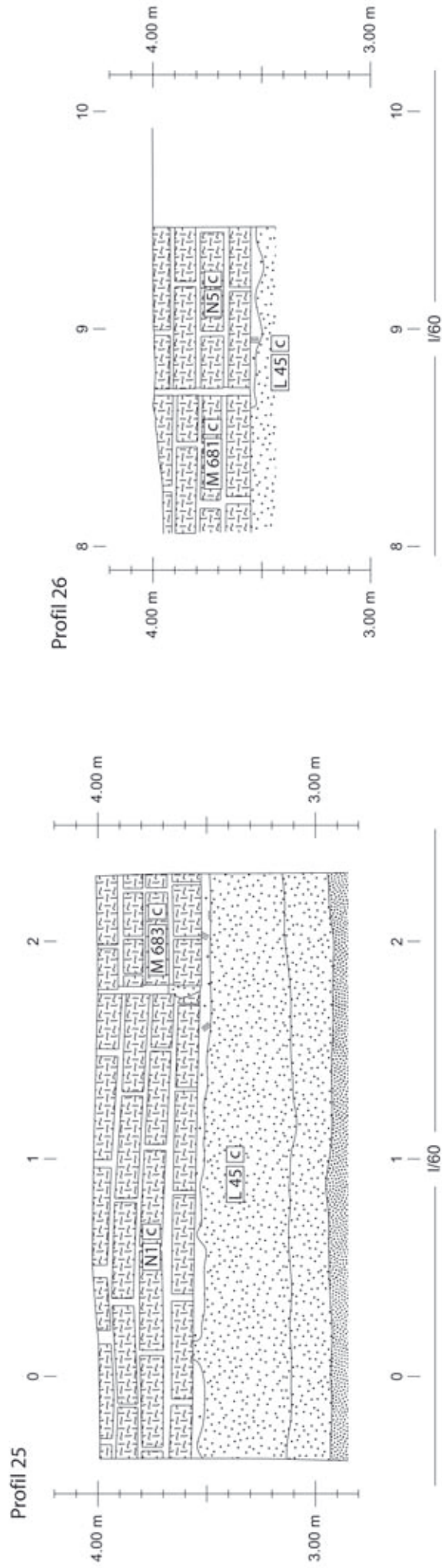
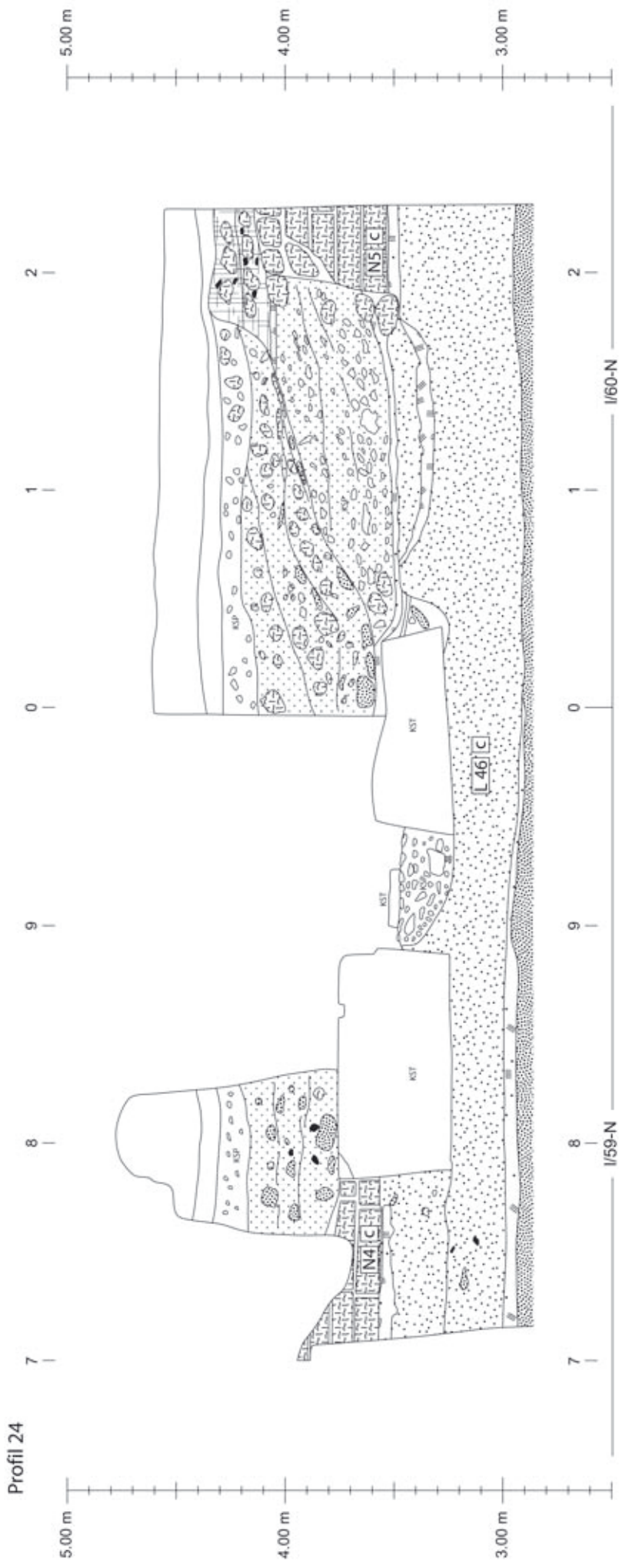

Profile 24-26

Profil 30

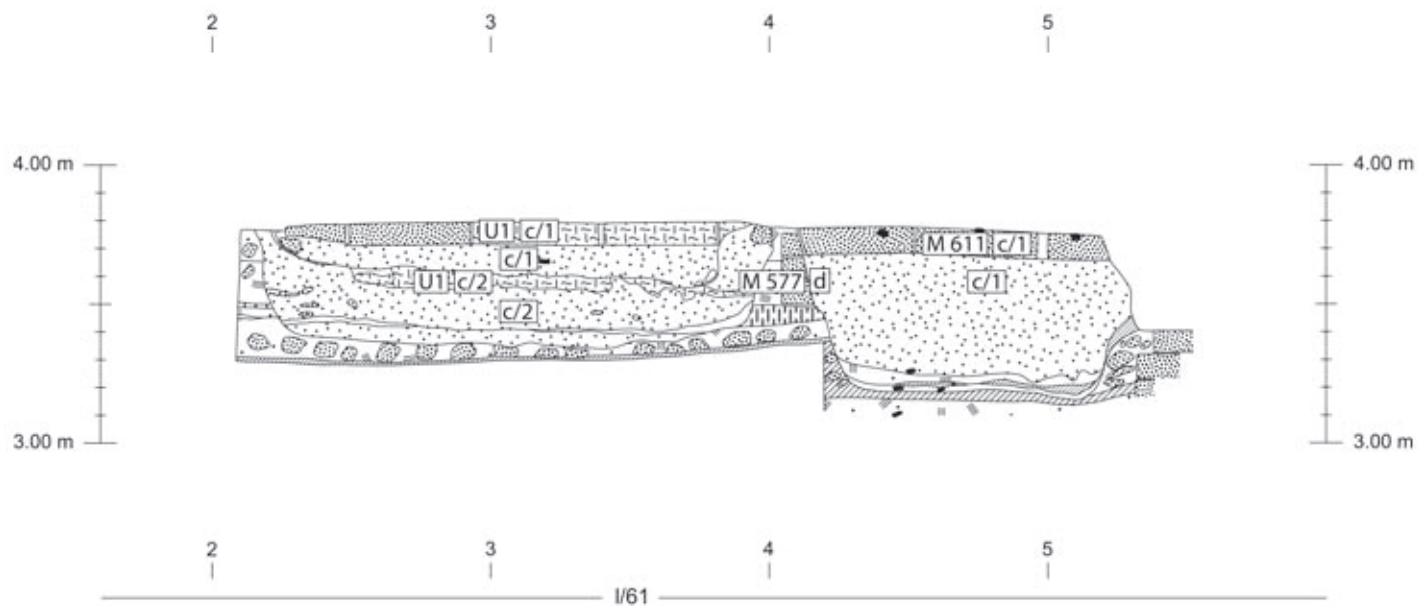

Profil 40

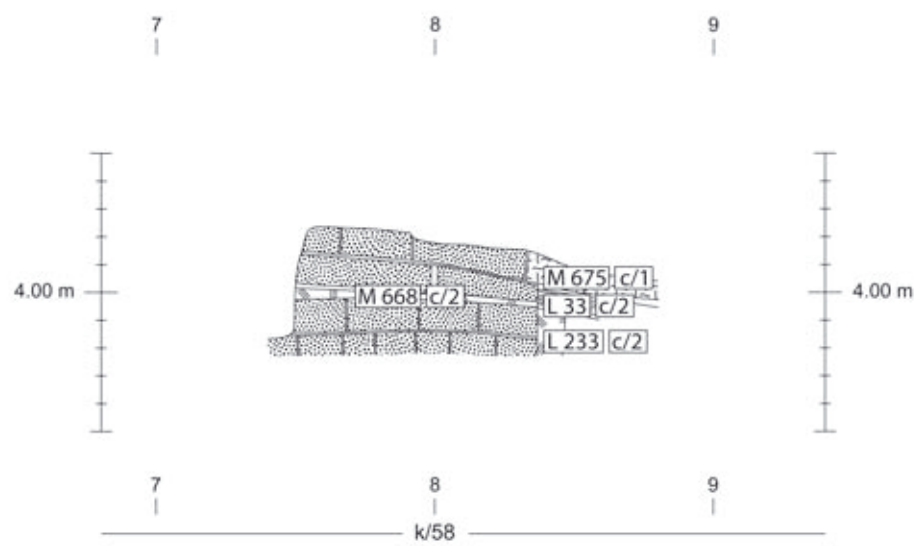

Profile 30, 40

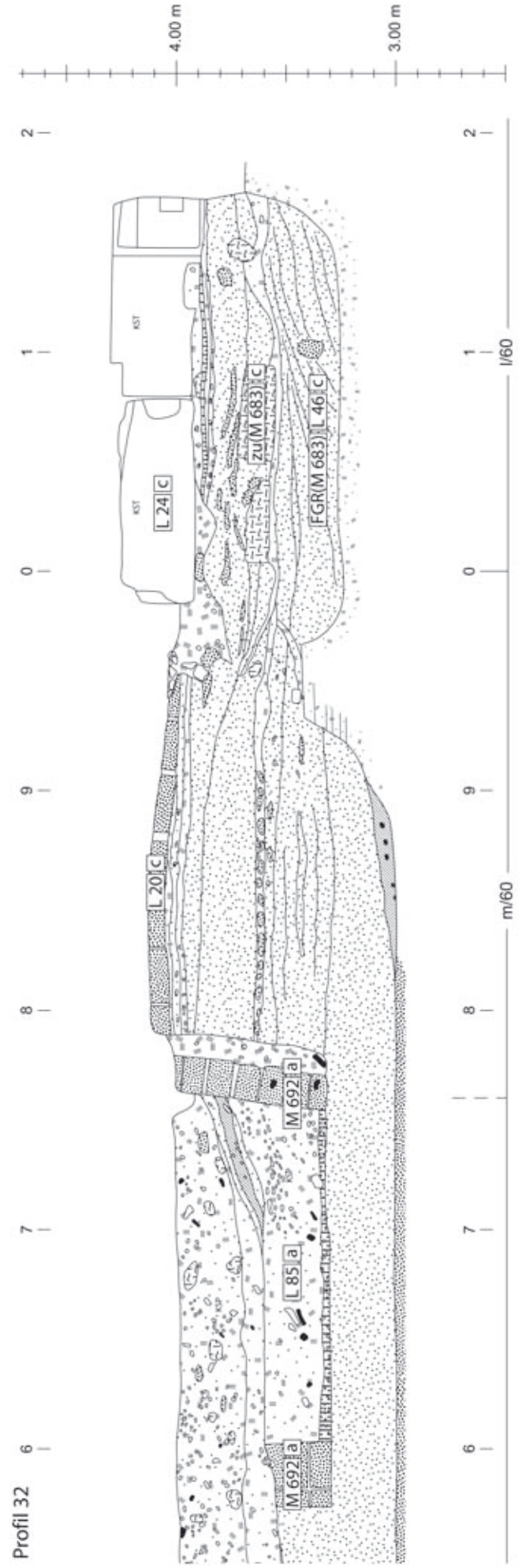
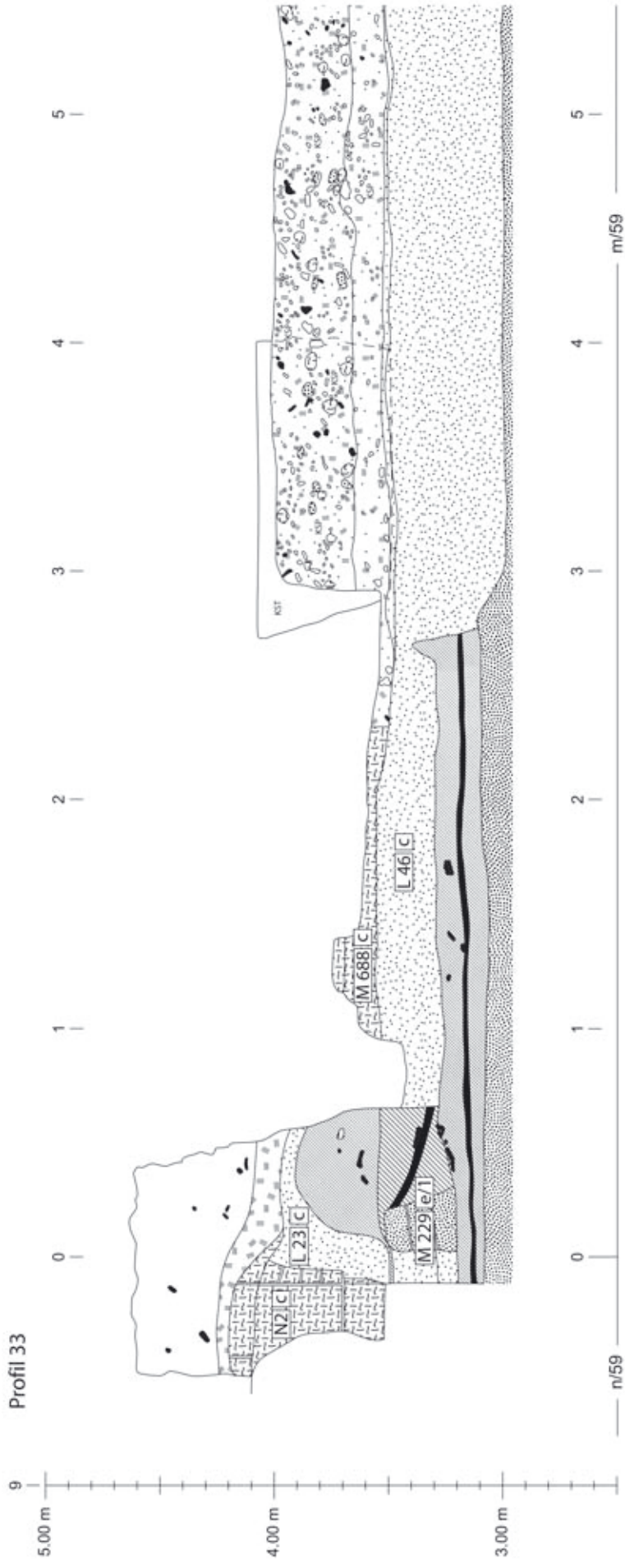

Profile 32-33

Profil 34

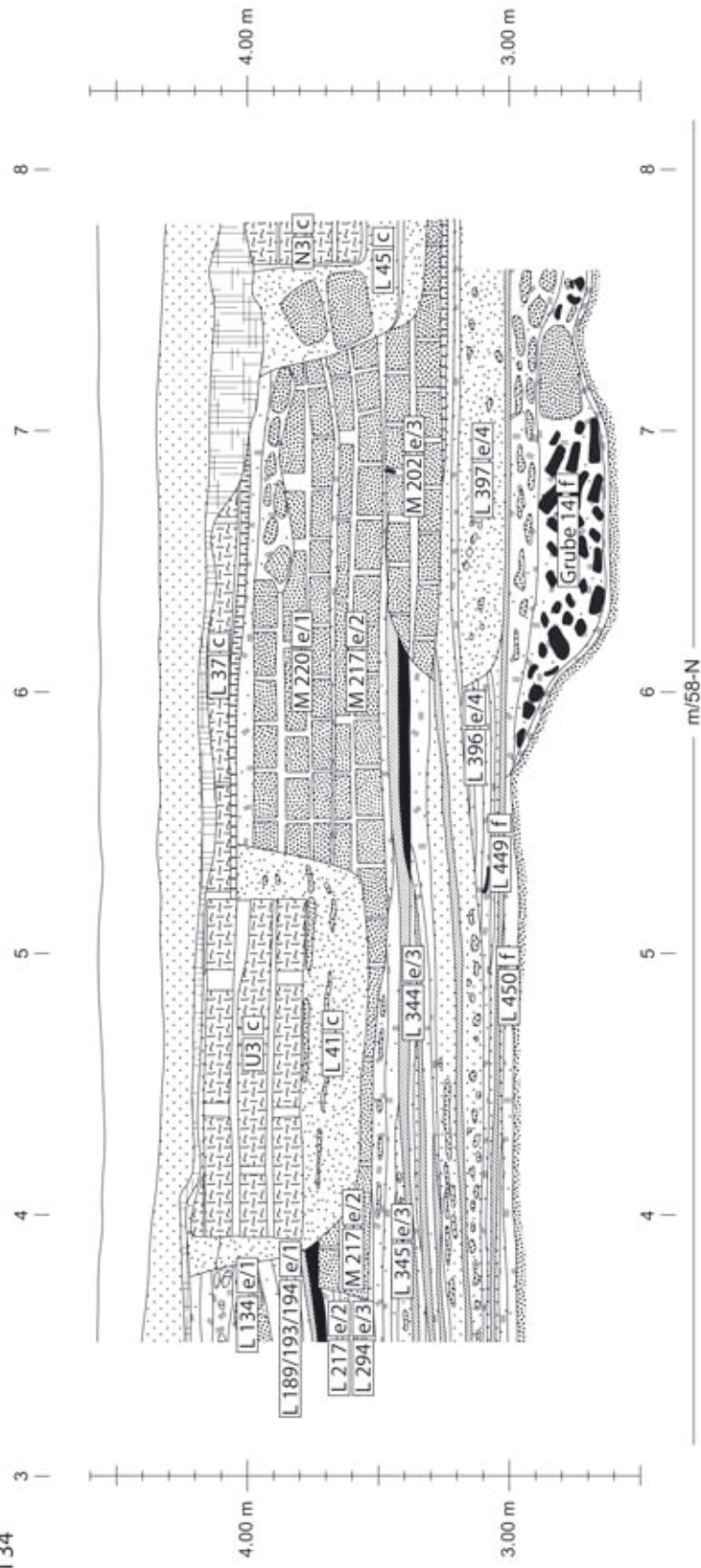

Profil 34

Profil 35

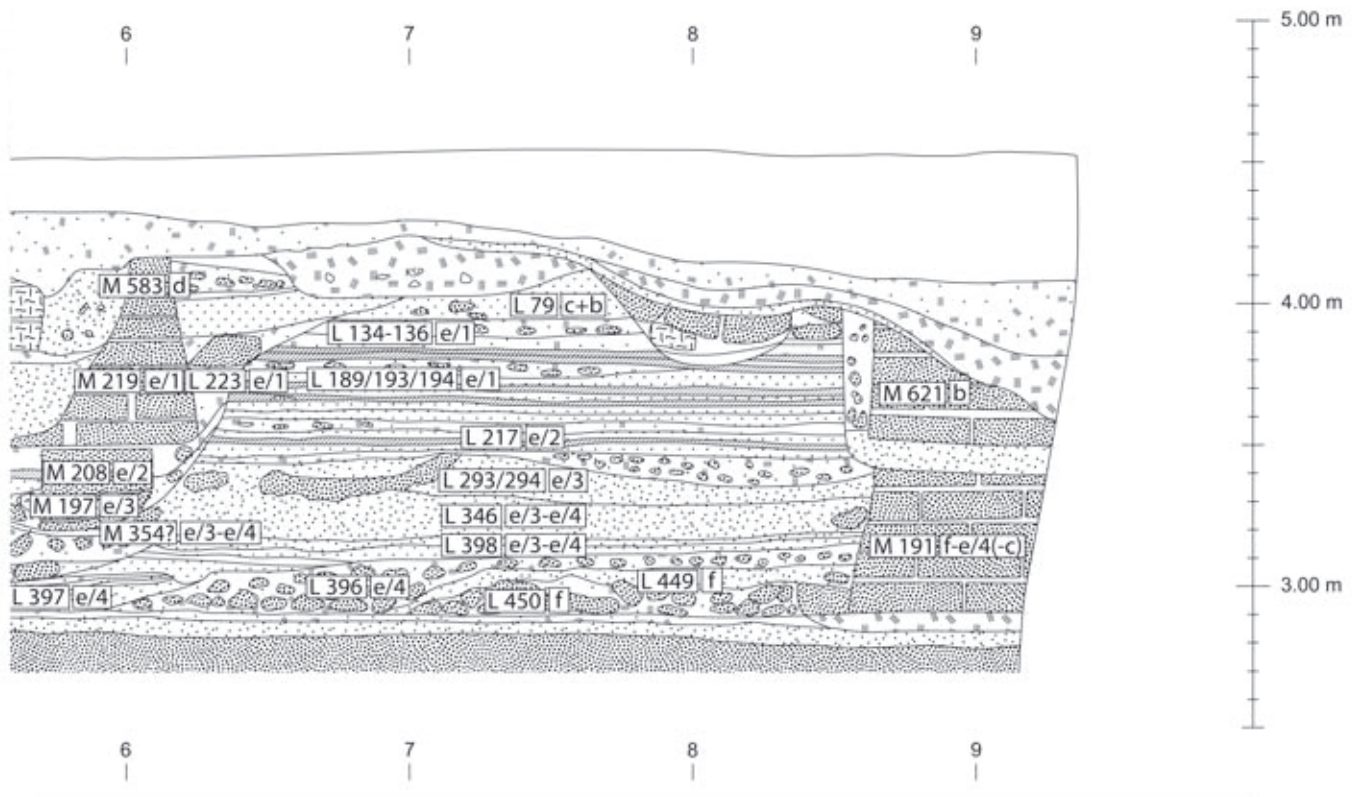
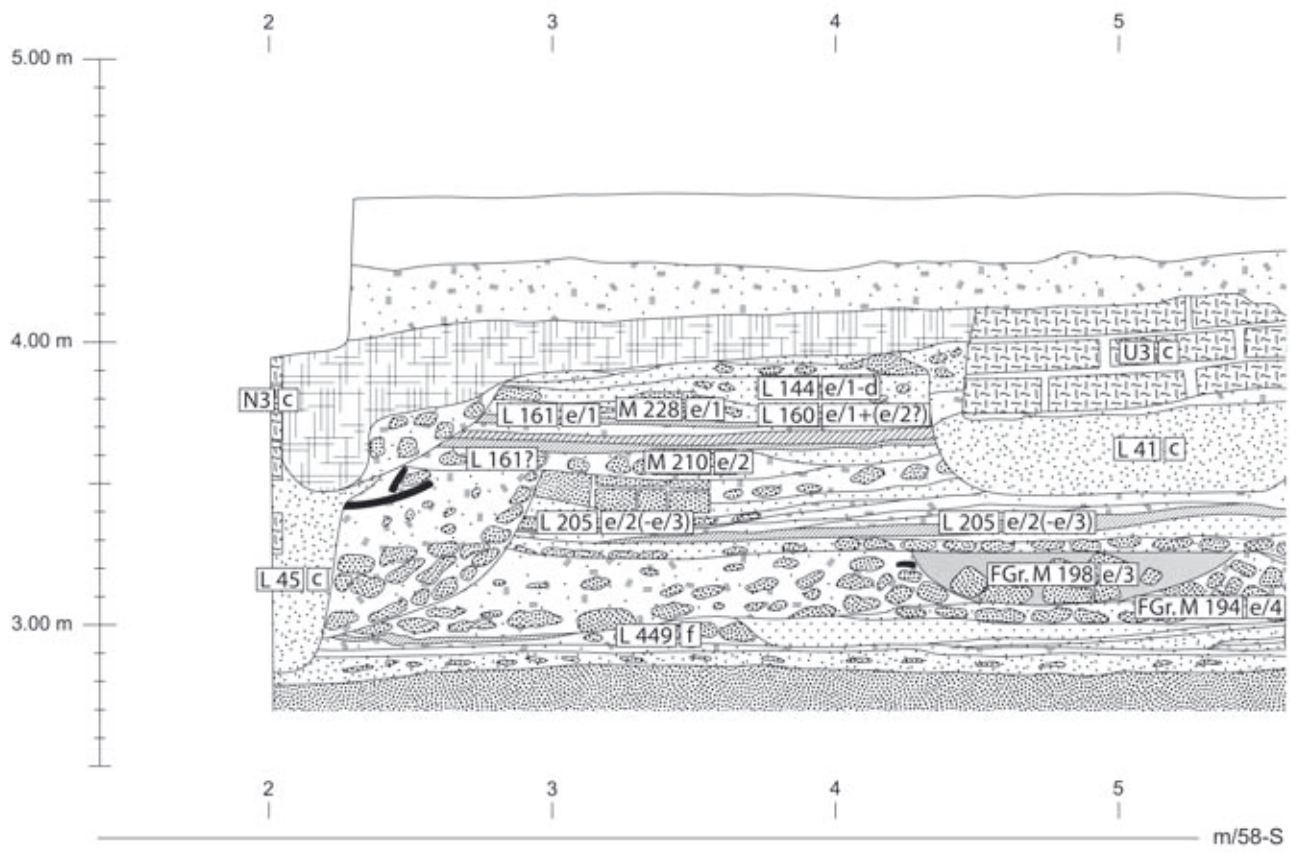

Profil 35



Profil 36

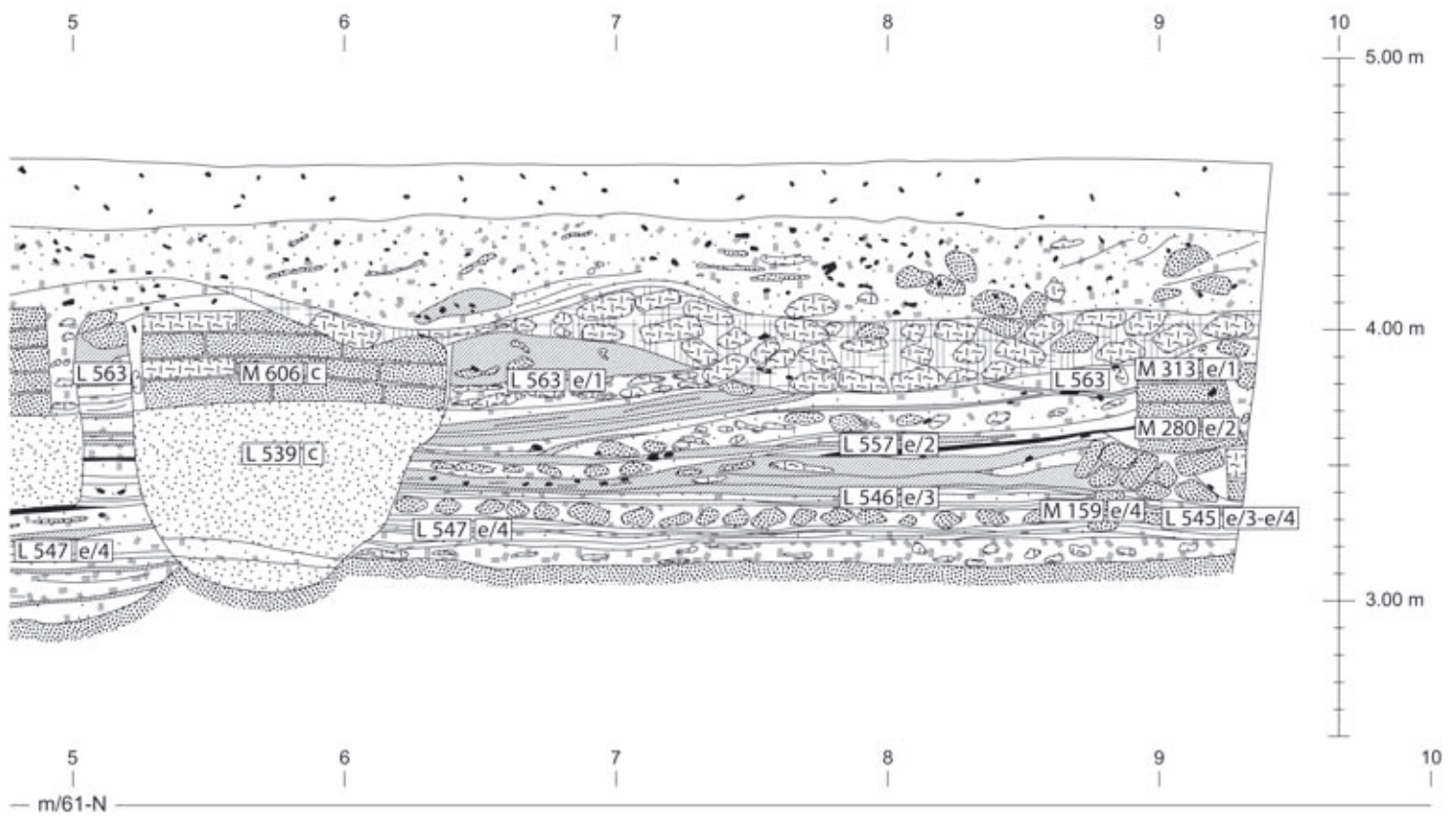
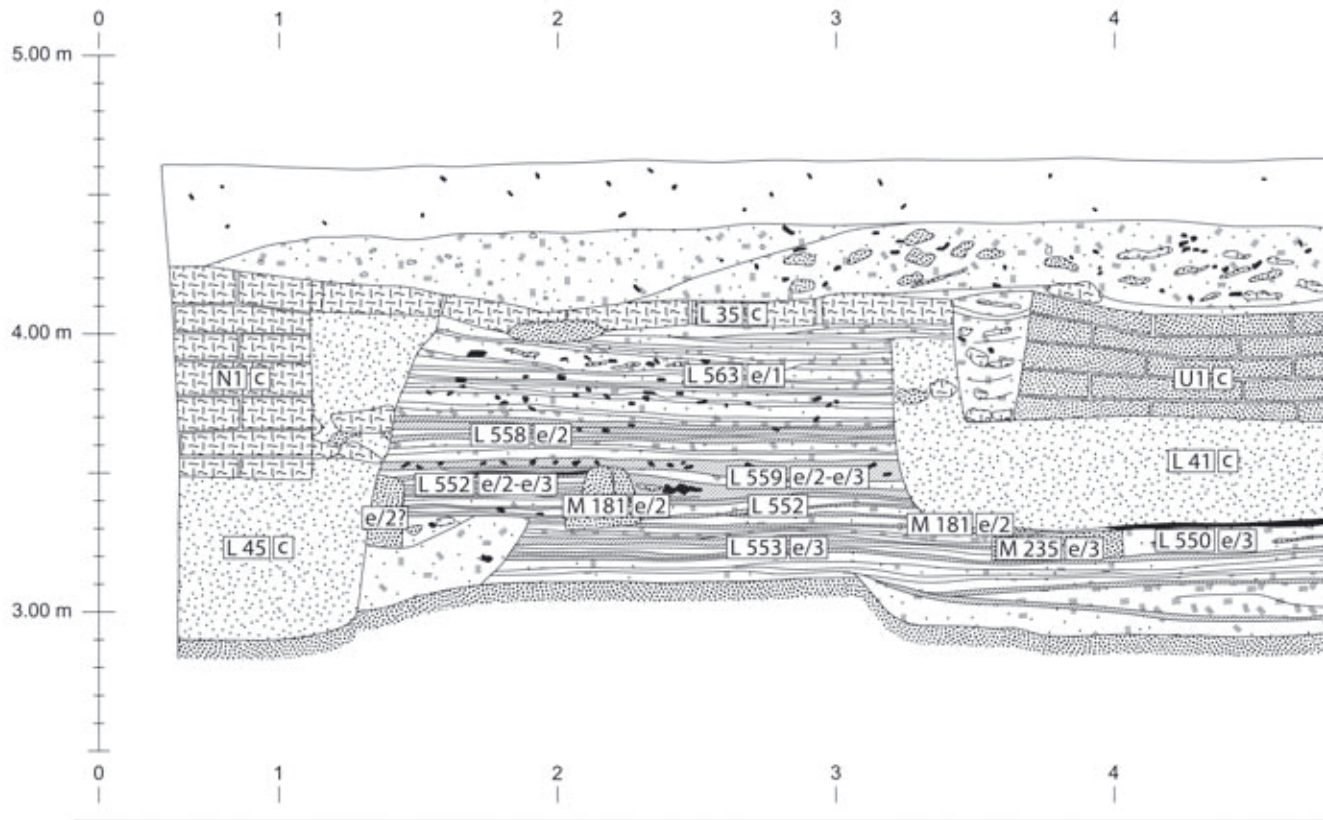

Profil 36

Profil 38

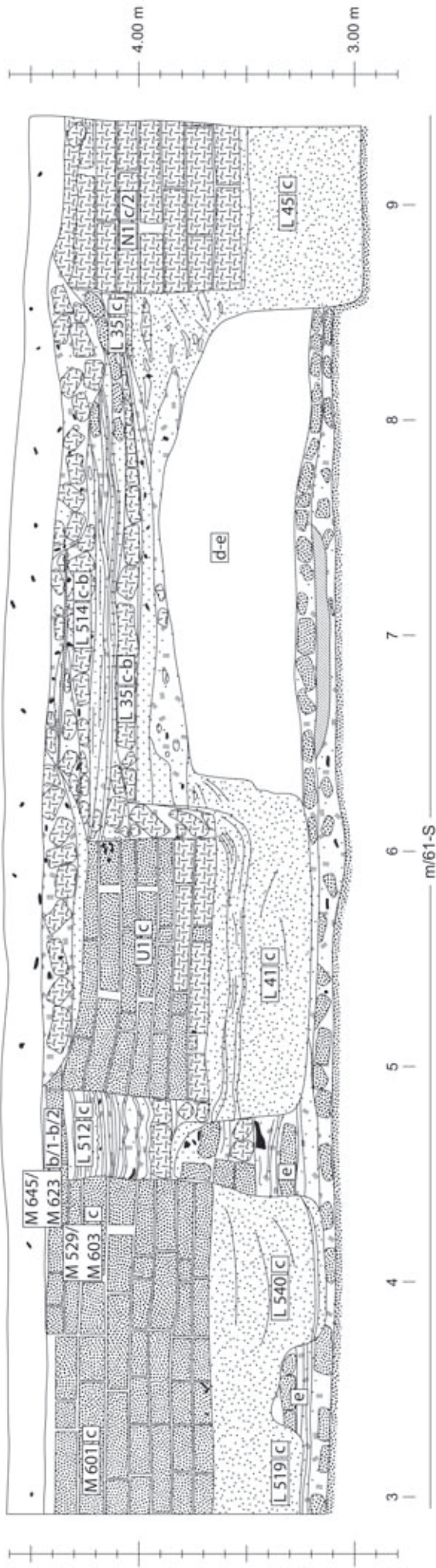

Profil 48

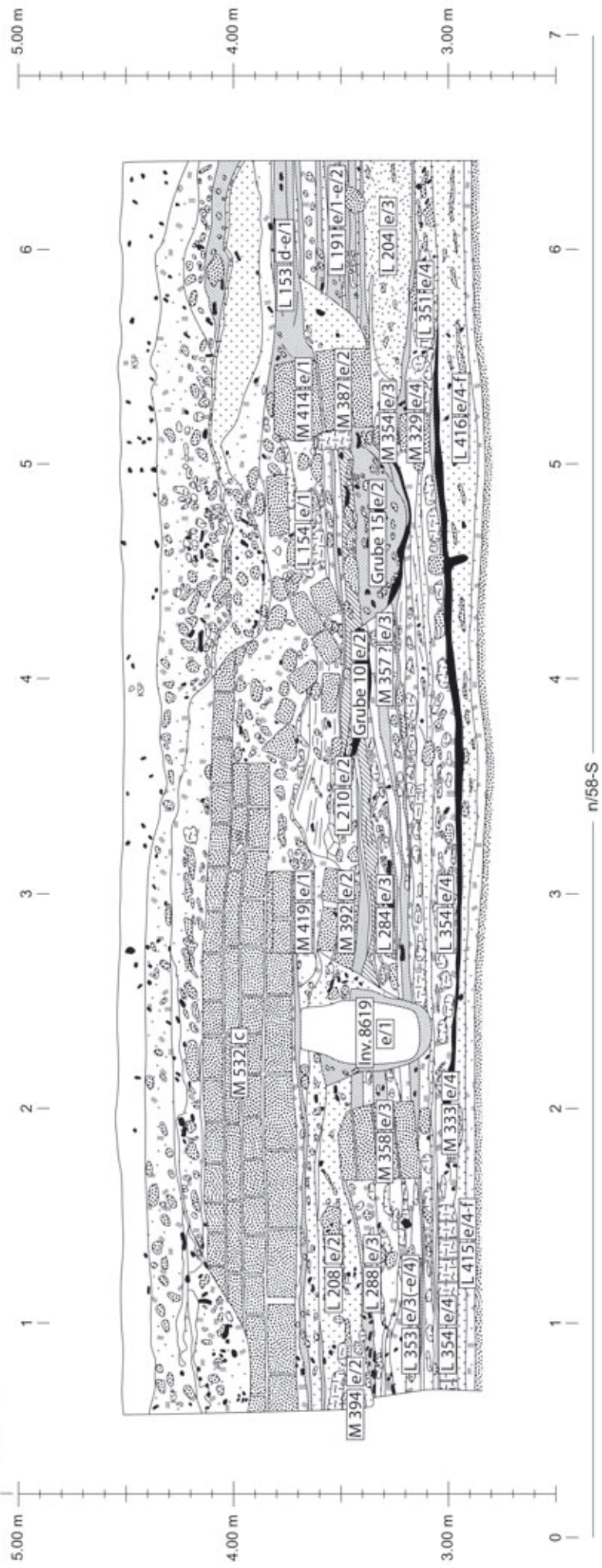

Profil 42

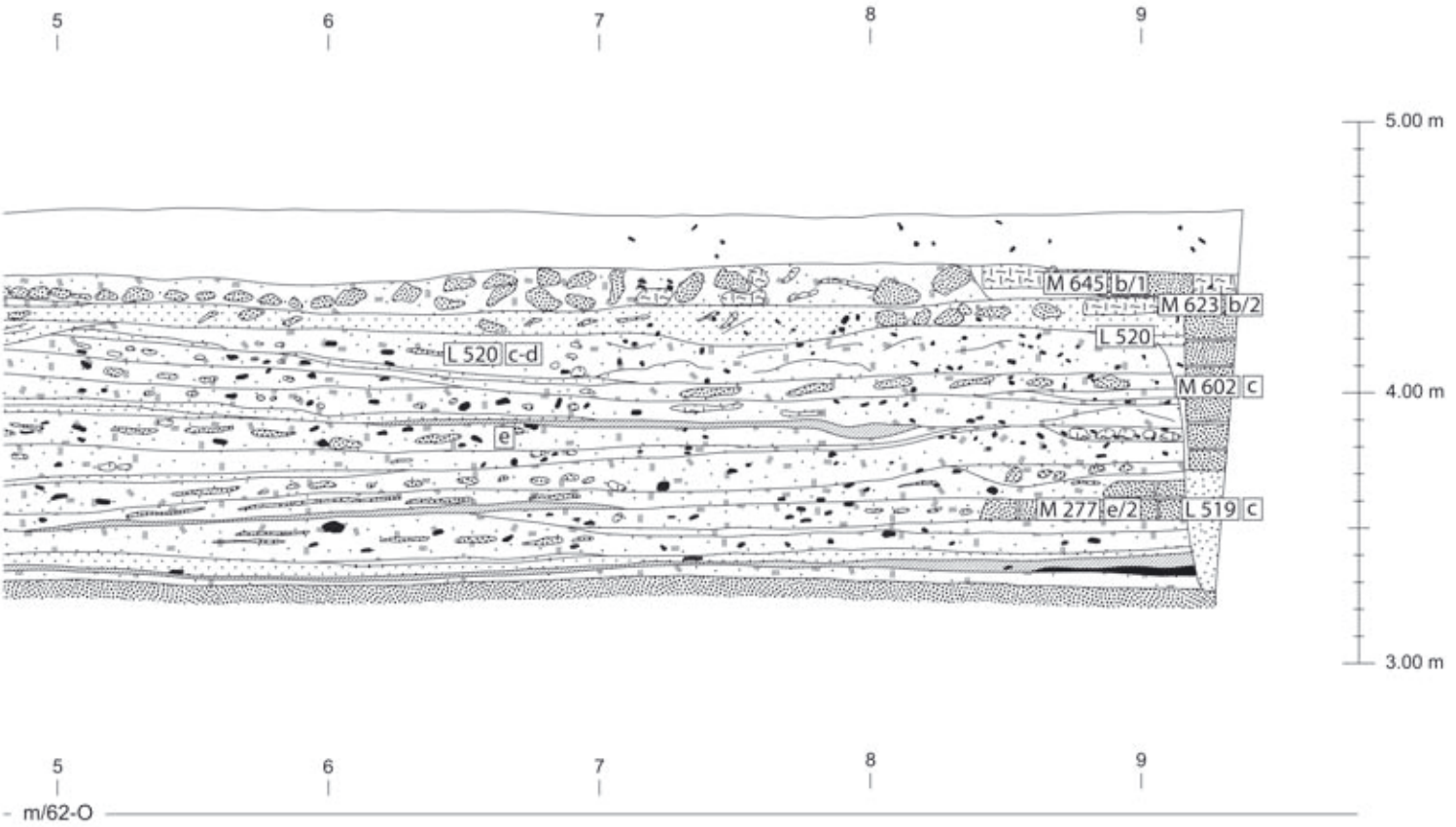
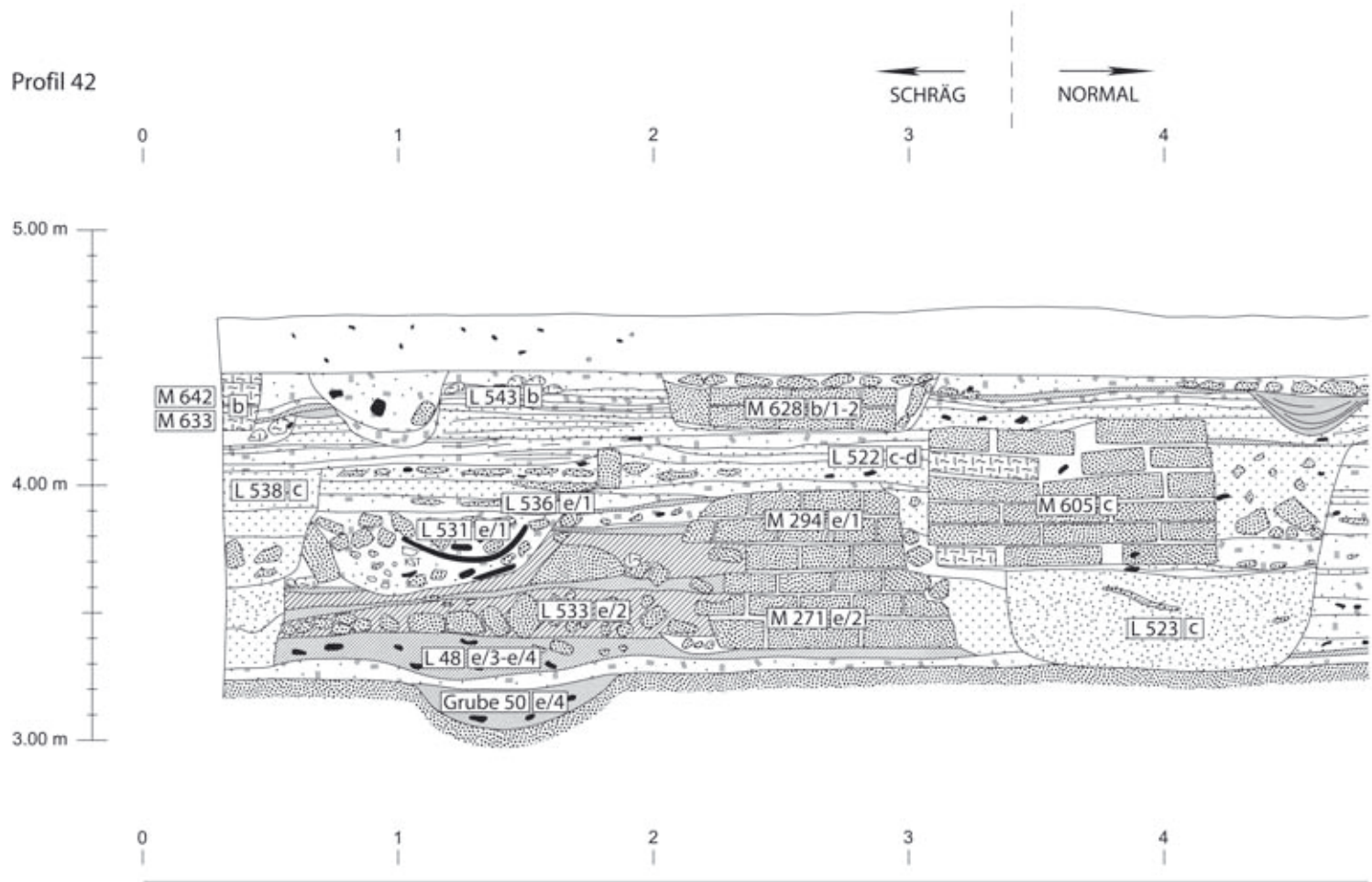

Profil 42

Profil 44

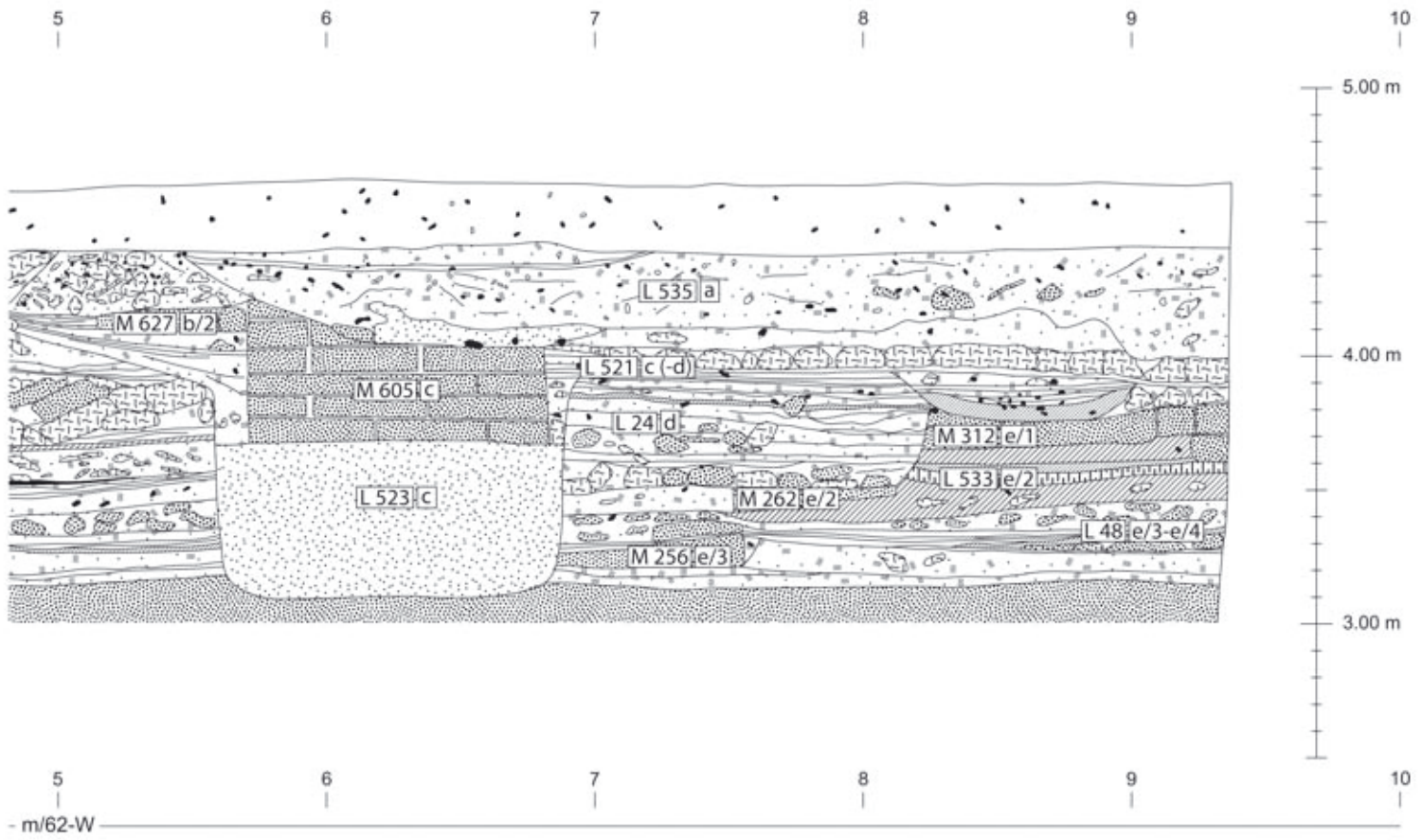
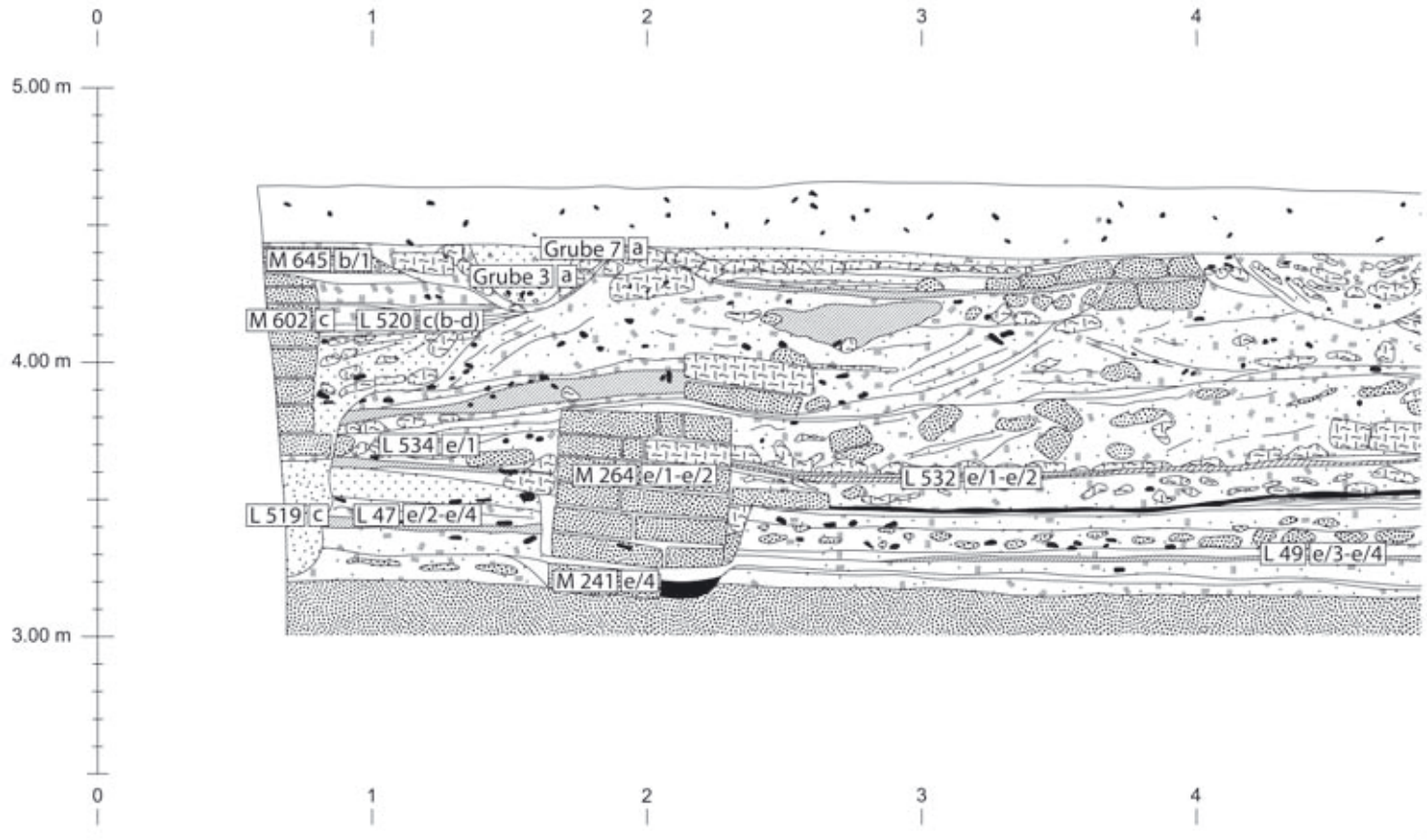

Profil 44

Profil 47

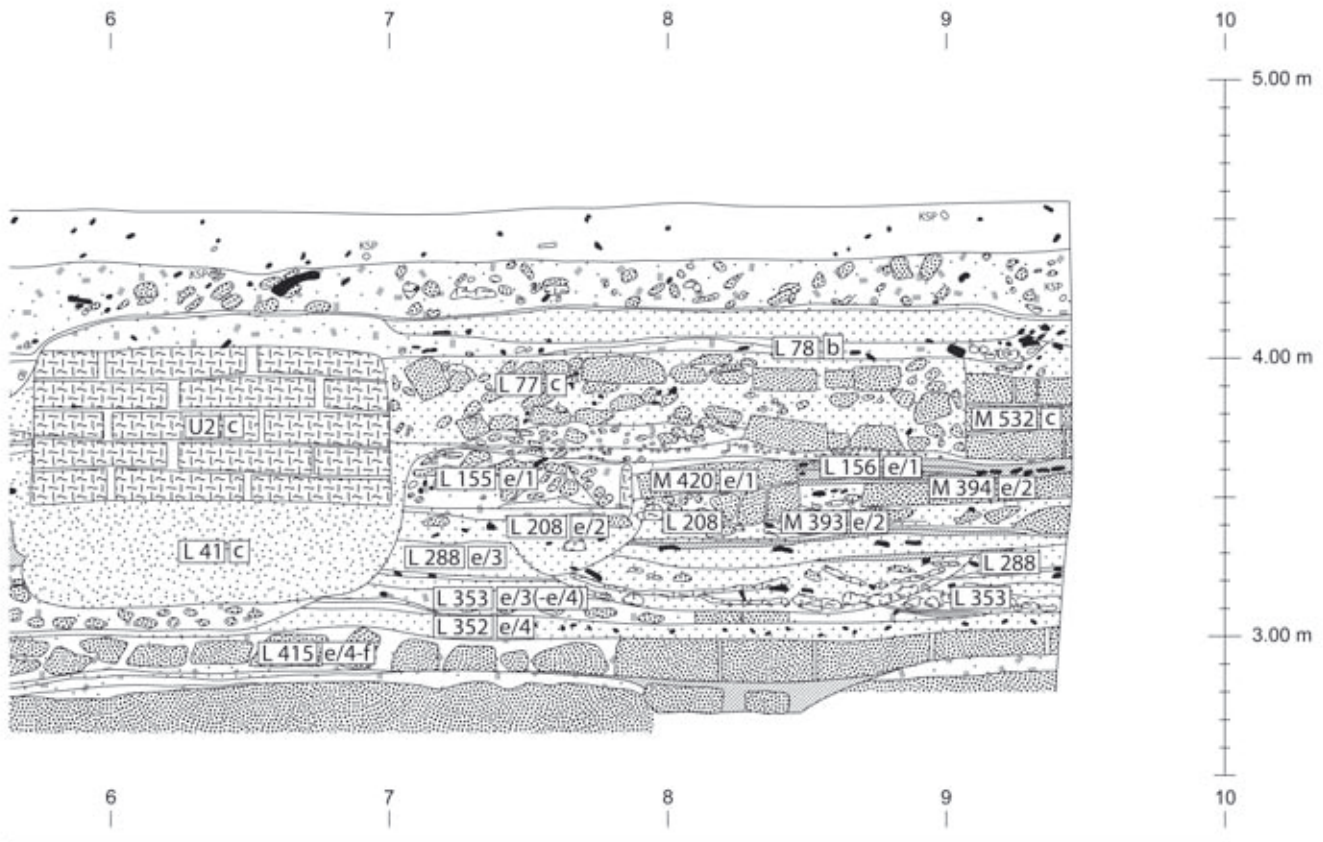
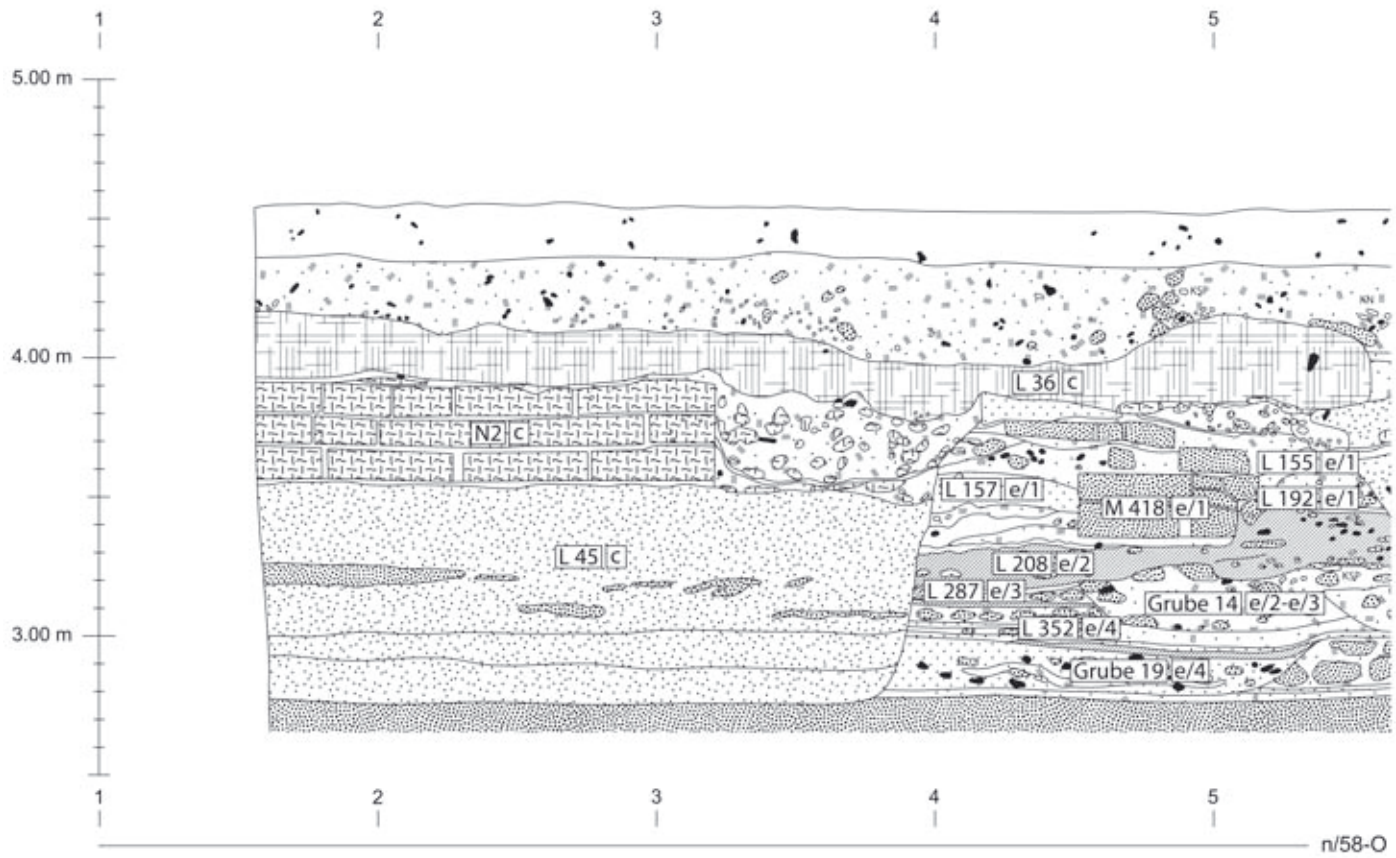

Profil 47

Profil 48



Profil 48

Profil 50

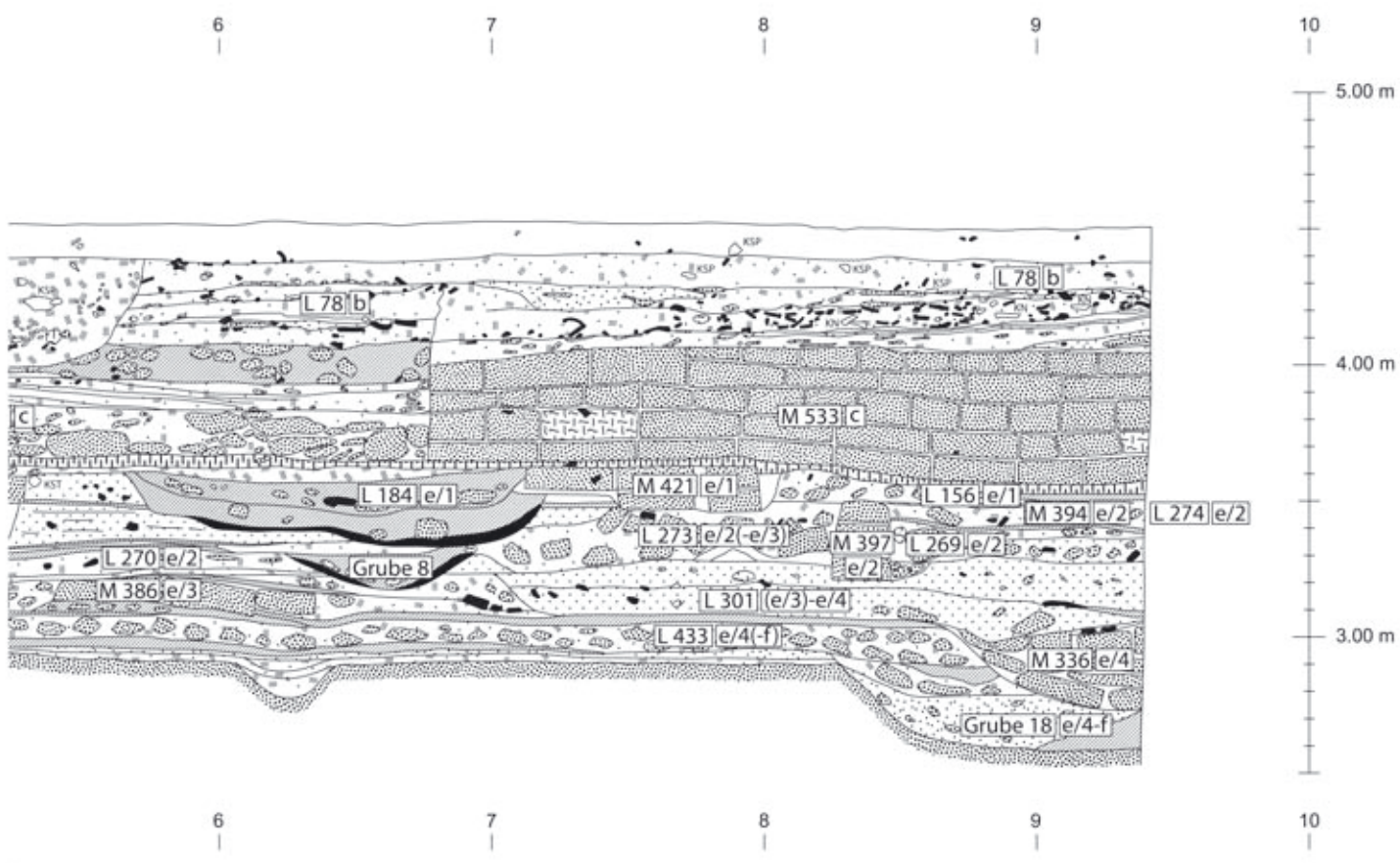
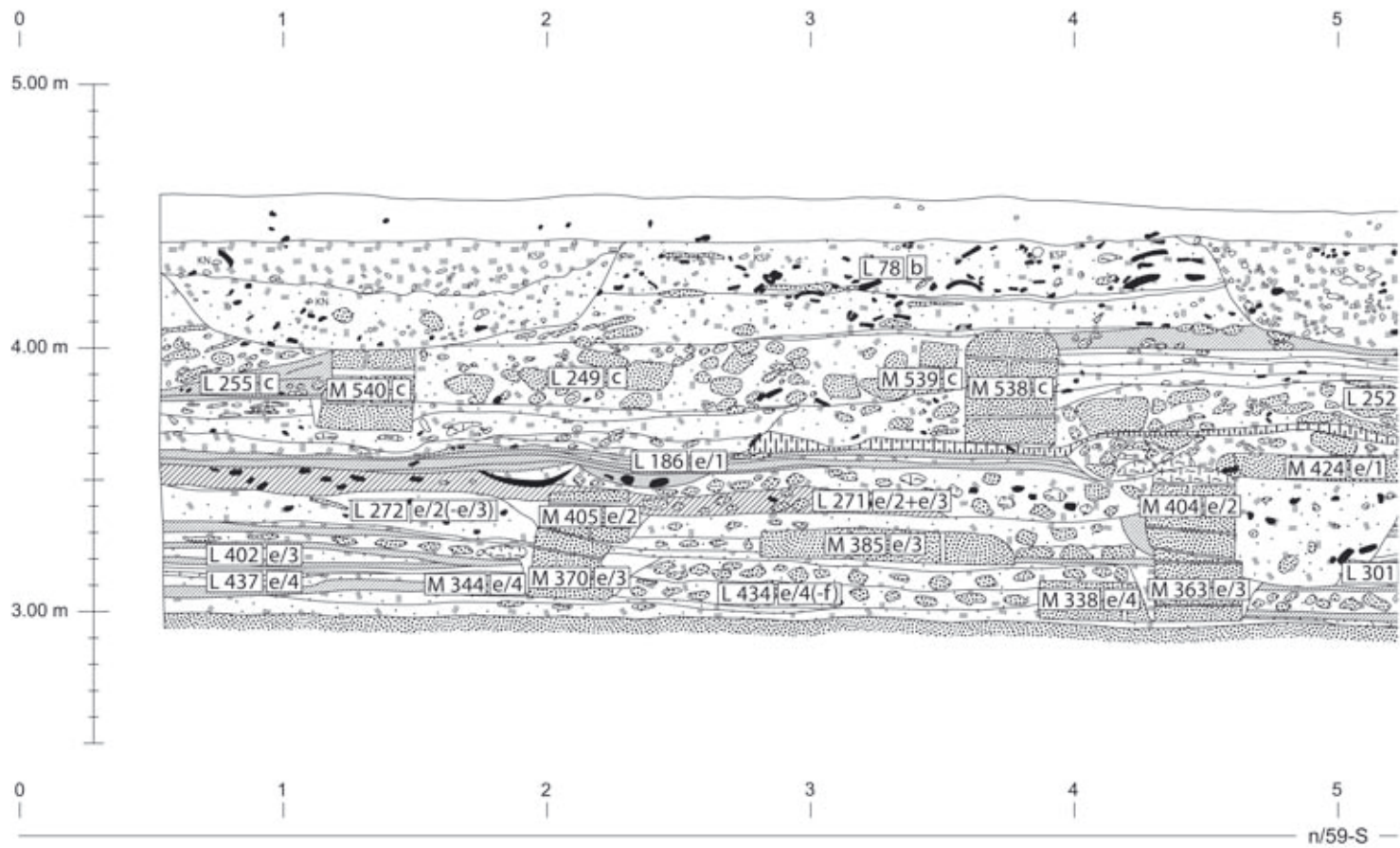

Profil 50

Profil 51

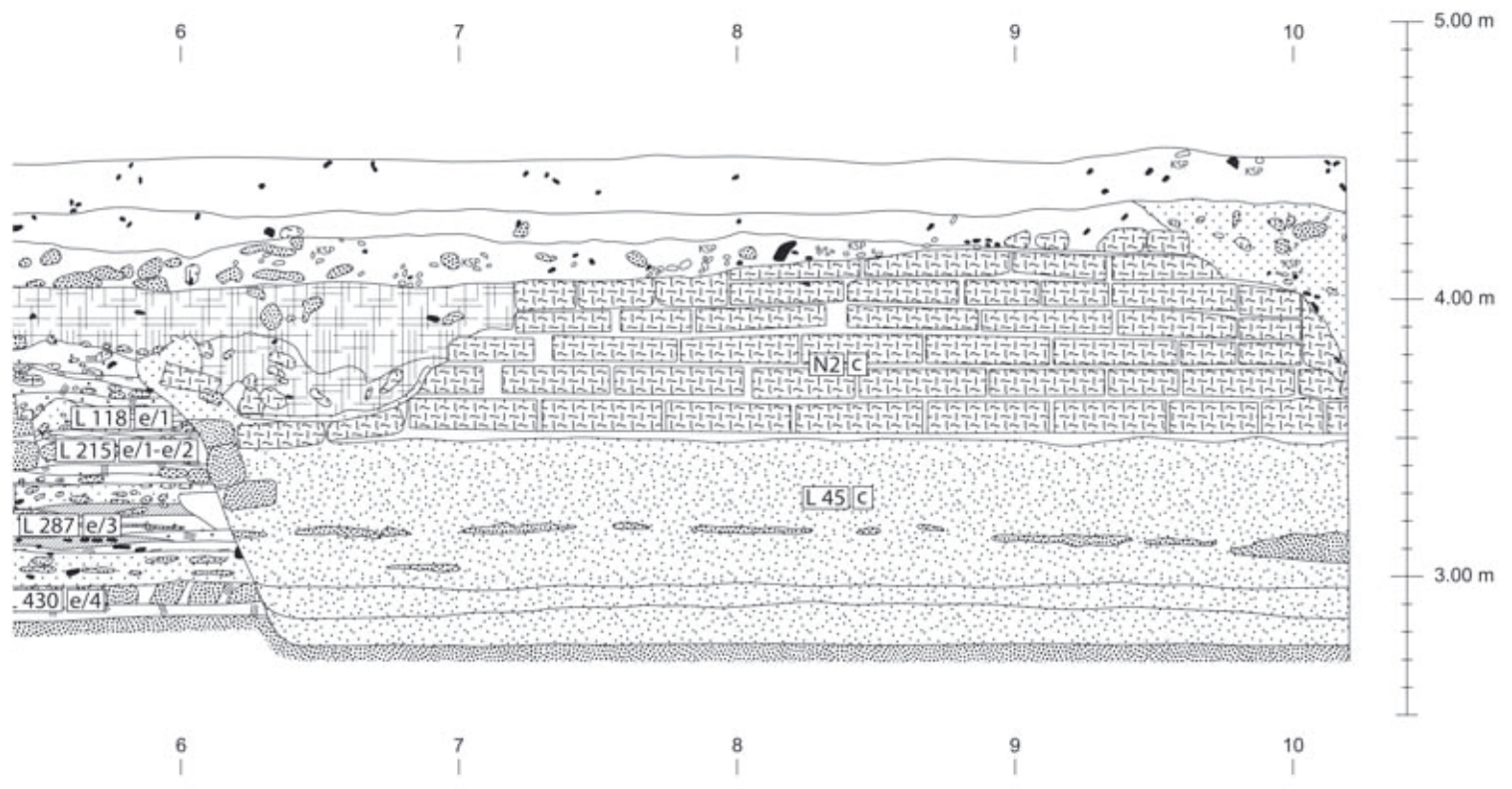
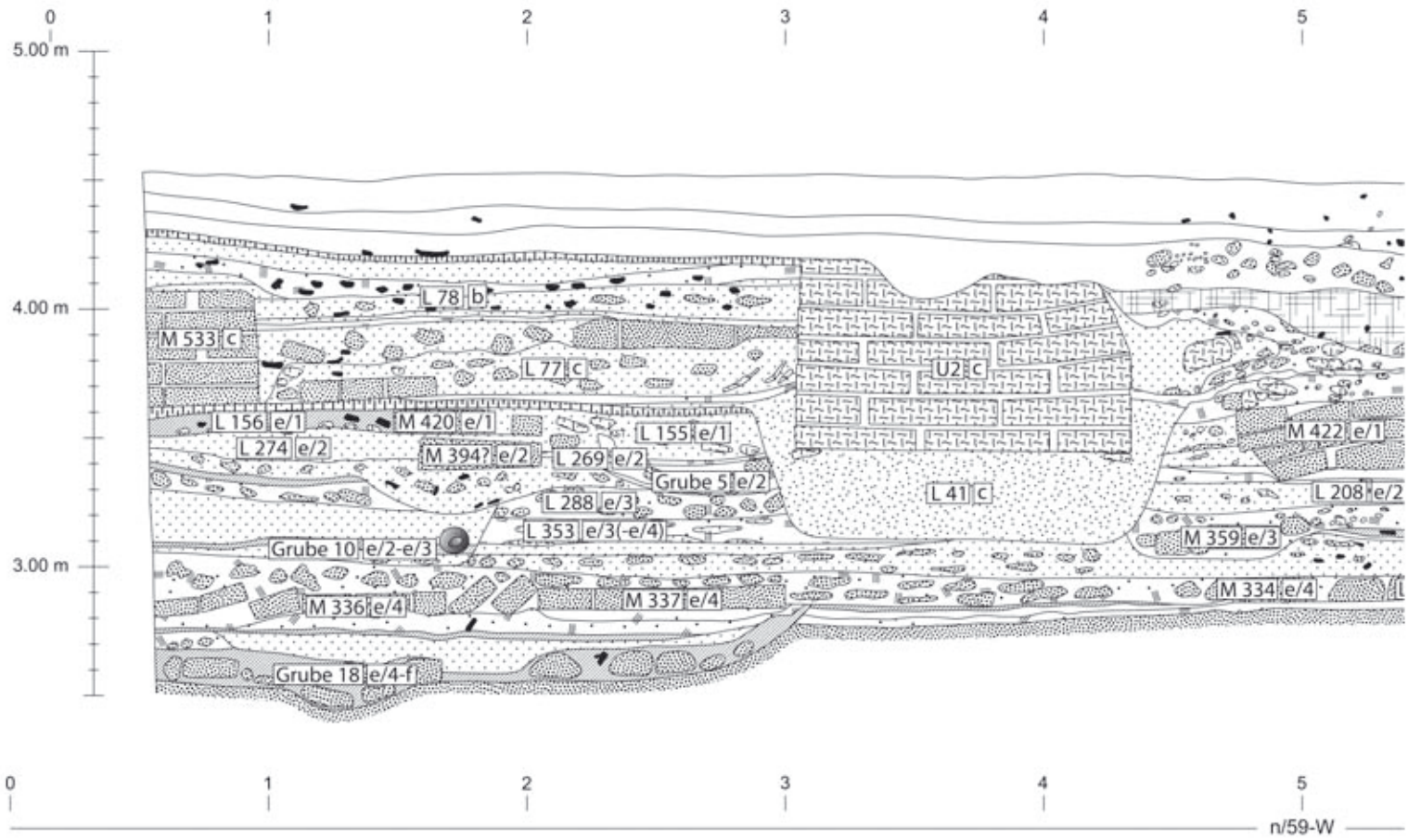

Profil 51



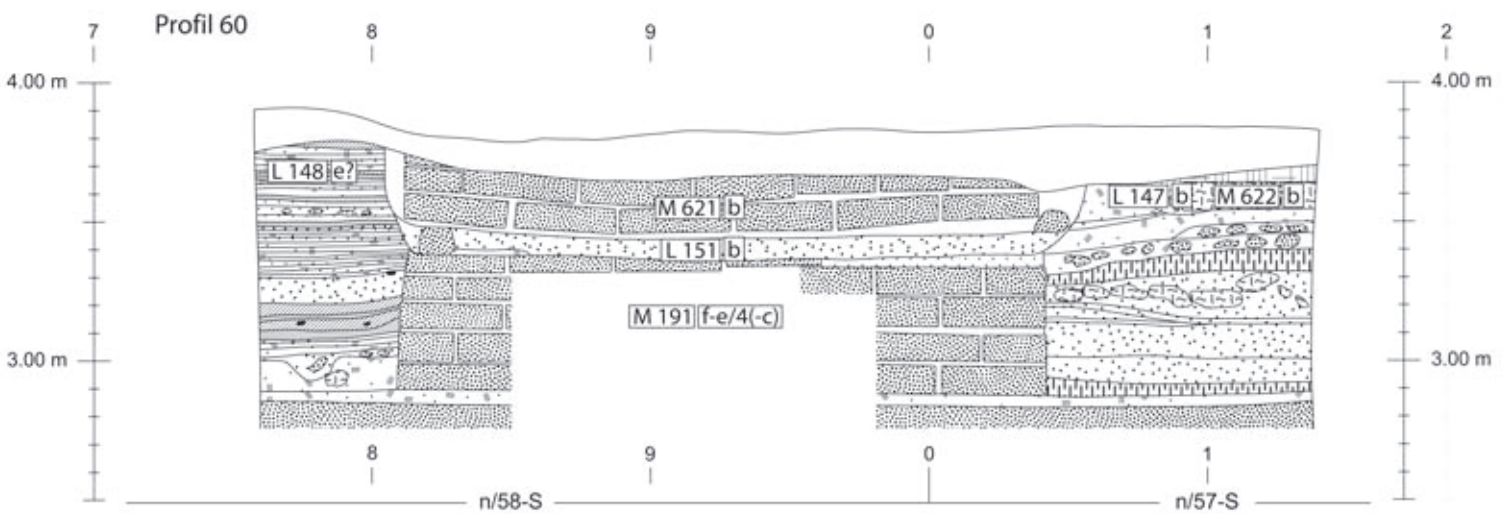
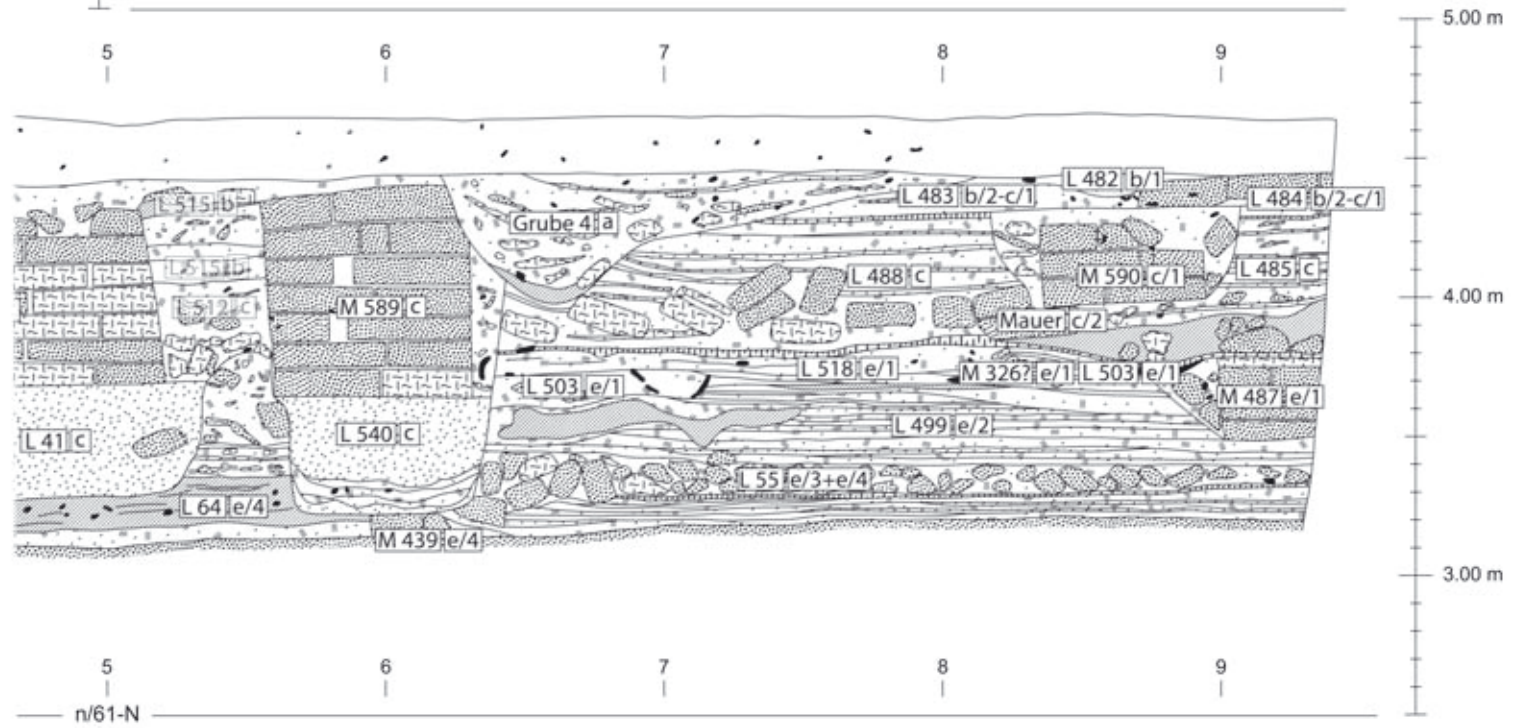
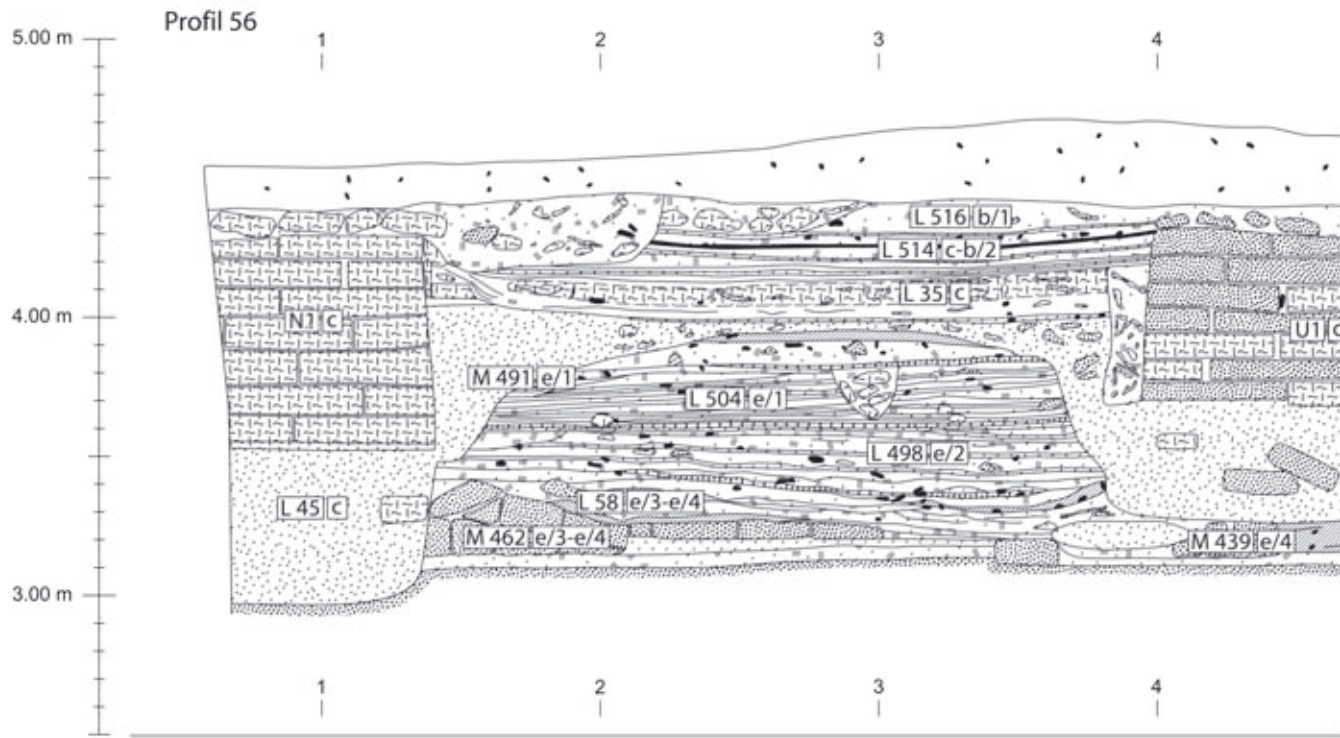

Profile 56, 60

Profil 66



Profil 62

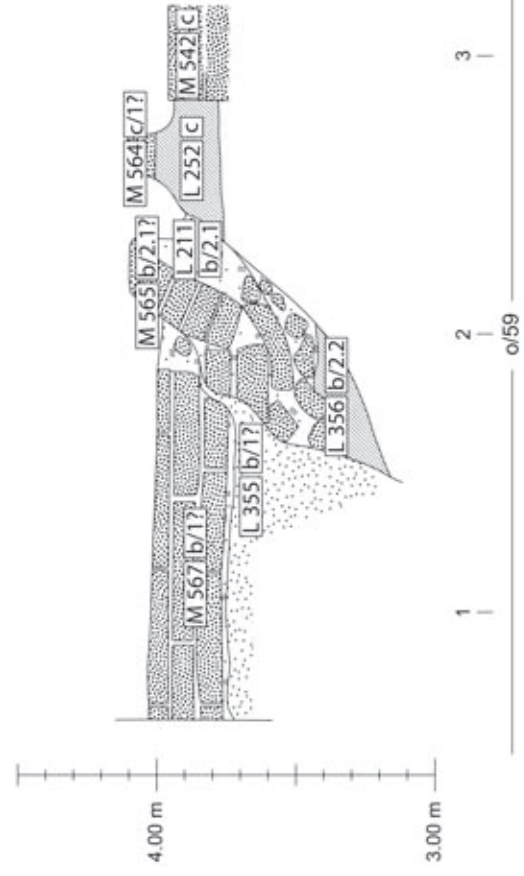

Profil 67

