

FROM HYKSOS TOMBS TO LATE PERIOD TOWER HOUSES TELL EL-RETABA – SEASONS 2015–2016

Sławomir Rzepka (SRz), Jozef Hudec (JH)**, Łukasz Jarmużek (ŁJ)*, Veronika Dubcová (VD)**, Lucia Hulková (LH)+, Anna Wodzińska (AW)* and Alena Šefčáková (AŠ)**+ with an appendix by Eva Stopková*+*

Abstract: *The preliminary report discusses Areas 4, 7 and 9, situated in the western and southern parts of the tell, where 21 occupancy phases (A – G3) have been identified so far. Three structures of an open settlement were unearthed which date to the SIP phase G3. The excavations corroborate the continuity of the SIP settlement to the early 18th Dynasty. Some 19th Dynasty structures were still in use during the 20th Dynasty; the architects of the 20th Dynasty fortress had to take them into consideration. In Area 9 houses of the Third Intermediate Period were uncovered, as well as buildings (including a “tower house”) of the Late Period settlement.*

Keywords: *Tell el-Retaba, Second Intermediate Period, New Kingdom, Third Intermediate Period, Late Period, cemetery, settlement, fortress*

The Polish-Slovak Archaeological Mission continued archaeological research at Tell el-Retaba, a site located in the middle of Wadi Toumilat, in 2015 and 2016.¹ Strong fortresses from Ramesside times controlled the route between Egypt and Syria-Palestine via the Sinai, but the site was occupied also before and after the New Kingdom. The excavation recorded archaeological remains of various occupation phases. The present extensive (but still preliminary) report discusses the results in chronological order, following a phasing system developed for the site in earlier seasons that is summarised below.

Excavations were carried out in three locations, designated as areas 4, 7 and 9, situated in the western and southern parts of the tell (for the location of the areas of excavation, see Fig. 1).

Phase	Dating	Main features
G3	Second Intermediate Period (SIP)	Open settlement and cemetery
G2	SIP	Open settlement and cemetery: enlargement of some buildings of the previous phase
G1	SIP/early 18 th Dynasty	No archaeological record yet
F4	18 th Dynasty (until Hatshepsut/Thutmose III)	Open settlement: Green House
F3	18 th Dynasty (until Hatshepsut/Thutmose III)	Open settlement: Black Houses
F2	18 th Dynasty (Thutmose III/Amenhotep II)	Scattered remains
F1	Late 18 th Dynasty	No archaeological record yet

* Institute of Archaeology, University of Warsaw

** Institute of Oriental Studies, Slovak Academy of Sciences/ Aigyptos Foundation, Bratislava

+ Austrian Academy of Sciences, OREA, Wien; FWF START Project Beyond Politics: Material Culture of Second Intermediate Period Egypt and Nubia Y754-G19

** Slovak National Museum-Natural History Museum, Bratislava/ Institute of Oriental Studies, Slovak Academy of Sciences.

** Institute of Oriental Studies, Slovak Academy of Sciences

¹ The mission is run under the auspices of the Polish Centre of Mediterranean Archaeology, University of Warsaw and involves also the Institute of Archaeology, University of Warsaw, Slovak Academy of Science and Aigyptos Foundation, Bratislava, and during the years 2015 and 2016 also a collaboration with the FWF START Project Beyond Politics: Material Culture of Second Intermediate Period Egypt and Nubia Y754-G19. Funding has been provided also by the Polish National Science Centre (grants

2012/05/B/HS3/03748 and 2015/17/B/HS3/00597) and by the Slovak Research and Development Agency (grant APVV-5970-12; Slovak Research of Ancient Egyptian civilization). A total of ten weeks of fieldwork took place in 2015 and 2016. The team directed by Sławomir Rzepka and Jozef Hudec included: Bartosz Adamski, Miroslav Černý, Veronika Dubcová, Emil Fulajtár, Anna Gręzak, Lenka Horáková, Lucia Hulková, Barbara Jakubowska, Łukasz Jarmużek, Katarzyna Kasprzycka, Tomáš Kmeť, Radka Knápek, Markéta Kobierska, Magdalena Konopová, Lukáš Kováčik, Marek Lintner, Ján Marko, Claire Malleson, Lubomír Podhorský, Agnieszka Poniewierska, Renata Rábeková, Agnieszka Ryś, Alena Šefčáková, Květa Smoláriková, Piotr Sójka, Eva Stopková, Katarzyna Szymańska, Katarzyna Trzczińska, Jerzy Trzcziński, Piotr Witkowski, Anna Wodzińska, Małgorzata Zaremba, Lucia Žilincová. The Ministry of Antiquities was represented by Sameh Ahmed Elsaid Hashem, Khaled Fareed and Eman Awad.

Phase	Dating	Main features
E4	19 th Dynasty	Earliest defence wall: core of Petrie's "Wall 1"; infant cemetery
E3	19 th Dynasty	Fortress of Ramesses II: extension of "Wall 1"; barracks/workshops
E2	19 th Dynasty	Fortress
E1	19 th –20 th Dynasty	Settlement and cemetery in the ruins of the fortress
D4	20 th Dynasty	Ruins of 19 th Dynasty fortress levelled; fortress of Ramesses III: Petrie's "Wall 2"
D3	20 th Dynasty	Petrie's "Wall 3", fortress
D2	20 th Dynasty	Fortress
D1	20 th Dynasty – Third Intermediate Period (TIP)	Fortifications abandoned and ruined
C4	TIP	Settlement
C3	TIP	Settlement
C2	TIP	Settlement
C1	TIP	Settlement
B	Late Period	Settlement with tower houses
A	Modern	Ottoman ovens and pipes, among others

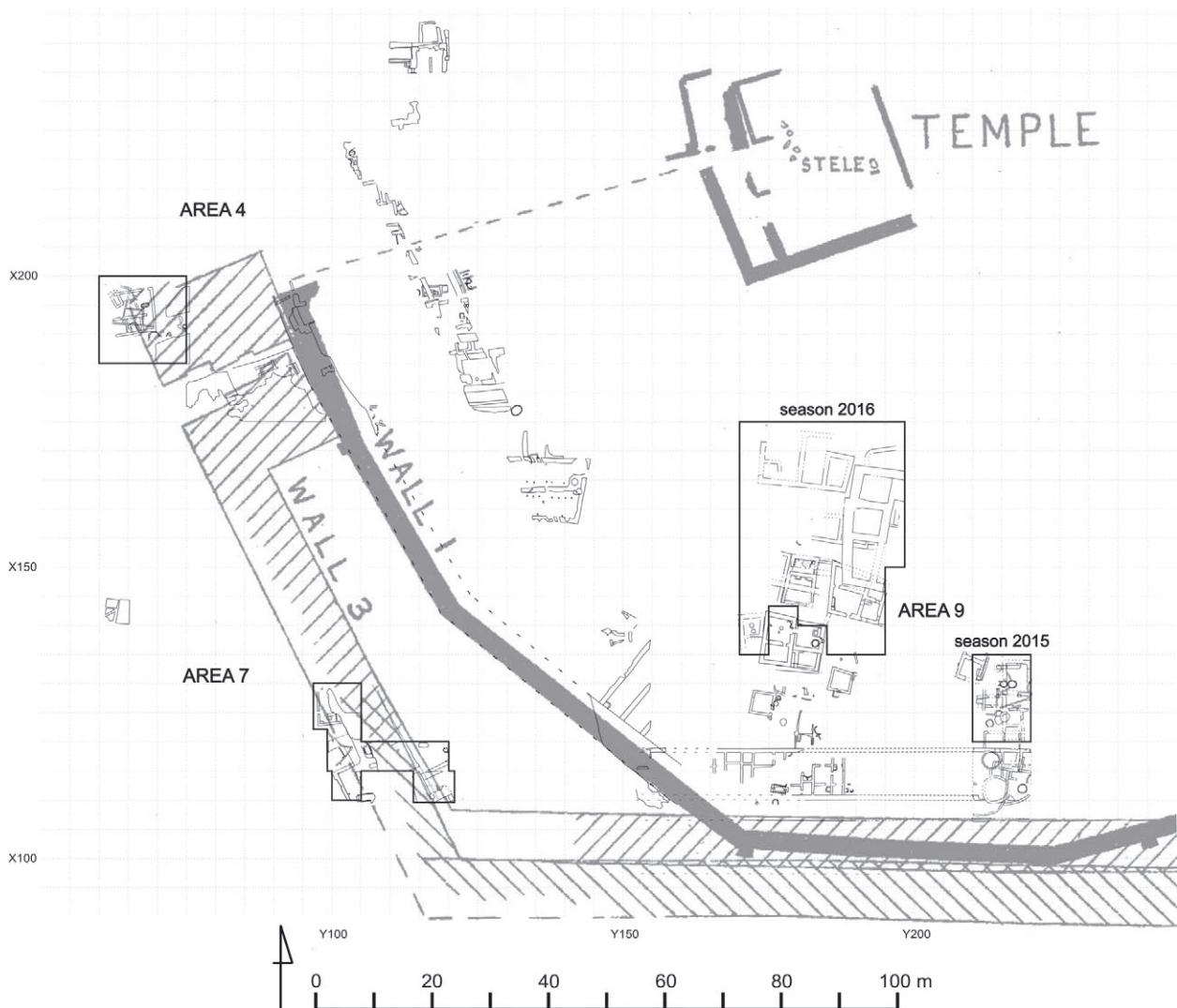

Fig. 1 General plan of the western part of the site with location of areas excavated in 2015 and 2016 (Drawing Ł. Jarmużek, spatial data in Area 4 and Area 7 (2014–2016) by E. Stopková, based on PETRIE and DUNCAN 1906, Pl. XXXV).

Areas 4 and 7 are both important for a better understanding of the transition between the SIP and the New Kingdom, as the SIP levels are

directly underneath the settlement structures of the early New Kingdom. Research in both areas has not been finished yet.

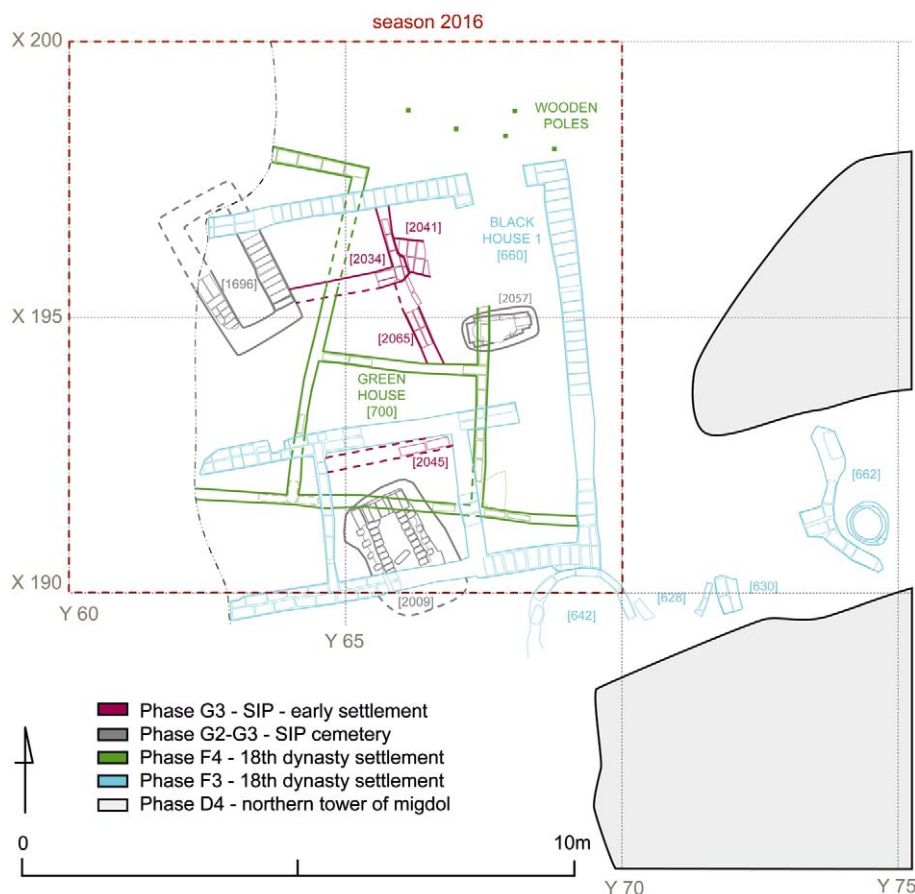

Fig. 2 Excavations in Area 4 (spatial data 2014–2016 E. Stopková, drawing L. Hulková)

Area 4 is the closest to the modern settlement and immediately endangered by modern occupancy. A local inhabitant has claims to the adjacent plot of land, northwards from the northern tower of Migdol. Therefore, future excavations are urgently needed to collect information on the archaeological situation here. The excavations in 2016 thus focused on the north-western part of Area 4 (Fig. 2). Earlier excavations undertaken in the area² indicated that more or less undisturbed stratified remains from the early 18th Dynasty and the SIP could be expected under the mudbrick platform, which was built beneath the northern Migdol tower and the defence wall (Petrie's Wall 2) of the 20th Dynasty fortress of Ramesses III.³ The eastern edge of this platform, reaching under Petrie's Wall 2 north of the Migdol gateway, was researched from the construction engineering's point of view.

The excavations in 2015 and 2016 exposed further occupation layers of Black House 1, which had already been discovered in the 2011 season.⁴

Black House 1 was atop of an older building made of greenish mudbricks from the early 18th Dynasty (called the Green House). Strata connected to it were excavated in squares Y60X195, Y65X195, Y60X190 and Y65X190. Even older walls of sandy yellowish mudbricks were unearthed below these houses on the aggradation mound in Area 4 in 2015. The walls belonged to a strongly damaged and probably robbed SIP tomb of considerable dimensions; its NE corner had been discovered in 2011.⁵ In 2016, further SIP burials were discovered underneath the rooms of Black House 1 and Green House, however, some of them could not be excavated due to time constraints.

In Area 7 (Fig. 3), a part of Black House 3 architecture of the early 18th Dynasty was excavated in square Y95X125. The stratigraphic situation in this square was less complex than in Area 4. However, strata of earlier occupation levels were also unearthed here. The square was excavated down to the bedrock, except the layers covered by Petrie's Wall 2.

² RZEPKA *et al.* 2016, 193–226.

³ RZEPKA *et al.* 2014, 55–64.

⁴ RZEPKA *et al.* 2014, 55–64.

⁵ RZEPKA *et al.* 2014, 55, fig. 28.

Fig. 3 Excavations in Area 7 (spatial data 2014–2016 E. Stopková, drawing L. Hulková)



Excavations in square Y95X115 followed up the works from the 2014 season.⁶ The upper layers in the square could be dated by some small finds and pottery, ranging from the Late Period to the Third Intermediate Period. A massive mudbrick platform/floor (?) has been unearthed below these layers, running approximately in a north – south direction. An older wall, made of yellowish sandy bricks, runs under the platform from the north-eastern corner of square Y95X115.

Work in square Y105X105 was aimed at ascertaining, whether the SIP walls, unearthed in squares Y100X115, Y100X110, Y115X115 and Y115X110 in previous seasons,⁷ continue or intersect within square Y105X105. Due to the complex stratigraphic situation, it was not possible to reach the corresponding SIP strata in the short campaign.

Work in squares Y115X110 and partly Y120X110 also followed up the excavations of season 2014.⁸ An occupation level of a SIP settlement phase, indicated by a rich potsherd layer, was

unearthed in a room flanked by walls in the north and south.

In **Area 9** remains of 19th and 20th Dynasty fortresses were explored during the 2015 season. In 2016 several houses of the Third Intermediate Period settlement were uncovered in the western part of this area, as well as several buildings (including a so called “tower house”) of the Late Period settlement.

1. The Second Intermediate Period [phase G]

LH, JH, AŠ

During the two campaigns in 2015 and 2016 a number of structures dating to the SIP were explored. The excavated structures seem to fit within the already known phases⁹ of the SIP settlement history. Notwithstanding, as a relatively large space separates the exposed remains in Areas 4 and 7, a slight revision of the phasing might be necessary in the future.

⁶ RZEPKA *et al.* 2015, 101–102.

⁷ RZEPKA *et al.* 2014, 39–56.

⁸ RZEPKA *et al.* 2015, 101.

⁹ RZEPKA *et al.* 2015, 98.

1.1. Earlier open settlement (phase G3, Areas 4 and 7)

Three structures were unearthed which date to phase G3. Two of them, the Eastern and Western House, are from Area 7 and one other from Area 4. They formed integral parts of an open settlement.

The walls, discovered during the campaign 2016 in Area 4, are badly preserved. Only a part of a room, probably belonging to a larger architecture, was exposed. It is not sure whether the building unearthed so far was the earliest structure on the ground; some yellowish bricks were observed deeper eastwards from the wall [2034], possibly belonging to even older phase. Further archaeological research will be needed to draw a reliable interpretation.

The uncovered mudbrick structures in Area 4 are oriented slightly differently from those in Area 7. This would not be a surprise,¹⁰ as the settlement seems to be organic, not a planned one.¹¹

In Area 7 archaeological works unearthed further rooms belonging to two structures,¹² partly excavated already in 2012¹³ and 2014.¹⁴ The excavation area was enlarged in 2015; however, the excavations did not continue here in 2016.

1.1.1. The Eastern House in Area 7 – walls [1309] / [1721] / [1739] (Fig. 3)

In square Y115-X115, eastwards of Petrie's Wall 2, three consecutive settlement stages were identified, all dated into the general stratigraphic phase G3. As the natural subsoil was not reached, it is possible that the settlement activity may date even further back.

The earliest traced remains are ashy layers (1729 = 1733/1734).¹⁵ These layers have not been removed yet. They consisted of ashy domestic refuse mixed with animal bones; they filled a room between walls [1309] and [1721] that is about 3.5 m wide. The length of the room cannot be determined because its E and W part are outside of the excavated area. The thickness of the wall

[1309] varies between 1½ bricks and two bricks¹⁶ (37×17–20×10 cm), while wall [1721] is two bricks thick (31×17×10 cm). A small part of the floor (1722) associated with wall [1721] was preserved above this ashy layer.

During the following occupational phase, a new one brick thick wall [1739] was built over wall [1721]. This wall was very badly preserved, only about 10 cm of the original height is still standing. Remains of a floor (1746) and a room fill (1745) associated with this wall are preserved in a narrow stripe north of wall [1739].

Spreading in the whole room between walls [1309] and [1739], the layer (1442) marks the last occupation phase of G3. In the south it covers a large number of broken storage vessels lining wall [1309] that were placed directly atop of ashy layers (1729=1733/1734). It is partly covered by the destruction layer (1682) associated with wall [1309], marking the end of phase G3.

There are not many finds apart from pottery and animal bones associated with this room. However, the steatite (?) object S2111 may point to some kind of production activity undertaken in this area.

1.1.2. The Western House in Area 7 – walls [1766] / [1423] / [924] / [930] (Fig. 3)

Westwards of Petrie's Wall 2 a further three squares Y95-X125, Y95-X115 and Y105-X105 were explored. However, only in square Y95-X115 the layers belonging to phase G3 were reached. This square adjoins west to the area of the large building uncovered in 2014.¹⁷ Wall [1766] that continues further eastward underneath the large wall [1391] was exposed. Southwards of it, an ashy fill (1765) and a fireplace (1769) associated with wall [1766] were uncovered. They are a continuation of the floor (1457) found in 2014. The sandy layer (1767) north of wall [1766] seems to be already outside of the building. This corresponds well with the findings of previous seasons.

¹⁰ Differences in orientation of single settlement structures can also be observed in other SIP settlements, see REDMOUNT 1989, 232–233, 236, 238, 240–241.

¹¹ BADER 2008, 49.

¹² The rooms excavated in Area 7 seem to belong to two distinct houses. However, the exact relationship between these two structures is obscured by a later fortification wall (Petrie's wall 2).

¹³ RZEPKA *et al.* 2014, 52–56.

¹⁴ RZEPKA *et al.* 2015, 100–103.

¹⁵ This layer was first documented as one stratigraphic unit (1729), but later it was decided to separate it into two layers (1733) and (1734), as the remains are more compact in the E than in the W.

¹⁶ This may be due to the bad preservation state of parts of wall [1309].

¹⁷ RZEPKA *et al.* 2015, 101.

Fig. 4 SIP architecture in Area 4 (spatial data 2014–2016 E. Stopková, drawing L. Hulková)



1.1.3. Architecture in Area 4 – walls [2034] / [2045] / [2065] (Fig. 4)

A mudbrick wall [2034] with associated room fills (2035), (2038), (2039) and (2040) were excavated underneath room 4 of Black House 1. A course of the wall was exposed just about 1.3 m in NNW and 1.94 m in a WSW direction; the structure which it belongs to very probably continues further to the north, out of the excavated area. The WSW part of the wall is one brick thick, the NNW part only ½ brick thick; this may be a result of later destruction. The wall is built of pale grey mudbricks (40×16×10 cm) lying on a bed in stretcher bond. In most places only two rows of bricks are preserved, up to about 21 cm of the original height of the wall.

The unexcavated structure [2065] south of wall [2034] seems to be a further part of a larger building. Even wall [2045] may be a part of the same structure; the space between walls [2065] and [2045] have not been excavated yet, thus this assumption should be proven by further archaeological research.¹⁸

Only the room fill associated with wall [2034] could be excavated. In the NW a loose, light brown sandy room fill (2038) and underlying yellowish sandy fill (2040) were recognised. Part of the light brown sandy fill (2039) of the SW room was also excavated. Based on the present state of research, the architecture seems to have a domestic character.

¹⁸ For convenience reasons, this structure will be referred to as [2034] in the following text.

The finds – scattered animal bones, grinders¹⁹ S2775 and S2833 and pottery – or associated structures do not point towards usage as a cult place. In the layer (2007), presumably outside of the building southwards, further finds pointing towards domestic/industrial activity like red ochre lump S2749, scraper (?) made of reused pottery sherd S2797 or a flint blade S2747 were found. Two querns S2810 and S2814, found in a layer (2054) east of the building, support the same conclusion. Furthermore, the wall thickness – less than in other architectural structures ascribed to this phase – as well as the fact that it was truncated by a later tomb, dated to the following phase G2, also rather speaks against the use as a communal cult place. An association with an individual tomb has also not been recognisable so far.

The layer (2032) above wall [2034] as well as its continuation to the east (2043 and 2064) contains typical rounded grinders S2772, S2791, S2842 and S2845, bearing traces of use; it is probable, that another domestic/industrial structure could be nearby. Notwithstanding, at this point, most of the architectural structures datable into the G3 phase are concentrated in Area 7 further to the south. Here, a new phase is marked by the thickening of certain walls known from a previous phase, followed by the building of short ½ brick thick walls.

1.2. Cemetery (phase G3–G2, Area 4)

The tombs of the cemetery in Area 4 are somewhat younger than G3 SIP settlement remains from Area 4, however, the tombs were part of the larger SIP cemetery in Areas 4, 7 and 9, where the whole pattern of occupancy and burying has not been settled yet.

¹⁹ The term ‘grinder’ denotes either a more or less well-rounded stone tool or a small stone tool of irregular shape usually with flattened side(s), made in most cases of flint or quartzite. These objects were probably multifunctional tools used for grinding or hammering, possibly also for other activities. For identification as a hammer, see PRELL 2011, 36.

²⁰ Based on macroscopic observations, it seems that bricks of different composition were used in the construction of the tomb. The majority of the bricks used were the usual light greenish grey bricks (30×17×8 cm and 33×17×6 cm). However, pale yellow sandy bricks (22×11 cm) were used as well, mostly in the vault construction, but occasionally also in the chamber walls. Beyond that, there seems to be no concrete pattern in laying these bricks – it looks like the builders of the tomb used whatever was currently at hand. It is, therefore, not clear, if the use of different bricks

1.2.1. Mudbrick tomb [2009]

About 45 cm south of wall [2045], a relatively large mudbrick tomb with a vaulted roof is located (see Fig. 2). It is younger than wall [2045] because the burial pit <2010> was dug into a layer that covered this wall. It is not possible to estimate how long after the architecture to which wall [2045] once belonged to ceased to be in use as the tomb was built, as the top edge of the burial pit could not be established with certainty.

1.2.1.1. Architecture (Fig. 5)

The SE-NW oriented tomb [2009] was built in a relatively narrow rectangular burial pit <2010> with rounded corners. The tomb pit was dug into a natural reddish sandy gravel layer (2049). The tomb structure almost completely filled the pit; the rectangular burial chamber has internal dimensions of 130×56 cm. Its walls are one brick thick and three rows high, built in an irregular bond of alternating stretchers and headers, with sporadic alternations of yellowish and greyish mudbricks.²⁰



Fig. 5 Mud-brick tomb [2009] (photo K. Smoláriková)

is a technological and chronological distinction, like for example in Tell el-Dab'a (where, interestingly, what seems like a different pattern of use of sandy bricks was observed – during the 13th Dynasty, the sandy bricks were used for the construction of burial chambers and mudbricks were employed occasionally in vault constructions. During the 15th Dynasty, the sandy bricks gradually became replaced by mudbricks even in the chamber structure). See FORSTNER-MÜLLER 2008, 27. However, it is also possible that the use of different coloured bricks is just a random outcome of an unintentional use of slightly different material sources for brick production.

The vault was built directly on the burial chamber walls. This construction corresponds to Tell el-Dab'a type 4.²¹

On the long sides of the vault, bricks placed on edge were laid in alternating rows to prevent alignment of vertical joints within the vault, thus giving the whole structure more stability. The vault was further stabilised by a relatively thick covering layer of bonding material. The top of the vault seems to be missing, at least in the southern part – this may be a result of tomb robbery, but also of the possible placement of a secondary interment in the chamber. No entrance pit was observed, however, the southern part of the tomb was not excavated completely from outside (it was covered by the southern wall of Black House 1).

1.2.1.2. Contents of the tomb

Multiple burials seem to be interred into the tomb.²² However, their situation is not entirely clear because of the state of the skeletal remains described below. Relatively high in the burial chamber, in a fine loose filling of the tomb (2016), a human skull and pelvis bones (2017) were found on one heap. After documentation and removal of these bones, another interment was found deeper in the burial chamber. This more or less complete skeleton (2019) seems to belong to the initial tomb-owner. It lay in the northern part of the burial chamber, divided by a brick from animal bones in the southern part. However, the bones of this



Fig. 6 Skeleton (2019) in tomb [2009] (photo L. Hulková)

individual, although filling the whole northern part of the burial chamber, were not found in an anatomic position. Instead, the bones make the impression of being displaced, partially with respect to their original anatomic position – the arms were found together under the skull in the south, while the legs were placed together further north (Fig. 6). This seems to speak against tomb robbery because skeletons of other robbed tombs from Tell el-Retaba were found in much larger disarray.²³ Further, also the find of a bronze dagger S2722 with limestone pommel S2720, found together with pelvis bones, seems to speak contra to robbery.

Such a situation is unparalleled in Tell el-Retaba so far. The sole instance of a roughly simultaneous interment of two individuals in one tomb is known²⁴ and two cases where an older interment was rather carelessly swept away to make place for a new one were documented.²⁵ However, in these cases complete second skeletons were in anatomic positions, at about the same level as the original tomb-owner used to be.

1.2.1.3. Small finds

1.2.1.3.1. Pommel S2720 (Fig. 7)



Fig. 7 Dagger pommel S2720 from tomb [2009] (photo L. Hulková)

Material: limestone

Dimensions: max. Ø: 4.0 cm; base Ø: 2.4 cm; height: 2.5 cm;

Socket Ø 1.16 cm; depth: 1.14 cm;

Transverse perforation Ø: 0.35 cm

²¹ FORSTNER-MÜLLER 2008, 29–30.

²² Anthropological evaluation of the skeletal remains of season 2016 are still pending; therefore, no detailed analyses can be given here.

²³ RZEPKA *et al.* 2014, 44–45.

²⁴ NOUR EL-DIN *et al.* 2016, 82.

²⁵ RZEPKA *et al.* 2014, 41–42; NOUR EL-DIN *et al.* 2016, 99.

Description: sub-globular pommel made of whitish limestone originally placed at the top of the (now disintegrated) grip of the dagger S1922 found in the same tomb. Insofar an unrestored state, it is not possible to say if the pommel was polished, like some of the known parallels.²⁶ The pommel has a concave upper part and a flattened base. At the base a round socket was used to connect the pommel with the grip. To fix the pommel more firmly, two small peg holes were drilled from the lower side of the pommel, perpendicular to the hilt hole. These holes were placed roughly opposite each other, but they are not completely aligned. No traces of these pegs are preserved – probably they were also not made of metal.

State of preservation: well preserved, surface sintered

1.2.1.3.2. Dagger S2722 (Fig. 8)

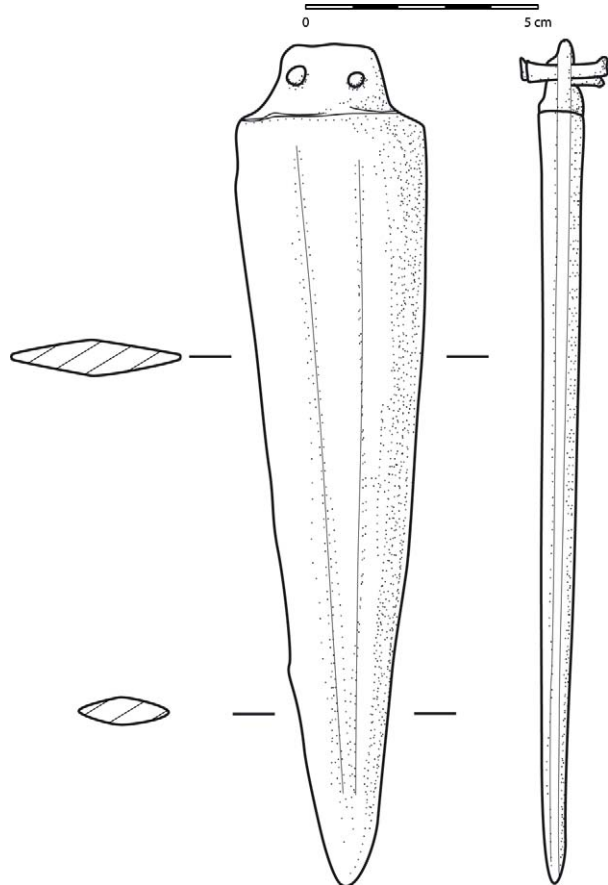

Fig. 8 Dagger S2722 from tomb [2009]
(drawing: R. Knápek/L. Hulková)

Material: Copper alloy

Dimensions: Max. length: 18.1 cm;

Blade length: 16.5 cm; max. width: 4.05 cm; height: 1.0 cm,

Rivet length: 1.66 cm; Ø: 0.3 cm

Description: No exact detail of the blade form or production technology can be given before further cleaning and restoration. However, based on the overall shape of the blade, it seems to belong to the category of styled daggers with undecorated blades.²⁷ In the trapezoidal tang, two rivets are preserved. Other than at the most known examples,²⁸ they are arranged horizontally and not above each other. The line visible between the tang and the blade probably delineates the lower end of a former hilt.

State of preservation: complete, strongly corroded

1.2.2. Mudbrick tomb [2057]

Another mudbrick tomb [2057], somewhat smaller than tomb [2009], was found in the eastern part of the excavated area, about 60 cm east of wall [2065]. The bottom of its burial pit was also sunk into a natural reddish gravel layer and seems to be slightly younger than structure [2065].

1.2.2.1. Architecture (Fig. 9)

The ENE-WSW oriented tomb [2057] was built in a narrow rectangular tomb pit <2052> with rounded corners. The small trapezoidal burial chamber with internal dimensions 99×38–58 cm was built of two rows of rectangular mudbricks (39×16×10 cm) in stretcher bond. The eastern gable was probably built separately because the bricks are not bound with the rest of the chamber structure and go beyond the eastern limit of the north-



Fig. 9 Mud-brick tomb [2057] (photo V. Dubcová)

²⁶ PHILIP 2006, 56–58.

²⁷ PHILIP 2006, 47–52.

²⁸ PHILIP 2006, 48, fig. 15, 49 or fig. 16, No. 4139.

ern and southern chamber walls. Apart from the eastern gable, the walls of this tomb are only $\frac{1}{2}$ brick thick.

The roof construction was built directly above the walls of the burial chamber. The gabled roof consists of pairs of sloping mud bricks propped against each other. The roof construction was backed against the eastern gable and was covered in a thick layer of bonding material that also filled the spaces between the burial chamber walls and the roof. This certainly provided more stability for the roof, and possibly also created a semblance of a barrel vault. In the east there is one brick laid atop of the roof, connecting it to the gable. Apart from the trapezoid form of the burial chamber, this tomb corresponds to type 3.1 of Tell el-Dab^a.²⁹



Fig. 10 A young individual (2059) buried in tomb [2057] (photo V. Dubcová)



Fig. 11 Pottery cup from tomb [2057] (photo T. Kmet')

1.2.2.2. Contents of the tomb

A young individual (2059) was buried in the burial chamber (Fig. 10). The body was placed in a semi-contracted position on its right side, with the skull in the east, facing north. The arms were slightly bent at the elbows and placed in front of the body. The contracted legs lay above each other. By the head of the burial, in the NE corner of the burial chamber, a pottery cup (Fig. 11) was placed at the same height as the interment.

1.2.3. Mudbrick tomb [1696]

The large mudbrick tomb [1696] was heavily destroyed by recent construction works because it is located at the north-western outskirts excavated in Area 4, in very close proximity to a modern sewage pit. Its north-eastern corner was discovered at the end of the 2011 season.³⁰ The damaged remains of the tomb were partly excavated from inside and from the western and northern side in the 2015 season. The outer side of its eastern wall was partly unearthed (about in the middle of the wall) in the 2016 season.

1.2.3.1. Architecture (Fig. 12)

The SE-NW oriented tomb once consisted of a rectangular burial chamber with the inner dimensions 90×190×70 cm. It seems to have been built in a narrow tomb-pit, however, its precise form or dimensions could not be established due to the heavy damage the structure suffered recently. The NW corner of the structure is missing completely, and the western and northern walls are heavily damaged and soaked by the water from the sewage pit. Based on the observations on the better preserved eastern wall, the chamber walls were one brick thick. The long walls consisted of six rows of mud bricks (34×18×12 cm) in stretcher bond. The southern gable was built in header bond, apart from the 1st and 4th row (counted from the bottom), which are in stretcher bond as well. On the inside of the eastern and western walls the rest of the mud mortar, once probably covering all walls of the burial chamber, can be seen.

Above the walls of the burial chamber, a mud brick vault was constructed. The lowest part of the vault is preserved over a part of the eastern wall. It

²⁹ FORSTNER-MÜLLER 2008, 28.

³⁰ RZEPKA *et al.* 2014a, 55, Fig. 28.



Fig. 12 Mud-brick tomb [1696=1757] (photo K. Smoláriková)

seems that this vault was never completely covered by earth, as there were ashy layers discovered coming directly towards the vault/gable at least from the eastern and southern side. The upper part of the vault was already destroyed in antiquity. An ashy layer associated with the Green House was observed above the vault bricks (cf. below).

The eastern edge of the burial pit of tomb [1696] cuts the older wall [2034]. The distance between the pit and the external face of the eastern tomb wall is narrow, about 11 cm. It seems, that the builders pushed the basic (stretcher) row of mudbricks to the lower edge of the burial pit, at least at the eastern side of the pit (Fig. 13). The next header bond row of mudbricks was seen as the first one from the inside of the tomb (Fig. 14). It seems that the burial chamber was built in such a way that the builders worked from the inside of the chamber. The self-supporting³¹ vault might



Fig. 13 Outer side of eastern wall [1696=1757] (photo J. Hudec)



Fig. 14 Inside of tomb [1696=1757], looking eastward (photo K. Smoláriková)

have been constructed only after the interment. The older SIP architecture [2034] was apparently out of use by the time, since wall [2034] was already covered by a sandy layer (2032), into which the tomb pit was cut, disturbing wall [2034].

1.2.3.2. Contents of the tomb

In the tomb, a largely disintegrated skeleton of a child (1699) was discovered. Together with this burial, faience beads S2188 were discovered. The anthropological analysis has shown that a further two individuals were buried here, one of them adult, the other juvenile.

The dimensions of the tomb also suit an adult interment better, the child being only an intrusive secondary burial or part of a family burial. Due to the condition of the tomb, the excavations were not able to determine how the secondary interments were inserted into the chamber. The synchronic layer adjacent to the gable (covered by an ashy

³¹ An observation of construction engineer Miroslav Černý.

layer) and the gable itself seem to be intact, thus the interment through the dismantled vault seems to be rather probable.

By the south-eastern corner of the burial chamber, about 5 cm from the bottom of the tomb, a bronze spear head S2191 was discovered. It probably belonged to the original tomb owner and was either overlooked when the tomb was looted, or left in place when the original burial was swept away to make place for a new one. Also, within the tomb fill a pottery sherd S2192 with scratched decoration was found. It is not clear, if it was placed in the tomb intentionally.

1.2.3.2.1. Skeleton 1699 (=1757/2)

Preservation: Fragments of child skeleton.

Morphological characteristics: Gracile skeleton with a weak MR. The fragment of the front mandible part, lumbar vertebra with a not conjoined arc to the body, not conjoined *os pubis dx.* (length of *os pubis* = 34 mm), two phalanges without proximal epiphysis, each 19 mm long. Present isolated right-sided baby teeth c (83) and m2 (85) with uncapped roots and impacted the permanent upper right *incisivus* first (11) and the lower left first *incisivus* (31).

Conclusion: Child, age 3–5 years (infans I).

1.2.3.2.2. Skeleton 1757/1

Preservation: The postcranial skeleton fragments of an adult.

Morphological characteristics: The robust remains with bigger muscular relief (MR). Fragments of vertebrae (*processi spinosi*), better preserved *vertebra lumbalis*, which has on *processus articularis superior* osteophytes, on the cranial surface Schmorl's nodes indication, the caudal surface is damaged.

From pelvic bones are preserved: damaged *acetabulum dx.* with signs of osteophytes, damaged *os pubis dx.*, fragment of *os ischii* by *incisura ischiadica major*, *spina ischiadica* flat angular with a tip (male character). Present parts of tibial diaphyses with a median cross section of the V-type.

Furthermore, present: a fragment of *calcaneus*, caudal part with *tuber calcanei sin.* (?), proximal *phalanx 1 dx.*, carpal bone *capitatum sin.*, tarsal bone *cuboideum sin.*

Variations and pathological changes: Osteophytes and Schmorl's nodes occur on the preserved lumbar vertebrae (degenerative changes). Also, signs of osteophytes on the pelvic *acetabulum dx.*

Conclusion: The morphology of the bones seems to indicate an adult man.

1.2.3.2.3. Skeleton 1757/3

Preservation: Skeleton fragments of a juvenile individual.

Morphological characteristics: Fragments of gracile to medium robust *calvarium*, with mild muscular relief (MR): *os frontale*, *os temporale dx.* and *sin.*, *os zygomaticum dx.* and *sin.*, *maxilla anterior* with some teeth. *Norma frontalis: tubera frontalia* indistinct, *margo supraorbitalis* slightly rounded, orbits slightly angled, *fossae caninae* shallow, *sutura metopica* obliterated. *Norma lateralis: spina nasalis anterior* apparent, *os zygomaticum dx.* and *sin.* high with a more smoothed surface, *processus retromarginalis* relatively large.

There are individual teeth from the upper jaw (bilateral C, P1, P2, M1, M2, M3) having a 1st tooth abrasion degree (worn tips). M2 have roots almost closed and M3 have them developed about half.

At least two gracile fragments of ribs with not conjoined epiphysis to *extremities sterni*. Damage to fragmented three thoracic and one lumbar vertebra. Two thoracic vertebrae have holes in the body that are connected to each other (Fig. 15). One measuring 15×9 mm, and a second 16×8 mm (likely from animals).

A preserved damaged gracile to moderately robust *clavicula sin.* with weak MR has moderately curvature and non-adherent epiphysis on *facies articularis sternalis*.

Present non-adherent proximal epiphyses of left and right arm bones, some metacarpals with non-adherent proximal and distal epiphyses, a fragment of *os ilium* with *incisura ischiadica*



Fig. 15 Individual 1757/3, man, juvenis (15 years ± 36 months), holes in the body of thoracic vertebrae, caused by animals? (photo A. Šefčáková)

major, which is more closed, *caput femoris sin.* with adherent-in progress epiphysis (vertical diameter 44 mm).

Conclusion: The morphology of the bones and the adhesion/fusing of the epiphysis on the long bones seems to indicate a boy, at the time of death in the juvenis age group (15 years ± 36 months).

1.2.3.2.4. Beads S2188 (Fig. 16)



Fig. 16 Beads S2188 from tomb [1696=1757]
(photo R. Rábeková)

Material: Frit (Egyptian faience)

Dimensions: Ø: 0.25 cm; Ø of a thread hole: 0.1 cm; h.: 0.1 cm

Description: Twenty-four small circular beads made of bluish faience.

State of preservation: Few beads are broken, surface is weathered.

1.2.3.2.5. Spear head S2191 (Fig. 17)

Material: Copper alloy

Dimensions: length: 9.7 cm;

Blade: length: 4.4 cm; width: 1.82 cm; max. height: 1.6 cm;

Shaft length: 5.3 cm; width: 0.8–1.7 cm

Description: A small socketed spear head with a leaf-shaped sharp pointed blade, corresponding to Philip's type 7.³² The blade's cross-section is of a concave lozenge shape. The socket has an oval cross-section. It was not cast in form, but rolled around the wooden shaft and additionally fixed by a cross-nail driven through the socket wall that is still preserved in the socket. The nail probably did not go through the whole shaft. There might be an

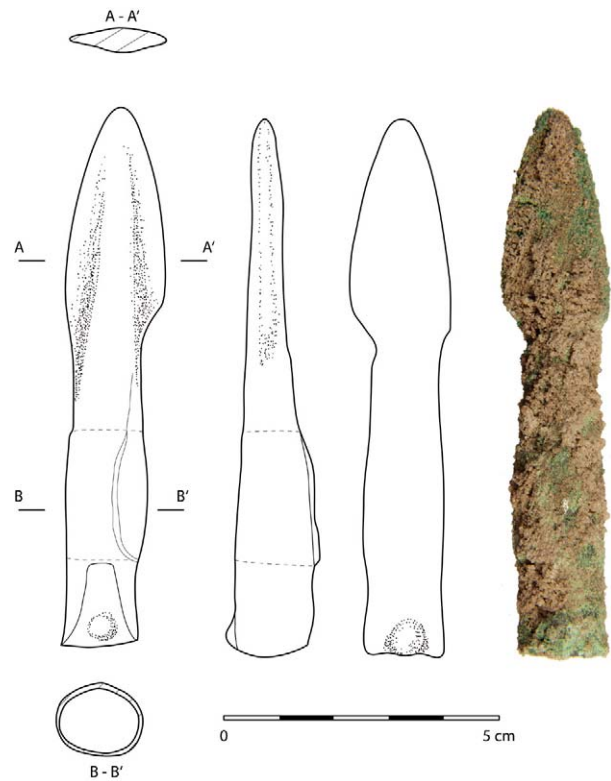

Fig. 17 Spearhead S2191 from tomb [1696=1757]
(drawing L. Kováčik, photo R. Rábeková)

additional metal binding ring on the socket, but it is necessary to restore the spear head before any further details can be recognised.

State of preservation: almost complete – only a small part of the shaft seems to be broken off, heavily corroded. Traces of wood were found inside the socket.

1.2.3.2.6. Pottery sherd S2192 (Fig. 18)



Fig. 18 Sherd S2192 with potter's mark, tomb [1696=1757]
(photo R. Rábeková)

³² PHILIP 1989, 94, 362.

Material: Nile clay

Dimensions: length: 6.4 cm; width: 5.1 cm; height: 0.8 cm

Description: Pottery sherd broken off a pottery vessel, irregular hexagonal in shape with a scratched pre-firing (?) potter mark.

State of preservation: Well preserved

1.3. Later open settlement (phase G2, Areas 4 and 7)

Phase G2 in area 7 is indicated by the thickening of certain walls known from a previous phase, indicating that some changes in the settlement activities took place – some rooms may have been abandoned, but the general outlay of the settlement seems to be unchanged, as the orientation of architectures of phase G2 follows the previous phase. The remains of the later settlement are generally badly preserved, when compared to the remains of Phase G3. Therefore, only a fragmentary picture of settlement activity can be drawn. The overhang of phase G2 to an even younger stage (G1?) can also not be excluded at the given state of knowledge. Due to the spatial distance between Areas 7 and 4, and a missing stratigraphic link, it is difficult to apply the phases to remains from Area 4, where no thickening of walls was observed. It seems, that during the later phase G2, the excavated part of Area 4 was used only as a cemetery.

1.3.1. The Eastern House in Area 7 – walls [1375] / [1437]

The remains of the younger phase of the Eastern House were already presented in a previous report.³³

After both walls [1375] and [1437] were removed, very thin layers separating them from walls of a previous phase were discovered. In these layers (1720=1732) an exceptionally large number of querns S2124, S2137, S2151, S2156, S2158, S2159, S2175 and grinders S2144, S2153, S2154, S2160, S2162, S2173, with one flint tool S2174 were found. These tools were probably used during or before the construction of the new walls and when they were not needed any more, they were discarded in the foundations of new walls.

1.3.2. The Western House in Area 7 – wall [1391]

The continuation of wall [1391] could not be traced further west in square Y95-X115. Only two structures dating to this phase were preserved in this square. One of them is a floor like-structure (1743) where two querns (S2176, S2186) were found, pointing towards domestic/industrial activities performed in this room. The other is a ½ brick thick wall [1742], similar to structure [1409].

1.3.3. Other structures

Phase G2 remains were also discovered in square Y105-X105, however, they could not be excavated due to time shortage. Two ½ brick thick walls [1750] made of yellowish mudbricks, similar to wall [1742], can be dated into this phase. Their relationship to tomb [922] cannot be inferred with certainty at the present state, but the tomb seems to be older than these walls. Here, further excavation is needed to be able to interpret these finds.

Ashy layer (1744), situated under Black House 3 can only be dated to the general phase G at this point, because it is not associated with any excavated architecture structure. However, finds of a metal fragment S2187 and a slag S2197 indicate that the production of metal objects was taking place in this area of the tell during the SIP.

2. 18th Dynasty settlement [phase F]

Important data about the 18th Dynasty settlement were collected from the further excavation of structures which were already known from the previous seasons or were newly uncovered in 2015 and 2016.

2.1. Earlier 18th Dynasty [phase F4, Area 4]

VD, JH

2.1.1. Green House (Fig. 2)

Whereas the 18th Dynasty F3 phase's structures in Area 7 lay right above the Second Intermediate Period level, there is an earlier 18th Dynasty phase F4 attested in Area 4, represented by a building made of greenish mudbricks, the so called Green House [700/2033/2037], unearched to some extent already in 2011.³⁴

³³ RZEPKA *et al.* 2015, 100–102.

³⁴ RZEPKA *et al.* 2014, 55, 60: the yellow mudbricks turned out to be a part of the SIP tomb SU 1696.

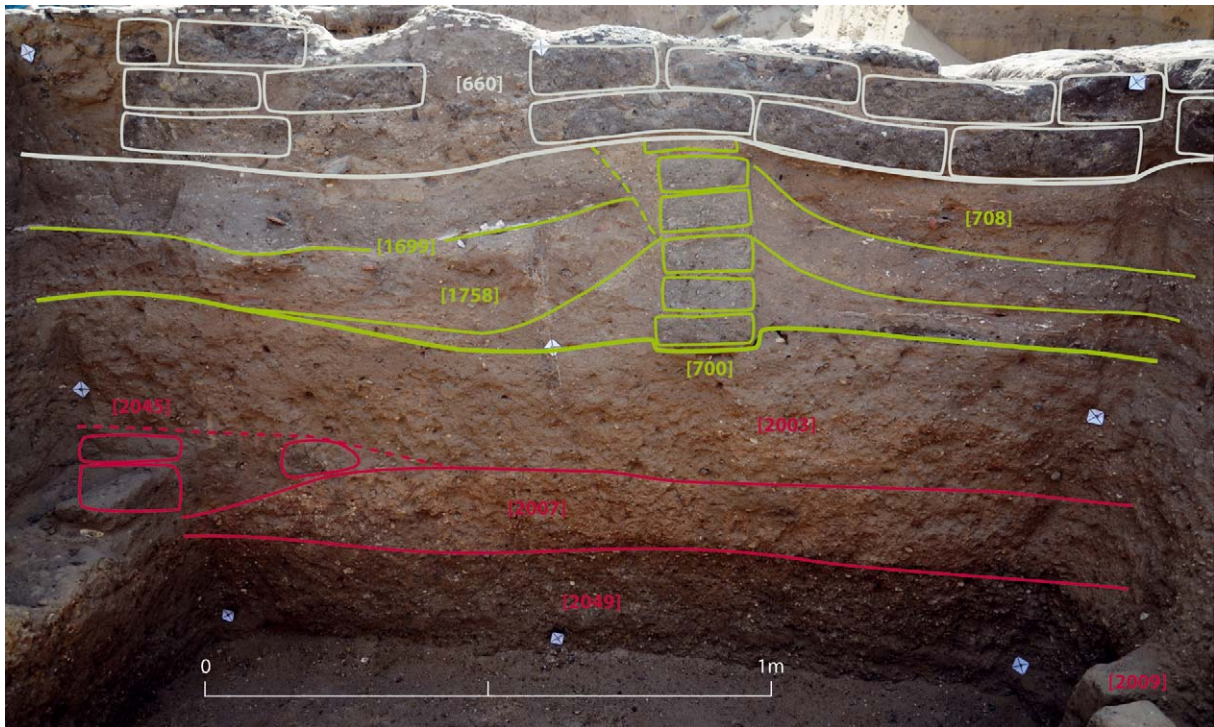

Fig. 19 Section underneath the eastern wall of room 2 of the Black House (photo V. Dubcová, spatial data and scaling of the photo E. Stopková, drawing L. Hulková)

2.1.1.1. Architecture

The structure was also truncated on its western side by the sewage and a recent pit, as was the case of Black House 1. The eastern extent of the Green House has not been specified yet; it might be either covered underneath the northern Migdol tower, or demolished during the Migdol and/or defence wall (Petrie's Wall 2) construction. The house with approximate dimensions 7 m in east-west direction and 6.6 m in north-south direction was of similar size as the above lying Black House 1, however, its N-S axis was oriented more eastwards (see Fig. 2). At least four rooms were constructed of 1 brick thick walls, preserved to a maximal height of five brick rows.

2.1.1.2. Stratigraphy

It seems likely that there were at least two levels of the Green House occupation in the frames of the F4 phase. The levels are most spectacularly visible in the section underneath the eastern wall of room 2 of Black House 1 (Fig. 19). The most distinctive marker is thin, but an evident layer of a white sub-

stance, which seems to be inside the house. A layer rich in animal bones was found southwards in 2011, below and beside a shallow depression filled with fine yellow sand (underneath Black House's room 2 and its outer wall). Moreover, an extensive fireplace (ash concentration) underneath Black House's room 1 (2018, 2026) seems to be atop of (later than?) the Green House, but predating Black House 1.

The younger occupation layer (above the white substance) contained several broken vessels and an alabaster kohl pot (Fig. 24), discovered along internal walls. It resembles a destruction or calamity horizon, despite that the earlier transition from the Second Intermediate Period to the New Kingdom in Area 4 seems to indicate a rather peaceful process without destruction horizons. The older occupation layers of the Green House are less ashy, containing more sand and gravel. Their consistence (mainly 1698, 1699, 1758, 1760, 2021, 2027, 2028, 2044, 2053, 2058)³⁵ seems to be alike the earlier SIP layers.

The situation in the area indicates that the Green House was not built on a strictly horizontal base. At least on the north-western side of the

³⁵ Layers from 2011: (694, 706, 707, 711).

Green House [2008], the architecture had been cut by the northern wall of Black House 1. The walls of the Green House were preserved on a higher level here; surveying confirmed a slight sloping of the Green House northwards (maybe also due to the obstructing vault of tomb [1696=1757] in the north-western part of the house?). As the younger building was cut into the older building, the external older layers of the Green House could be here on the same level as the internal fill of the younger layers of Black House 1.

The area to the north of the Green House with many traces of domestic and industrial activities could have been used as a kind of semi-permanent room or a kind of roofed patio, since several wooden stakes that might have supported a light roof were found here (Fig. 2). The stakes were parallel to the northern wall of the Green House, which supports their relation to this architecture.

So far, it has not been possible to estimate the length of time span between the decline of the SIP settlement (and/or cemetery) and the settlement of the Green House horizon. It seems that at least two different strata covered the ash layer on the basis of the originally exposed vault of the mudbrick tomb [1696=1757]. However, the strata were probably subtly cut/levelled, as well as the vault, during the construction of the Green House. The situation should be clarified here by further research, especially in respect to relations between the Green House and the SIP cemetery (especially tomb [1696=1757]). The younger occupation level of the Green House covered the vault of the tomb. Being probably exposed during the older occupancy of the Green house, the vault seems to be covered during the younger occupation level. So far, all the tombs discovered in the area, except for tomb [1696=1757], seem to be overbuilt by the Green House. The possible reasons for the vault staying exposed for some time may be a terrain characteristic (as the tomb seems to be high on the aggradation mound) or the result of the chronological development (the cemetery was probably used during the whole SIP occupancy).³⁶ The building activities within the area of the Second Intermediate Period cemetery and the settlement indicates

that the knowledge of the previous occupation levels by the time of the Black House usage was rather absent. Concentration of intensive building activity in this area, however, might testify to its importance within the site, probably due to its strategic position on a communication link towards west/north-west (adjacent to the future entrances to the Ramesside fortresses) and/or due to the dry position atop of the aggradation mound.

2.1.1.3. Small finds

A number of **flint tools** (S2760, S2767, S2773, S2811, S2823, S2836) and two **querns** (S2700, S2828) were found in the Green House.

Three pieces of **pigments** can be attributed to the older phase F4 of the Green House S2732 (2028), S2738 (2021), S2748 (2044).³⁷ Lumps of red ochre of diverse shape were found, with some of them obviously being shaped during abrasion or grinding (seven pieces; the largest ones ranging in weight up to 250g). Some pieces of mica were found as well in the Green House (706, 711).

A **kohl stick** S2809 from (2044) (Fig. 20) as well as different tools such as a **chisel** S2177 from (1699) and a **small knife blade** S2820 (2050) were found within the Green House. The **knife blade** S2820 (Fig. 21), broken into three pieces, can be attributed to the small single-edged knives with curved blades of Type 2 as defined by G. Philip,³⁸ representing probably a miniature version of big-

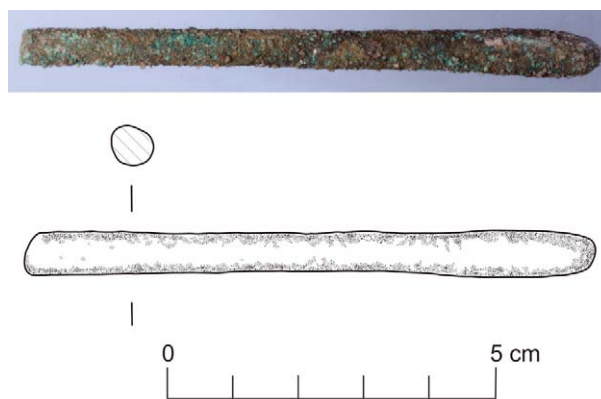

Fig. 20 Kohl stick S2809, Green House (photo Hulková, drawing R. Knápek)

³⁶ If the tomb was not fully sunken into the ground, the questions could be risen about smell evaporation in case of a busy settlement around.

³⁷ Two lumps of ochre can be attributing to an older SIP period (see above): S2746 (2042), S2749 (2007), indicating an even older tradition of processing this material on the site.

³⁸ PHILIP 2006, 78–79, fig. 35: esp. no. 3 (1746). See similar items also from Lahun: UC7535: PETRIE 1917, pl. XXV, nos. 77, 78, 98; GIDDY 1999, pl. 37:1400.

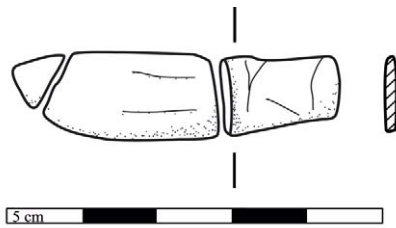

Fig. 21 Knife blade S2820, Green House (drawing R. Knápek)

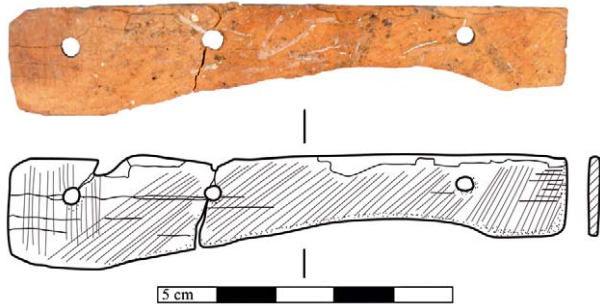

Fig. 22 Bone plaque S2801, Green House (photo T. Kmet, drawing R. Knápek)

ger knives (for cosmetic-hygienic purposes?). The **bone plaque** S2801 (Fig. 22), found in (2050), could be interpreted as a casing of a knife's handle. Similar kinds of plaques were used mainly during the SIP and are known e.g. from Qau³⁹ or Tell el-Maskhuta.⁴⁰ From other discovered objects, two scarabs from the Green House (underneath room 2 of Black House 1) are of importance.

Scarab S2193 (1760) has a slightly irregular shape and a damaged undecorated base (about half of it is missing). Its back is worn and highly schematic, without traces of separation lines. One circular line runs around the thickness of the amulet. The scarab is made of beige frit (Egyptian faience) with traces of creamy glaze; it is longitudinally pierced for threading. Dimensions: length 10 mm, width 7 mm, thickness 6 mm.

Complete oval shaped **scarab S2183** (1758) made from creamy frit (Egyptian faience) with traces of creamy/beige glaze; it has a flat base with a deeply incised oval border surrounding a simple *nfr*-sign or a *sm3*-sign (Fig. 23).⁴¹ Its back is highly schematic and worn; the clypeus and head are out-

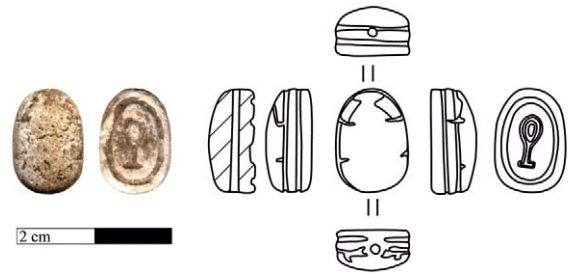

Fig. 23 Scarab S2183, Green House (photo R. Rábeková, drawing L. Kováčik)

lined; prothorax and elytra are separated just by a very short line on each side. No internal details. Legs are indicated by two circular lines around the thickness of the amulet. It is longitudinally pierced for threading. Dimensions: length 13 mm, width 9 mm, thickness 6 mm. The scarab could be attributed to the design group 3A3 – *Varia* with Egyptian signs and symbols or 3A1 (*sm3 t3wy*).⁴² Being mostly of Canaanite origin and locally produced, designs of these scarabs consist of signs imitating Egyptian hieroglyphs and belong to the early as well as the late Palestinian series.⁴³

2.2. Mid 18th Dynasty [phase F2 and F3, Areas 4 and 7]

VD, JH

The later phase of the 18th Dynasty is represented by a series of buildings constructed from blackish mudbricks, the so called Black Houses and related installations. These structures were covered by the defence wall of the 20th Dynasty fortress (Petrie's Wall 2) and the northern tower of Migdol.

2.2.1. Black House 1 (Fig. 2)

To be able to excavate the full area of Black House 1, unearthed partly in 2011 and 2014 in Area 4 [660/1695],⁴⁴ further parts of the mudbrick platform [1675] were removed. The discovered part of Black House 1 was sealed below the mudbrick destruction (1691).

A certain time difference between the decline of the Green House and the construction of Black

³⁹ From Qau see nos. UC26309, UC26310.

⁴⁰ REDMOUNT 1989, 242–243, fig. 45:2-3.

⁴¹ Identical piece from Tell el-Ajjul, 15th Dynasty in KEEL 1997, 486–487, no. 1119; another but without the outline line: NEWBERRY 1907, 309, pl. XVI: 37231: dated to 18th Dynasty/Hatshepsut.

⁴² TUFNELL 1984, Vol. I, 272–275, pl. 8b, 1365; Vol. II, 117–118; BEN-TOR 2007, 75f, 126, pl. 7, 51, 77.

⁴³ BEN-TOR 2007, 126, 160.

⁴⁴ RZEPKA *et. al.* 2014, 56–64.



Fig. 24 Alabaster kohl-pot, Green House (photo L. Hulková, drawing R. Knápek)

House 1 is indicated by the obvious changes in the settlement structure and organisation, demonstrated by the different orientation of both buildings. The houses, nevertheless, were not separated by a long period, as is suggested by similar ceramic material and by the fact that the walls of the Green House were still preserved at a considerable height.

2.2.1.1. Architecture

With its western part truncated by a recent sewage pit and by a rectangular pit, the dimensions of the house are c. 7.49 m (N-S) x 7.40 +x m (E-W). As is visible in the eastern section below Black House's room 2 (Fig. 19), the first row of bricks of Black House 1 walls stands almost directly on the walls of the Green House. It seems that the construction area of the Black House was not even consequently levelled out and the walls of the Green House were at least partly incorporated in the construction of Black House 1.

The filling layers and underlying structures of three small rooms to the south (1–3) of Black House 1 lining one big room to the north (room 4) were excavated. The house consisted of one brick thick walls, preserved mostly in 2–4 rows, with rooms 2 and 3 being separated by a thin $\frac{1}{2}$ brick wall. The interruptions within the walls on the southern and eastern sides could indicate possible entrances. An entrance from the north, in the north-eastern corner of the house, might also be

plausible, as indicated by a $\frac{1}{2}$ brick reinforcement, probably forming a pillar (cf. Fig. 2).

2.2.1.2. Stratigraphy

The original floor consisting of yellow mudbricks was preserved in some places within rooms 1 and 4, with two visible post holes in the centre of room 1, (1998), (2011). The main occupation phase was represented by several ashy-sandy layers with black, white and grey burnt places (1688), (1690), (1997), (2001) (partly mixed with collapsed walls that are probably the result of levelling the surface during the construction of the Ramesside fortification), (2012), (2051).⁴⁵

The numerous burnt places and ashy consistence of the layers filling the rooms of Black House 1 and its surroundings as well as the presence of related structures (ovens, silos) discovered in 2011 to the south and south-east from the house suggest diverse domestic activities and craft production that were undertaken by its inhabitants.⁴⁶

2.2.1.3. Small finds

Various possible activities could be indicated by the most frequent finds, which are the flint tools of diverse types, recovered in large number from Black House 1 and the northern (working or public?) area (S2707, S2730, S2742, S2761, S2792, S2798, S2793). The same is true for the great variety of other stone tools, above all different querns (S2703, S2745) or grinders (S2693, S2696, S2698) from Black House 1.⁴⁷

Metalworking is attested in the area north of Black House 1 (1993), with numerous metal fragments, slags and a fragment of a crucible containing traces of copper S2744.⁴⁸ Remarkable is the occurrence of complete metal objects ranging from the representative weapon (dagger S747)⁴⁹ to different sticks e.g. S2843 from (1993)⁵⁰, one kohl stick S2699 from (2001), toggle pin with a rolled head S2789 from (2048)⁵¹ from Black House 1 and its surroundings.

⁴⁵ To this phase were attributed also the units discovered in 2011: (682), (685), (688), (690), (694), (708) etc.

⁴⁶ Suggested also earlier in RZEPKA *et al.* 2014, 60–64.

⁴⁷ Some of them were already presented in RZEPKA *et al.* 2014, 60–64.

⁴⁸ Metallurgical activities at the 18th Dynasty settlement were attested also in Area 7 in 2014, see RZEPKA *et al.* 2015, 106; they can be assumed already for the time of the Second Intermediate Period, see above.

⁴⁹ RZEPKA *et al.* 2014, 62–64.

⁵⁰ Uncertain whether a kohl stick or some other needle, see similar pieces in ROTHENBERG and BACHMANN 1988, 151–153, fig. 58:15–21.

⁵¹ PHILIP 2006, fig. 46:14 (927), or maybe a kind of miscellaneous tool such as fig. 57:5 (4465): hand spindle? – in Daba'a from Str. c – G/1-3; also, ROTHENBERG and BACHMANN 1988, 157–158, fig. 62.



Fig. 25 Fragment of galena S2786 (photo L. Hulková)

Specialised craft production is proven by a considerable assemblage of discovered raw materials. Diverse pigments, such as red ochre, galena and antimony,⁵² occurred within the contexts of Black House 1's main usage phase (F3); four pieces of red ochre raw materials were found in the 2016 season: S2725 (1993), S2750 (2051), S2784, S2786 (2001). Some other pieces were already found in the year 2011.⁵³ Among other discovered minerals were three galena pieces (from previous seasons in layers (685) and (688)) and two pieces S2777 (Fig. 25) and S2797, found within Black House 1 in 2016. Eight pieces of mica, recovered from outside of Black House 1, together with S2741 (1993) and S2803 (2008) from room 1, were probably also used in craft production. Connected with the processing of these raw materials probably were also pieces of pumice, volcanic material of Mediterranean origin.⁵⁴

A damaged **amulet S2697** came to light from the floor of Black House 1 (layer 2001). Made from a blue frit (Egyptian faience), it has a bored hole at the top. Dimensions of the amulet: length 10 mm, width 8 mm thickness 3 mm. Due to its condition it could be only ambiguously interpreted, either as a bee pendant-amulet⁵⁵ or a fragment of an amulet in shape of the *pesesh-kef* tool.⁵⁶

⁵² Documented already in 2011, RZEPKA *et al.* 2014, 61; the composition of the materials has not been analysed yet.

⁵³ Five pieces in contexts of units (647), (690), cf. RZEPKA *et al.* 2014, 61.

⁵⁴ The exact origin of the pumice fragments (found also in Black House 3, S1822, phase F3) has not yet been designated and cannot be used for arguing in the ongoing chronology discussion. See more in FOSTER *et al.* 2009; STERBA *et al.* 2009.

⁵⁵ Similar pieces from Gurob (BRUNTON and ENGELBACH 1927, pl. XLII, 32); Hawara (ENGELBACH 1923, pl. LIV, 22); also in PETRIE 1914, pl. II: 19.

In the same layer (2001) a fragment of a convex bottom from a beige **faience vessel S2695** was found as well. The surface of the fragment is decorated with a geometric stripes pattern and a black floral internal decoration, probably representing papyrus buds, as common on the so-called fish bowls.⁵⁷

2.2.2. Black House 3

Some further architectural remains were discovered on the northern and western side of the previously excavated Black House 3⁵⁸ in Area 7. Some layers dated to the main occupation period of the house [F3] and part of a small wall (one row of bricks) running from the north-western corner of the house towards the north [1726] were documented. Room 2 of the house was excavated down to the natural ground.

2.2.2.1. Architecture (Fig.3)

One storage vessel (Fig. 26) was discovered right below the construction level of the western wall of Black House 3. The vessel (1703) might belong to Black House 3, being dug into the ground for storage purposes.⁵⁹ However, as the vessel was found



Fig. 26 Storage vessel underneath Black House 3 (photo V. Dubcová)

⁵⁶ MÜLLER-WINKLER 1987, 408f, pl. XXXVI:740.

⁵⁷ Compare the similar decoration on the 18th Dynasty faience bowl's fragment from Petrie's collection: UC45106, from Buhen UC 21153; for more examples, see SCHULMAN in: ROTHENBERG and BACHMANN 1988, 129–135, 308, fig. 42 – here 19th–20th Dynasty.

⁵⁸ RZEPKA *et al.* 2014, 56–64; 2015, 103–106.

⁵⁹ For vessels found in similar contexts, see WILSON 2011, 69, fig. 118.



Fig. 27 SIP layers underneath Black House 3
(photo V. Dubcová)

almost at the passage between two rooms of Black House 3 and its rim was (probably) removed to the foundation level of Black House 3, there are some doubts on its storage purpose. Although no older structure/architecture was found preserved, there is an older occupancy level, about 20–25 cm thick, underneath Black House 3, which has at least two stages – an older darker one (with content of ash) and a younger brown one (Fig. 27).

2.2.2.2. Stratigraphy

According to the northern section of the excavated wall of the building, there were more phases during its construction, since in one part there are only two rows of mudbricks instead of three as in the remaining wall, probably indicating an originally planned entrance (?). Because the rest of the house is covered by the later Ramesside fortification (Wall 2), it is not possible to further investigate its construction details. Some scattered 18th Dynasty layers (1712, 1730, 1737, 1738) came to light in squares to the south (Y105X105, Y115X110 and Y95X115).

Remains of a mudbrick structure, probably a wall or floor (only one row of mudbricks laid on the bed) [1736] of remarkable size are situated directly on the Second Intermediate Period wall [1766]. Their connection with the other structures and their function have yet to be clarified in the future.

2.3. Discussion on small finds and the function of the 18th Dynasty houses

The interpretation of finds suggests diverse domestic activities and craft production undertaken by inhabitants of the houses.⁶⁰ This assumption is further corroborated by a wide scale of items, being partly similar or related to each other in both the Black and the Green House and in the connected areas.

2.3.1. Pigments

Several pigments, either as powder or as raw materials, were found in the houses. Such pigments were widely used as painting materials, applied to diverse media from papyrus to wall paintings, as is confirmed mostly from the 18th Dynasty Amarna or Thebes.⁶¹

2.3.1.1. Red ochre, mostly haematite (Fe_2O_3 – iron oxide) or realgar (As_4S_4 – arsenic sulphide), constitutes the most common red pigment used in dynastic Egypt.⁶² Haematite was added into diverse small objects such as beads, pendants, kohl sticks or seals as well.⁶³ It is also assumed that it was applied in cosmetics production, either in the form of powder (face paint) or as a mixture with fat and oil for a kind of lip paint. The existence of lip paint is stated on the Turin ‘Erotic papyrus’ (pTurin 55001), depicting a woman painting her lips with a brush, whereas the face paint is clearly demonstrated by depictions of queen Nefertari in her tomb QV 66.⁶⁴ The Egyptian sources of haematite were sought within the area of Aswan, the oases of the Western Desert or the Red Sea area, realgar could have been imported from Asia Minor.⁶⁵

2.3.1.2. Galena (lead sulphide, PbS) is supposed to be one of the materials used for the production of kohl, eye paint, mostly together with brown ochre, lead carbonate, arsenic, malachite, chrysocolla and antimony.⁶⁶ The use of metallic antimony has been questioned and largely refused because of the very limited evidence and negative analyses.⁶⁷ Whereas materials such as malachite and galena were obtained in Sinai and the Eastern

⁶⁰ Suggested also earlier in RZEPKA *et al.* 2014, 60–64.

⁶¹ LEE and QUIRKE 2000, 114.

⁶² SCOTT 2016, 193; LEE and QUIRKE 2000, 113–114.

⁶³ LUCAS and HARRIS 1962, 346–347.

⁶⁴ LUCAS and HARRIS 1962, 84–85; SCHOSKE 1990, 26–27, also mentions rests of ointment containing ochre preserved in some cosmetic vessels (cat. nos. 145, 147).

⁶⁵ LUCAS and HARRIS 1962, 348; LEE and QUIRKE 2000, 114; realgar was found among the cargo on Ulu Burun, see MOOREY 1994, 328.

⁶⁶ LUCAS and HARRIS 1962, 81–82.

⁶⁷ LUCAS and HARRIS 1962, 195–199; OGDEN 2000.

Desert, and galena also probably in Aswan and on the Red Sea Coast, antimony does not occur in Egypt, but comes from western Asia.⁶⁸ Written sources mention that eye paint was obtained from the Asiatics in the 12th Dynasty and from Naharin and Punt from the 18th Dynasty onwards.⁶⁹

2.3.1.3. Mica, an aluminosilicate mineral appearing in many types (biotite, muscovite, phlogopite or lepidolite), was found in the Eastern Desert and at Wadi el-Hudi. From Prehistoric until Roman times it was occasionally used in Egypt for the manufacturing of beads, pendants, mirrors and vessels.⁷⁰

2.3.1.4. Pumice, distributed on many sites in Egypt and in the eastern Mediterranean, occurs in settlement as well as cemetery contexts. Whereas it was given to graves as a cosmetic equipment, when found in similar workshop areas, pumice was mostly used as an abrader or in the form of powder.⁷¹

2.3.1.5. Volcanic obsidian constituted material for the production of tools or diverse artistic implements (inlays, amulets, pendants, vessel or parts of other objects).⁷²

2.3.2. Interpretation of pigments concentration

The concentration of pigments in both houses is remarkable and could be interpreted in several ways. In connection with the position of Retaba at strategic paths leading to Sinai and Asia, it could indicate broader trading and local processing activities with diverse pigments.

Larger concentrations of pigments sometimes appear in domestic contexts,⁷³ however, mostly in artistic workshops. In Amarna⁷⁴ or Tell el-Dab^a⁷⁵

they were used e.g. for wall paintings, sculptures or the production of pottery and faience.⁷⁶ The production of such items⁷⁷ has so far not been explicitly confirmed at Tell el-Retaba in the early New Kingdom.

Red ochre could also have been used for the production of ink and for writing,⁷⁸ nevertheless, the discovered amount of pigment would suggest some specialised writing activities (administration, archives) which are also not attested. Red ochre, mica and obsidian were often used for the production of diverse amulets and although no finished objects were found, some beads and perforated shell pendants could indicate these kinds of activities.⁷⁹ Future study of the finds has promising potential to enlarge knowledge about their usage.

Since the production of textiles is also suggested by the find of a spinning bowl (S2804, from SU 2053, Green House)⁸⁰ and a loom weight (S761 from 690), the ochre fragments could also be used for textile dyeing.⁸¹

Nevertheless, the whole assemblage and above all the presence of galena and antimony suggest that the materials were used for the production of cosmetics. This assumption is also supported by the presence of many cosmetic containers and tools such as kohl pot S2779 from (2012) and kohl pot lid S769 (from 696 – outside of Black House 1), kohl tube S764 (from 705), kohl sticks or even the small knife blade (see above).

2.3.3. Occurrence of shells

Numerous shells, found in both houses on the site in the semi-desert Wadi Tumilat, could also have

⁶⁸ OGDEN 2000, 149.

⁶⁹ LUCAS and HARRIS 1962, 83–84.

⁷⁰ LUCAS and HARRIS 1962, 262–263; ASTON *et al.* 2000, 45.

⁷¹ Found in tombs, see FOSTER and BICHLER 2003; STERBA *et al.* 2009, 2739; in Sais: WILSON 2011, 98.

⁷² ASTON *et al.* 2000, 46–47.

⁷³ For example, from the Second Intermediate Period Tell el-Maskhuta: REDMOUNT 1989, 242.

⁷⁴ Amarna, Workmen's village: WEATHERHEAD and BUCKLEY 1989; WEATHERHEAD 1995; Main city, house of Ranefer and Grid 12: KEMP and STEVENS 2010, 533–544.

⁷⁵ JANKOVICH 2008, 253; Areal H/III, Werkstatt W1; JANOSI 2002.

⁷⁶ Sometimes they are found at settlements in smaller amounts: WILSON 2011, 99, pl. 3.

⁷⁷ No wall paintings were found, pottery production is not attested (no kilns found) and there are only a few faience fragments in this phase. However, layers of ash found in

the houses and especially in their economic background to the south-east, do not allow to exclude calculations with fire utilising craftsman activities, in particular because other specialised crafts could occupy other parts of the tell and the eventual contemporary temple has not been discovered so far.

⁷⁸ LEACH and TAIT 2000, 238–239.

⁷⁹ Diverse objects made of haematite or mica were found at Timna: KERTESZ in: ROTHENBERG and BACHMANN 1988, 209–211, 314, fig. 83.

⁸⁰ This type of vessel has its origin in Egypt (the oldest Middle Kingdom examples come from Abu Ghalib) and was widely used throughout the New Kingdom (a great assemblage from Amarna and Deir el Medina). It has a pair of interior handles with the process of spinning being depicted in tombs from Thebes (Meketra), Beni Hasan or Bersha: DOTHAN 1963.

⁸¹ VOGELSANG-EASTWOOD 2000, 278–279.



Fig. 28 Assemblage of snail shells, Green House (photo V. Dubcová)

been connected to the cosmetic production. The shells represent diverse species from both the sweet water molluscs and sea shells, originating in the Mediterranean or the Red Sea.⁸² While the sweet water snails and molluscs from the nearby lakes, canals and river were probably part of the common diet (S2740, 19 piece assemblage of snails from the Green House (2025), cf. Fig. 28), the sea shells probably served other purposes. As was the usual practice throughout the dynastic history, many of them were perforated and thus part of necklaces and personal ornaments.⁸³

2.3.3.1. Taxonomy of shells

The **mamilla-shells** (*Policines Mamilla*) (S2708, S2711 from 2001) and **cowrie-shells** (*Cypraea*) had an apotropaic function and were often connected to women and childbirth.⁸⁴ Of similar use were also other sea shells, e.g. **Conus minimus** (S2727) from Black House 1, and **Cerithium Erythraconense** from both, Black House 1 (S2762, S2763) and the Green House (S2122,



Fig. 29 Pearl oyster S2184, Tridacnidae family (photo L. Hulková)

S2795), or the **cockle-shells** (*Cerastoderma* or *Acanthocardia*) found by the cleaning of Petrie's Wall 2 (S2733).⁸⁵

Bigger **murex-shells** (*Murex trunculus?*) S2756 (2027) and S2152 (1691) were found in the Green House and could also have been used for the production of white powder (calcite?) for painting or cosmetics.⁸⁶ Another suggested purpose could be for shell S2184 (1758) (Fig. 29), representing a **pearl oyster** of the family Tridacnidae (*Tridacna maxima*). These shells are found throughout the Red Sea area and were often used in a cult as offering plates or as receptacles for cosmetics, especially for eye paints and other pigments.⁸⁷

2.4. Conclusions

The results of the excavations in the 2015 and 2016 seasons and their interpretation corroborate the continuity of the SIP settlement to the early 18th Dynasty. The continuity is supported by the stratigraphy of architectures as well as by the character of the material culture found in the occupation layers. Related architecture and assemblage were also found at Tell el-Maskhuta.⁸⁸

Although the Green House was quite modest, the finds from its interior testify to higher status activities situated inside its walls. There, finds have connections to the previous SIP/Asiatic MBA culture, probably due to trade and craft activities (scarabs, bone plaque, pigment raw materials, cosmetic equipment and sea shells). It seems likely

⁸² RUSMORE-VILLAUME 2008.

⁸³ PETRIE 1914, 27, pl. XIV–XV.

⁸⁴ WOODWARD in: ROTHENBERG and BACHMANN 1988, 208–209, fig. 82:87–88; 261–265, fig. 153:1–3.

⁸⁵ Similar in: JAMES and MCGOVERN 1993, fig. 145:4; WILSON 2011, 139–140, pl. 26:1–7.

⁸⁶ JAMES and MCGOVERN 1993, 200–201, fig. 146:1; JÁNOSI 2002, 208–210; For shells as a possible source of aragonite used for lead white pigment, cf. SCOTT 2016, 191.

⁸⁷ LUCAS and HARRIS 1962, 39, 80; WOODWARD in: ROTHENBERG and BACHMANN 1988, 263–265, pl. 153:15.

⁸⁸ REDMOUNT 1989, 228–243.

that the processing or handling of different raw materials (probably for cosmetic purposes) was at least a part of the preoccupation of the Green House's inhabitants. Such a preoccupation could also have continued in a later period, when the Green house was substituted by the more elaborate Black House 1.

3. 19th Dynasty

L.J, SRz

3.1. Fortress (phase E4, Area 9)

3.1.1. Building [1624]

Building [1624] and other structures in its proximity were first identified during two excavation seasons in 2014, clearing the upper parts of the walls for the most part⁸⁹ (Figs. 30, 31). The southern part of the building [1624] was thus discovered along with a section of the courtyard and a refuse dump outside it. The excavation trench was extended to the north in 2015, uncovering a room and more tops of walls in the northern part of the building [1624]. The layout of the building remains obscure, beyond the fact that walls [1624], [1625] and [1971] were outer walls and [1972] and [1973] were inner partition walls. The excavated part measured about 7.5 m by 7 m, but the building must have been larger. Walls [1975] and [1577] suggest that more rooms may be located to the east of the excavated part. Architectural remodelling and reconstruction over time are apparent, some walls ([1974] and [1975]) revealing a different construction technique and using different types of bricks. There seem to have been two doorways in wall [1973], one about 1.4 m wide, the other approximately 2.1 m (later blocked by wall [1974]).

A massive feature in the southern part of the building consisted of two long, roughly parallel walls with short interconnecting walls that created at least two small cells. The area where a third cell could be expected was covered by a mudbrick pavement. The structure resembles rectangular silos; its function, however, must remain obscure for now.

A floor (1970) was reached inside the building, between walls [1624], [1625] and [1973]. Found on the level of this floor was a fragment of a mudbrick bin [1976] and a diorite bowl on three stub

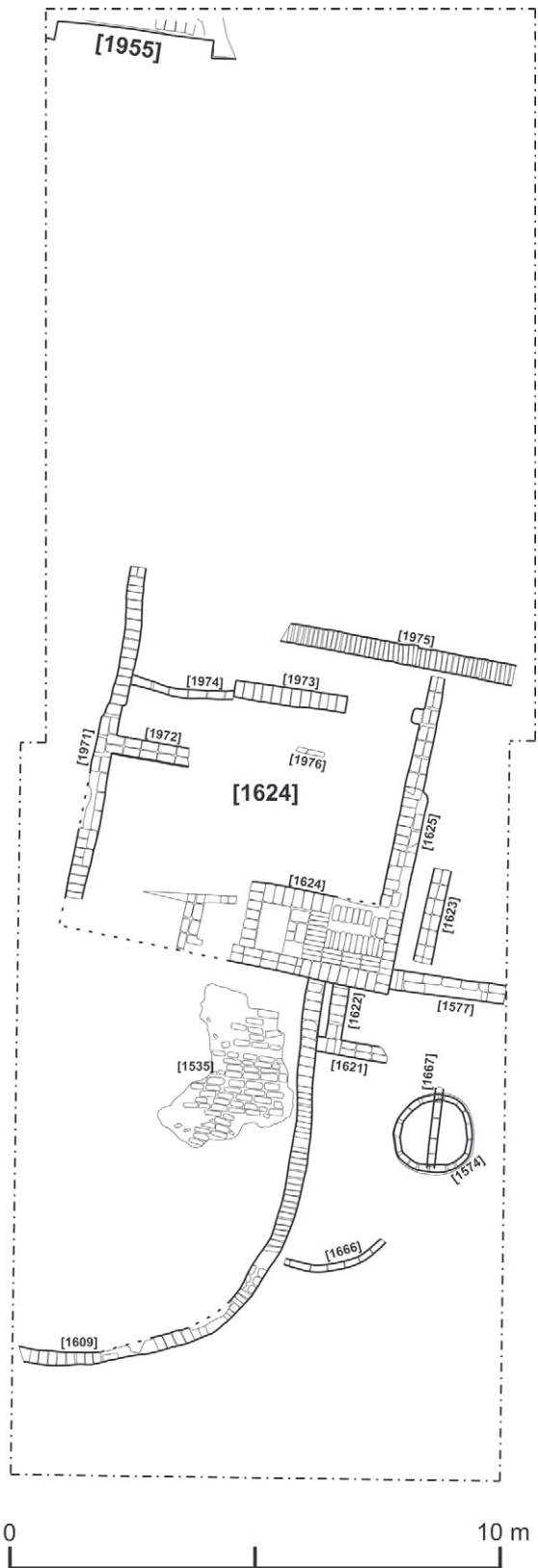

Fig. 30 Area 9, season 2015, plan of structures belonging to the 19th Dynasty fortress, phase E4 (drawing Ł. Jarmużek)

⁸⁹ RZEPKA *et al.* 2015, 108–112.

Fig. 31 Area 9, season 2015, building [1624] (phase E4) and silo [1256] (phase E3) (photo S. Rzepka)



legs S2683 (Fig. 32). The stone vessel was shallow (7.6 cm high) and had a diameter of 24.2 cm; the outer surface was rough, but the inside walls were well smoothed (from use?). A close parallel is known from Qantir,⁹⁰ but on the whole such ves-



Fig. 32. Diorite tripod bowl S2683 (photo P. Witkowski, drawing B. Adamski)

sels are fairly rare in Egypt,⁹¹ being much better known from Syria–Palestine. Both the Qantir and the Tell el-Retaba examples were probably produced locally, taking inspiration from vessels imported from the north-east, supposedly used as mortars in both everyday and cultic contexts.⁹² The smoothed inner surface of the Tell el-Retaba bowl suggests a use for grinding rather than crushing some sort of material.

3.1.2. Buttressed wall [1955]

Wall [1955] was found about 10 m to the north of building [1624], in the north-western corner of the excavation trench (Figs. 30, 33). The excavated part was 4 m long and at least 0.6 m thick. On the east it was cut by a very deep modern cut, on the west it runs beyond the trench with most of it being located outside the excavated area. Buttresses projecting about 0.2 m from the face of the wall reinforced it on the southern side. The two surviving buttresses were approximately 3.3 m apart.

The nature of the structure which this wall was part of could not be determined based on the excavated part, but it was surely of some importance: wall [1955], built during the 19th Dynasty, was still in use during the 20th Dynasty. All the other 19th Dynasty structures discovered so far, including the massive defence “Wall 1”, had been levelled at

⁹⁰ PRELL 2011, 89–90, fig. 34 [cat.-no. 435].

⁹¹ Those rare parallels are listed by PRELL, 90, n. 380–383.

⁹² BUCHHOLZ, 1963, 62 ff.

the beginning of the 20th Dynasty to clear the ground for a new, larger fortress that was built above their remains. Stratigraphical analyses indicate that wall [1955] was destroyed during the Third Intermediate Period (Fig. 34).

3.2. Fortress (phase E3, Area 9)

The extension of the excavation trench towards the north uncovered more structures added to those recorded in the southern part of the trench in



Fig. 33 Butressed wall [1955] (photo S. Rzepka)

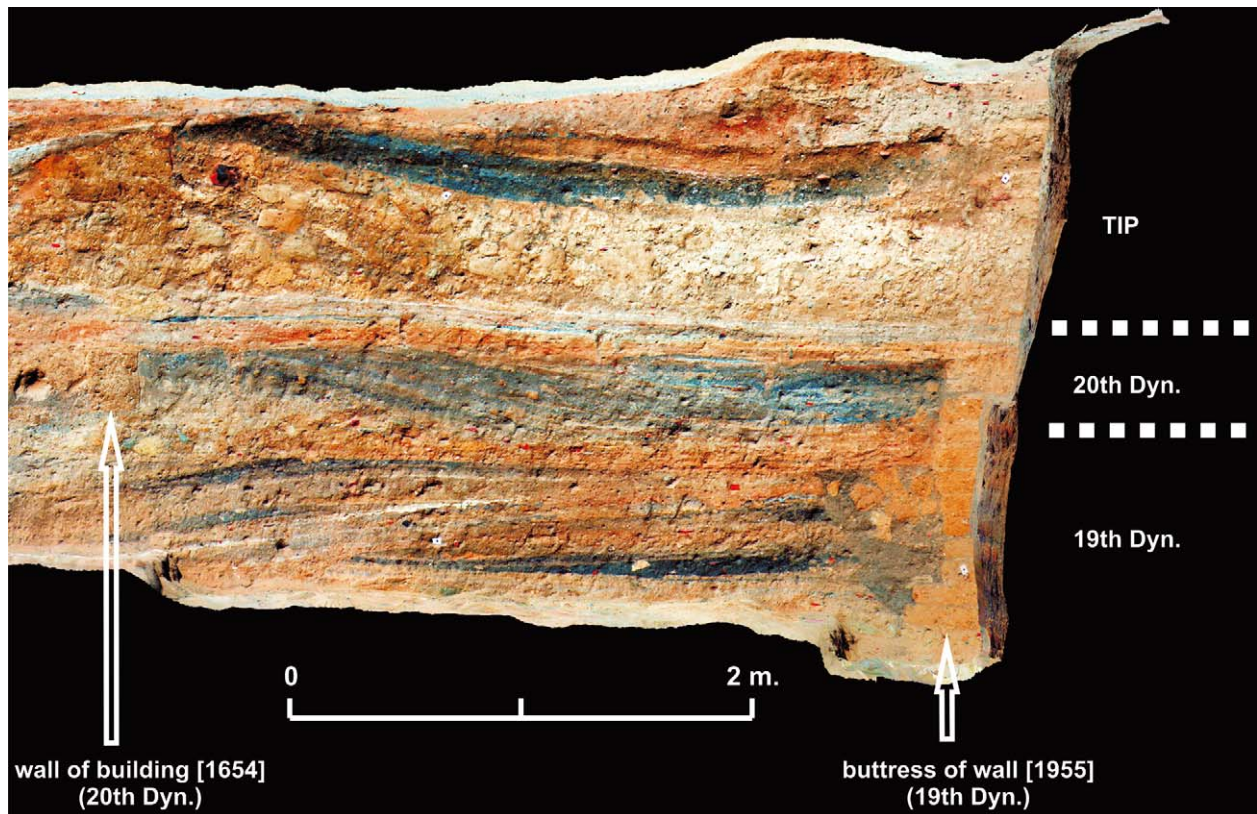

Fig. 34 Western profile of 2015 excavation trench in Area 9 (photo and processing P. Witkowski)

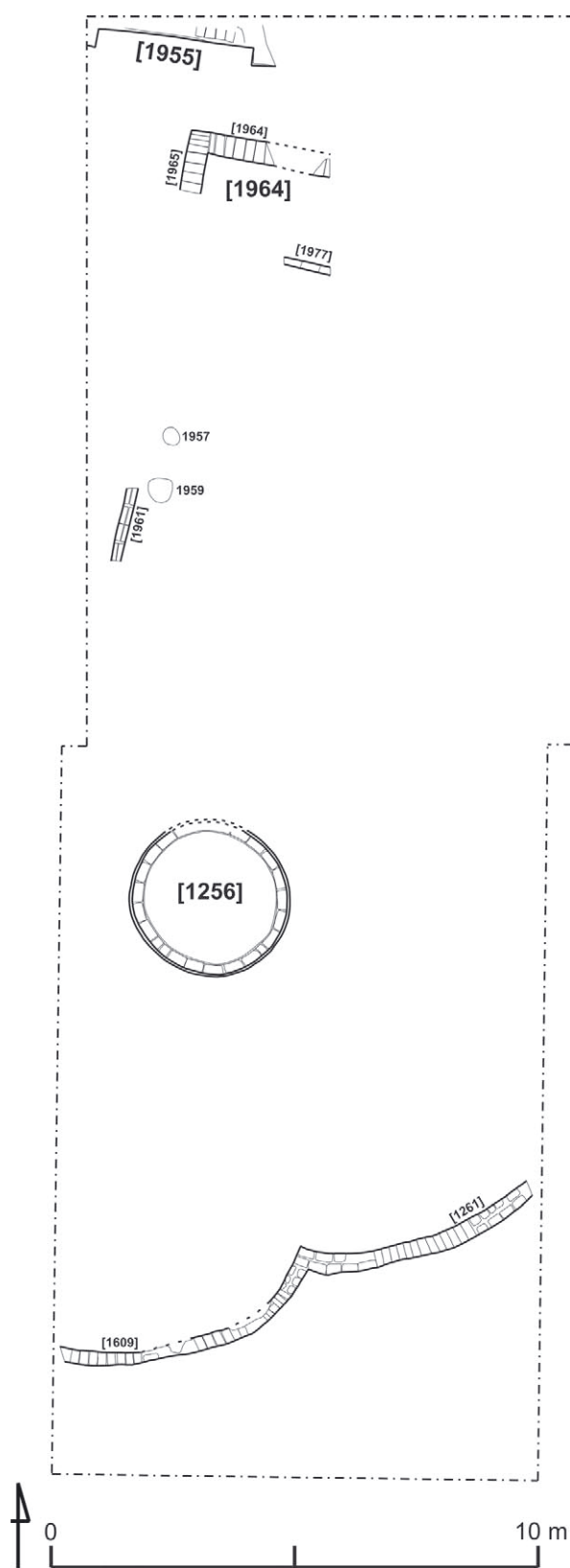

Fig. 35 Area 9, season 2015, plan of structures belonging to the 19th Dynasty fortress, phase E3 (drawing Ł. Jarmużek)

2014⁹³ (Fig. 35). Those in the southern part consisted of a large silo [1256], built on the ruins of building [1624] (cf. Fig. 31), and a courtyard wall from the earlier phase, now enlarged by a new wall. The newly-discovered structures were very poorly preserved. Wall [1961], surviving only as a single course of bricks, stood about 5.4 m to the north of silo [1256]. It was 0.2 m thick and was preserved for about 1.5 m. There were no traces of an associated floor. Instead, remains of two fireplaces (1957, 1959) were found beyond the north end of the wall. Both were represented by round, ashy deposits, 0.08–0.10 m thick, approximately 0.35–0.5 m in diameter. These deposits contained no finds.

About 13 m to the north of silo [1256], two walls, [1964] and [1965], formed the north-western corner of another structure. The surviving sections of these walls measured 1.2 m and 2.8 m respectively; both were 0.44 m thick. Only one layer of bricks was preserved. There were no traces of an associated floor. A fragment of wall [1977] was found about 1.8 m to the south of the building. It was 0.14 m thick and survived in a 1 m long section. The wall could have belonged to building [1964], but no direct connection between the structures was noted.

The remains of structures from phase E3 from both parts of the trench suggest that the area was probably a large open space with a silo and other relatively small structures, all enclosed by a wall. There was no evidence of any large buildings in the area.

3.3. Dump (phase E1, Area 9)

Finds from this phase, excavated in the southern part of the trench in season 2014, had indicated the presence of a refuse dump and a cemetery.⁹⁴ No further graves were found in the northern part of the trench in 2015, which was covered instead by a thick layer (1259) of ashes mixed with sand. Probably the entire area of this part of the trench (the eastern part has not been excavated at this level) was covered by this dumped deposit, reaching a total of about 300 m² surface area after two excavation seasons.

The dump layer contained numerous potsherds, animal bones and about one hundred small finds, such as beads, grinders, querns, whetstones,

⁹³ RZEPKA *et al.* 2015, 113–114.

⁹⁴ RZEPKA *et al.* 2015, 115–116.

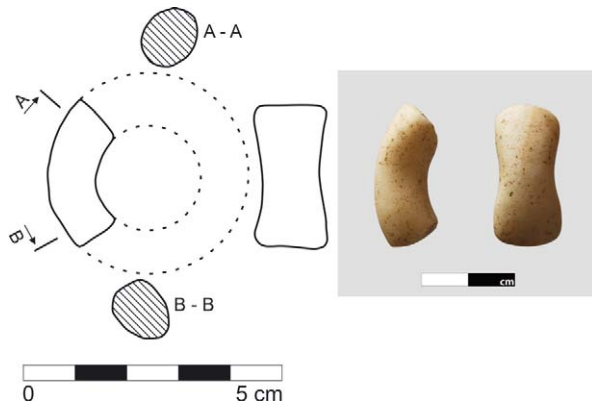

Fig. 36 Calcite penannular earring S2612 (photo P. Witkowski, drawing A. Ryś)

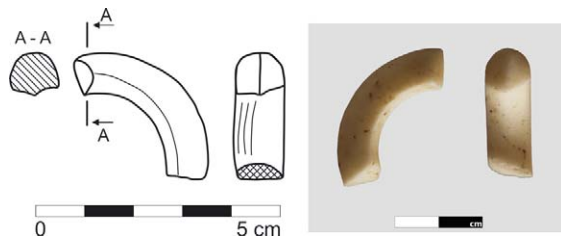

Fig. 37 Calcite penannular earring S2657 (photo P. Witkowski, drawing A. Ryś)



Fig. 38 Calcite bowl S2555 (photo P. Witkowski, drawing A. Poniewierska)

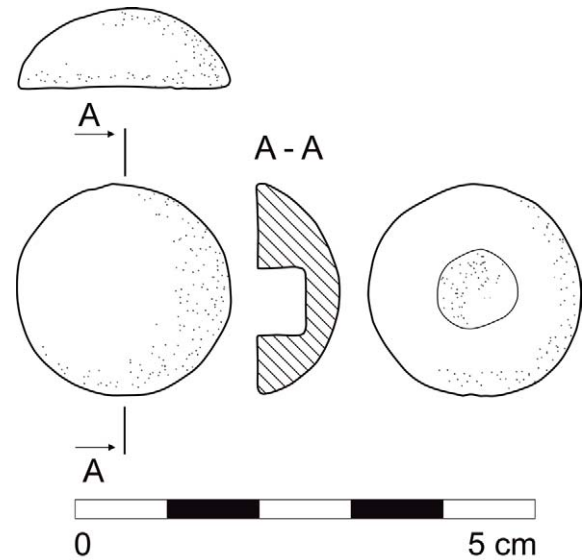

Fig. 39 Bone knob S2585 (photo P. Witkowski, drawing A. Ryś)



Fig. 40 Bead S2541, made of ostrich eggshell (photo P. Witkowski, drawing A. Ryś)

ceramic scrapers, needles, rings, faience and stone vessels. This assemblage gives an idea of the affluence of the community inhabiting Tell el-Retaba during the late 19th Dynasty. A number of items represents luxury goods: penannular earrings made of calcite (S2657, Fig. 36; S2612, Fig. 37),⁹⁵ a

fine thin-walled calcite bowl (S2555, Fig. 38) and a well worked piece of bone, probably a knob from a small box or other piece of furniture (S2585, Fig. 39). Valuable items included a bead (S2541, Fig. 40) and a disc made of ostrich eggshell⁹⁶ (S2639, Fig. 41). While not extravagant in number, these ‘luxury goods’ were clearly more common in the 19th Dynasty deposits compared to layers

⁹⁵ For parallels, cf. GIDDY 1999, pl. 21.

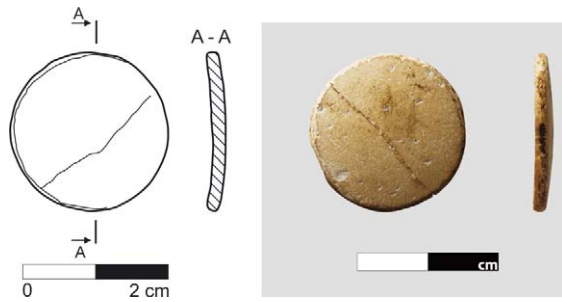

Fig. 41 Disk S2639, made of ostrich eggshell (photo P. Witkowski, drawing A. Rys)

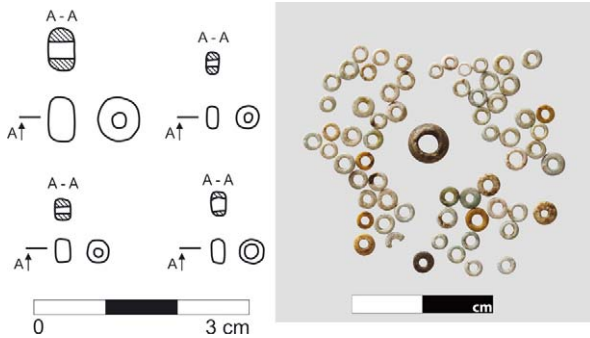

Fig. 42 Group of faience beads S2641 (photo P. Witkowski)

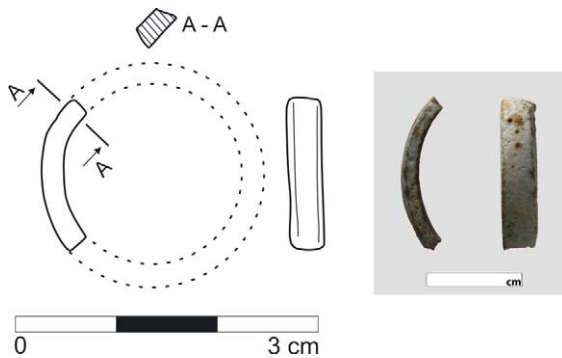

Fig. 43 Faience ring S2613 (photo P. Witkowski, drawing A. Rys)



Fig. 44 Mollusc shell S2589 with cutting marks (photo P. Witkowski)

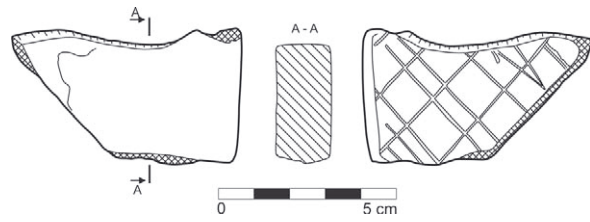

Fig. 45 Ramesside tool (S2647) made of Hyksos sherd (photo P. Witkowski, drawing A. Poniewierska)

from the 20th Dynasty and the Third Intermediate Period. However, the bulk of the small finds from the dump (1259) consisted of non-luxury items, among these numerous faience beads (S2641, Fig. 42) and rings (S2613, Fig. 43).

The said ostrich-eggshell disk (S2639) may be a half product; if so, it could suggest the presence of a workshop producing beads (as well as other items of personal adornment?) from this material. A mollusc shell with evident traces of intentional cutting makes this suggestion even more probable (S2589, Fig. 44).

A ceramic scraper (or whetstone) made from a potsherd is an interesting example of ancient ‘recycling’ (S2647, Fig. 45). It was found in a Ramesside context, but the vessel it was made from (a so-called ‘fish dish’) can be dated to the Hyksos period.⁹⁷

4. 20th Dynasty

ŁJ, SRz, AW

4.1. Beginnings of the fortress of Ramesses III (phase D4, Area 9)

Two significant layers (1248, 1250) found in the southern part of the trench in season 2014 continued in the northern part of the trench,⁹⁸ getting

⁹⁶ For the use of this material in ancient Egypt, cf. NICHOLSON and SHAW 2000, 332–333.

⁹⁷ Cf. ASTON and BADER 2009, 41–52, pls. 3–9.

⁹⁸ RZEPKA *et al.* 2015, 116–117.



Fig. 46 Bovine skull found in a deposit in phase D4
(photo S. Rzepka)

thinner towards the north and being reduced to just 2 m in width at the northernmost end. The relatively limited extent of both layers makes the earlier interpretation (as layers representing a phase of abandonment and levelling at the beginning of the 20th Dynasty, connected with the building of “Wall 2”) less feasible. A layer of debris (1920) covered this part of the trench instead. It had many fragmentary mudbricks and a relatively large number of small finds, 40 in all, including querns, grinders, pounders, ceramic scrapers, beads and pendants. There were also some bones, among them a relatively well preserved bovine skull (Fig. 46).

An infant burial (1954) was found in the southern part of the layer. The burial pit was disturbed, making it difficult to determine its extent. The rather poorly preserved bones of a small child were buried in a jar, of which a larger fragment of the base was preserved (Fig. 47). The jar was made of Nile B2 fabric and was covered with red slip. The vessel shape and surface treatment can be easily associated with the New Kingdom and even with the rim missing, it can be dated with considerable exactness to the late 19th or maybe even the early 20th Dynasty.⁹⁹

4.2. Fortress of Ramesses III (phase D3, Area 9)

The extension of the excavation trench allowed the investigation of the area to the north of building [834/838] (Fig. 48). This building, excavated since 2011, was a large structure extending along the southern defence wall of the fortress (Petrie’s

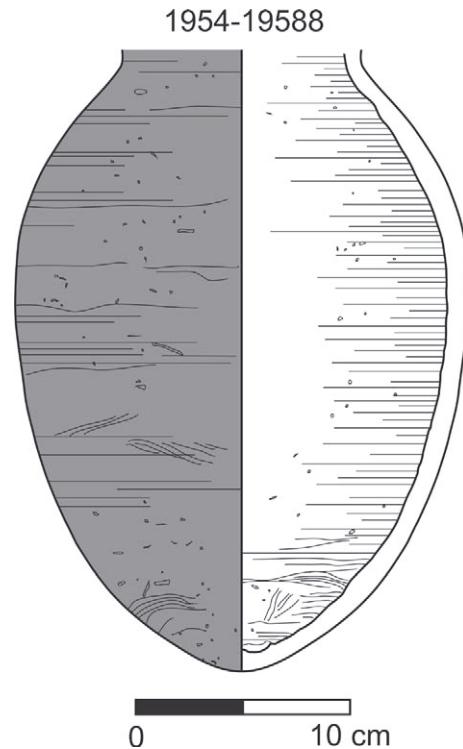

Fig. 47 Jar used as a child’s coffin in burial (1954)
Pottery drawings in the field were made by Barbara Jakubowska, Katarzyna Kasprzycka, Agnieszka Poniewierska, Katarzyna Szymańska, Katarzyna Trzcicka and Anna Wodzińska, later digitized by Katarzyna Szymańska and Anna Wodzińska.
All photos by Anna Wodzińska and Barbara Jakubowska.

⁹⁹ ASTON 1998, especially neckless jars, 198, nos. 586–592.

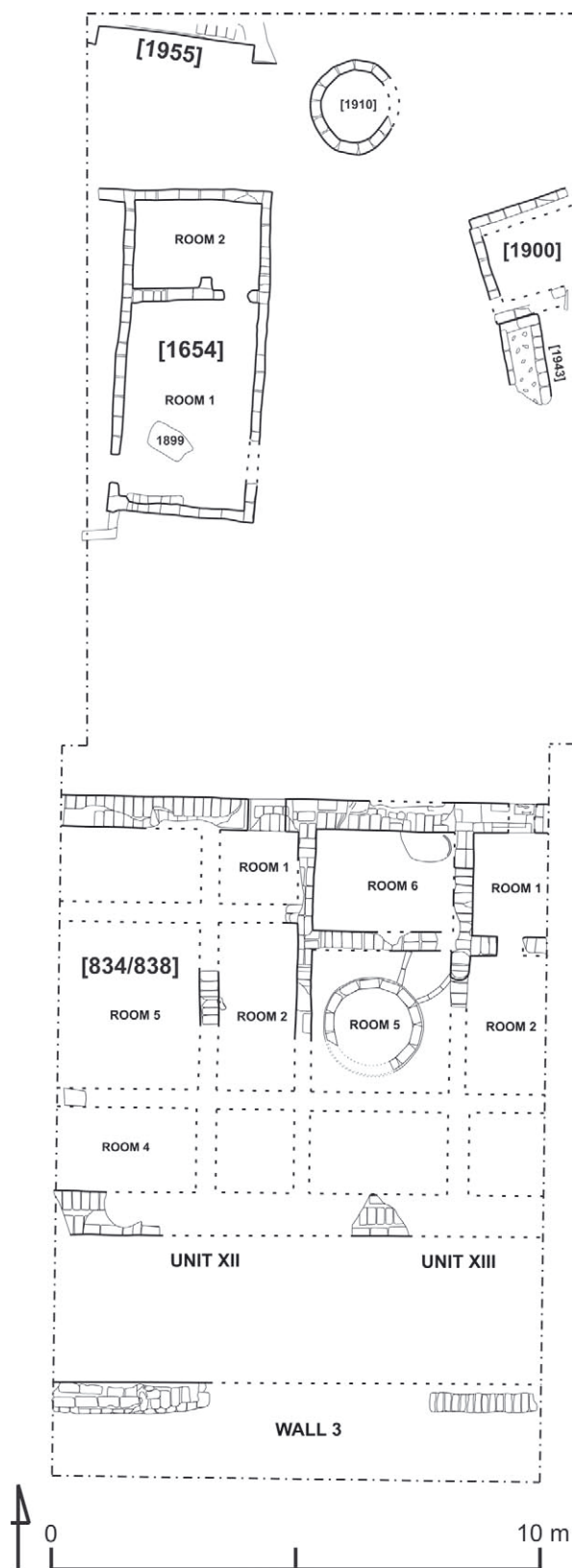

Fig. 48 Area 9, season 2015, plan of structures belonging to the 20th Dynasty fortress, phase D3 (drawing Ł. Jarmużek)

“Wall 3”).¹⁰⁰ Structures to the north of it were examined briefly in 2014,¹⁰¹ but a detailed analysis became possible with new data from the present seasons. In effect, two separate phases from the 20th Dynasty (D3 and D2) were discerned, modifying earlier assumptions in this regard.

4.2.1. Building [1654]

Building [1654] from phase D3 was contemporary with the first phase of the occupation of building [834/838]. The excavated part, 6.8 m by 3 m in size, was probably the eastern end of the original building. The walls were only 0.2 m thick and two of them continued to the west, beyond the excavated area. At least two rooms were traced, the entrance to them being in the south-western corner. Room 1 measured 4.2 m by 2.6 m. Floor (1891) inside the room contained a great deal of ashes and charcoal. Traces of a fireplace (1899) were found in the southern part of the room. The roughly rectangular shape of the fireplace may suggest that it had once been lined with mud-bricks. Several fragments of querns and grinders were found on this floor, as well as a spatula made of bone (S2618, Fig. 51), similar to other spatulae found earlier in Tell el-Retaba in previous seasons. They are usually interpreted as tools used in weaving or netting.¹⁰²

Large fragments of pottery vessels were scattered over the floor (Fig. 49), smashed probably after the room was deserted and the bricks from the disintegrating walls tumbled down on them. Altogether 30 bowls were recorded, these being used specifically for food preparation and consumption. There were also 25 storage jars and fragments of amphorae. The largest piece came from a storage jar with two handles, made of very fine marl D fabric. Its external surface was covered with creamy slip and well smoothed with some traces of burnishing. The best parallels are from Qantir.¹⁰³ Its surface (Fig. 50) bears traces of burning, probably secondary, but it is entirely possible that the jar was used at some point as a cooking pot or rather as a vessel for heating food. The assemblage from floor [1891] does not seem to be one set used in Room 1 of Building [1654]; the sherds were probably discarded there from other rooms. The vessels fit well in the early 20th Dynasty horizon.

¹⁰⁰ RZEPKA *et al.* 2014, 75–88, RZEPKA *et al.* 2015, 117–126.

¹⁰¹ RZEPKA *et al.* 2015, 125–126.

¹⁰² GIDDY 1999, 162–166, pl. 35.

¹⁰³ ASTON 1998, 468–469, especially nos. 1727–1729.



Fig. 49 Floor (1891) in room 1 of building [1654] (photo S. Rzepka)

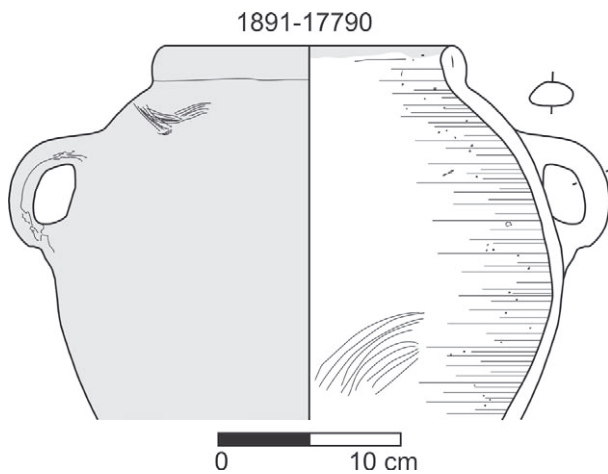

Fig. 50 Storage jar from floor (1891)

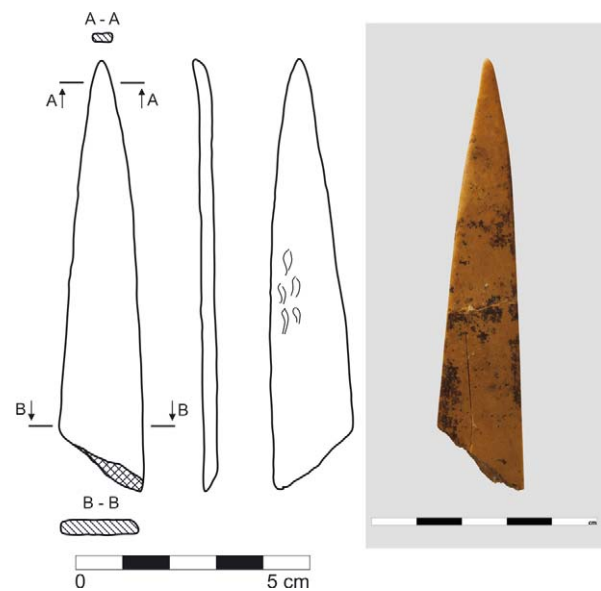

Fig. 51 Bone spatula S2618 (photo P. Witkowski, drawing A. Rys)

Room 2 was entered through a doorway in the northern wall of room 1. It measured 1.8 m by 2.6 m. About 20 stone tools were found on the floor (1892). They are made of various materials (quartzite, granite, limestone, basalt) and represent various types of tools: small querns¹⁰⁴ (S2449, Fig. 52), pounders (S2359, Fig. 53), grinders, polishers, and an implement interpreted as a cap stone

¹⁰⁴ For parallels, cf. e.g. GIDDY 1999, 201–205, pl. 43; PRELL 2011, 72–77.



Fig. 52 Small quern S2449 found in room 2 of building [1654] (photo P. Witkowski, drawing A. Poniewierska)

(“Druckstein”)¹⁰⁵ used for drilling (S2349, Fig. 54). Most of these artefacts were found in a pile next to the western wall of the room. Nine polishers made of quartz pebbles were clustered together in a spot to the west of room 2¹⁰⁶ (S2471, Fig. 55). This accumulation of various tools in room 2 and its neighbourhood points to the operation of a crafts workshop in this part of building [1654]. Identifying the craft is quite difficult, the tools being fairly multifunctional and suitable for various processes. As no production waste was observed anywhere in

¹⁰⁵ PRELL 2011, 81–83.

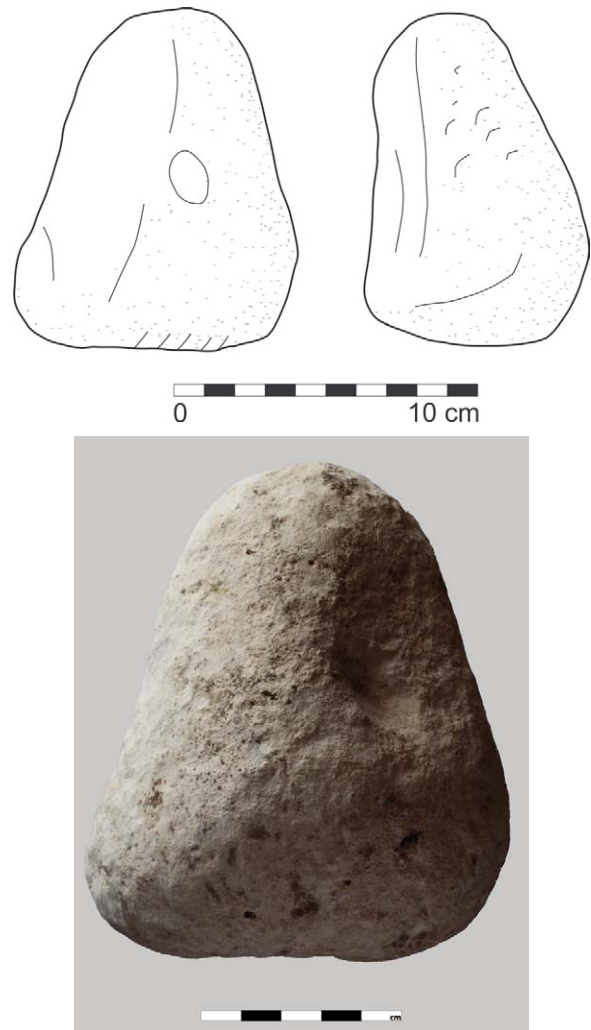

Fig. 53 Pounder S2359 found in room 2 of building [1654] (photo P. Witkowski, drawing A. Ryś)

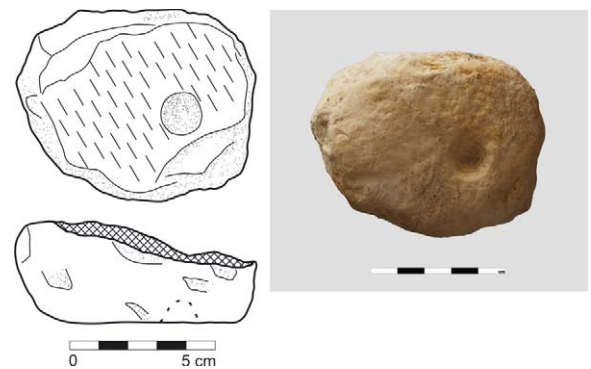

Fig. 54 Capstone S2349 found in room 2 of building [1654] (photo P. Witkowski, drawing A. Poniewierska)

the near vicinity, it seems plausible that organic materials (wood?, hide?), which have decayed completely, were processed there.

¹⁰⁶ Cf. PRELL 2011, 61, pl. 08.

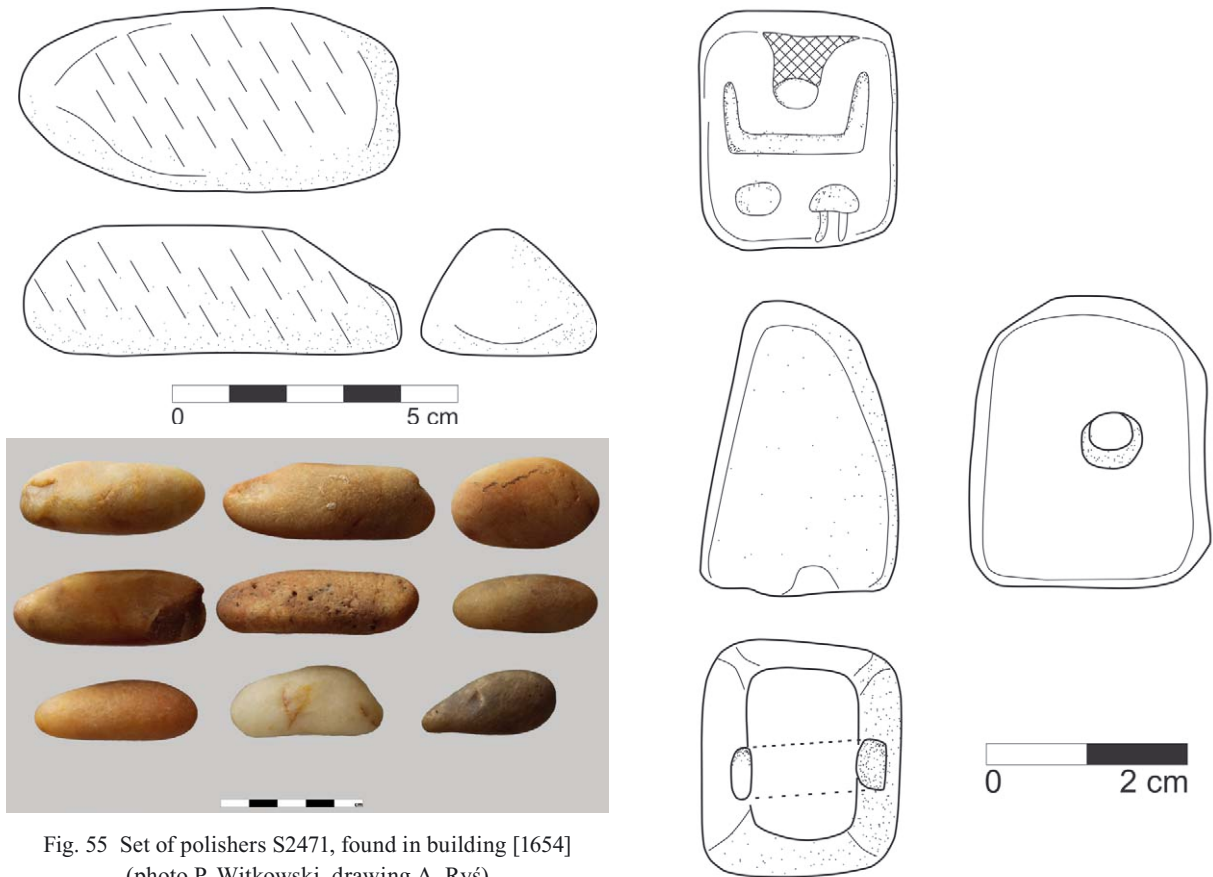

Fig. 55 Set of polishers S2471, found in building [1654]
(photo P. Witkowski, drawing A. Rys)

A small seal made of limestone (S2405, Fig. 56) with a short hieroglyphic inscription was discovered stuck to the eastern outer wall of the building [1654]. The inscription can be read as *R^c-nht(w)*,¹⁰⁷ most probably the name of its owner. Abutting the same wall from the east was a layer of black ashes mixed with sand, which probably came from a round fireplace (1917) found in the same area. The shallow pit of the fireplace was covered with a layer of clay.

A silo [1910] was situated next to the north-eastern corner of the building [1654]. A single course of bricks has survived, the walls having been destroyed by later structures. The external diameter of the silo was about 1.8 m, the wall thickness 0.2 m. The silo was filled with debris (1919), which contained a fragment of a quern.

4.2.2. Structure [1900]

Structure [1900] was found about 4.5 m to the east of building [1654] (Figs. 48, 57). Its original size and layout cannot be determined because of the destruction of the walls by later cuts. Moreover,



Fig. 56 Seal S2405 with the name *R^c-nht(w)*
(photo P. Witkowski, drawing B. Adamski)

the eastern part of the structure is beyond the excavated area. The unearthed part of the structure was rectangular in plan, measuring at least 2.2 x 2 m. It was a kind of platform, which could be accessed from the south via a ramp [1943]. The

¹⁰⁷ RANKE 1952, 302,18.

Fig. 57 Structure [1900]
(photo S. Rzepka)



ramp consisted of two parallel walls, with a space between them filled with brick debris. Two fragments of a jar stopper with seal impressions were found in this debris (the larger and better-preserved fragment S2521 is shown in Fig. 58). It was made of a grey mass, composed of mud mixed with gypsum (or lime). The tops of two cartouches, surmounted by feathers and solar discs with cobras, have been preserved, but the royal names are lost. On the bottom surface there is an impression of the material sealing the mouth of the jar before the stopper was inserted. The fairly regular pattern of this impression fits well with the fan-shaped leaves of the argun palm.¹⁰⁸

One should note the presence of a much older structure still standing further to the north. It was the buttressed wall [1955], built during the 19th Dynasty (see above).

4.3. Fortress of Ramesses III (phase D2, Area 9)

In the next phase during the 20th Dynasty, the space to the north of building [834/838] was rearranged. Building [1654] was probably still in use. At least some of its walls were still standing until phase D1, when they were used as the base of several silos (see below). With no preserved stratigraphic relations, it is difficult to say whether structure [1900] still existed.

A new building was raised next to the north wall of building [834/838] (Figs. 59, 60). Building [1648] blocked the entrance to unit XII in building [834/838], but this entrance was sealed anyway during this phase. The building was about 6.4 m long and 3.1 m wide. A parallel wall [1925] along its northern wall may have formed a kind of mastaba. The entrance, 0.7 m wide, was in the eastern wall. Inside the building, the eastern part was heavily damaged by modern cuts, but in the western part two levels of floors could be discerned. The level of the first floor (1934) yielded some pottery sherds, animal bones and small artefacts, that is, two fragments of querns and one grinder. A rectangular bin [1922] in the south-western corner of the room is associated with this phase. The second floor (1651), very similar to the first one, covered the walls of this bin. A round fireplace (1653) was recorded in the north-western corner of the room. A fragment of a quern was found on this floor, which was covered with layers of debris (1641, 1642). Remains of a silo [1927] stood by the west wall of the building.

4.4. Fortress of Ramesses III (phase D1, Area 9)

The space to the north of building [834/838] was further rearranged in phase D1 (Fig. 61). Stratigraphic relations observed in the case of the ashy layer (1893), which abutted the southern wall of

¹⁰⁸ For the argun palm in the Dynastic period, cf. GERMER 1985, 235.

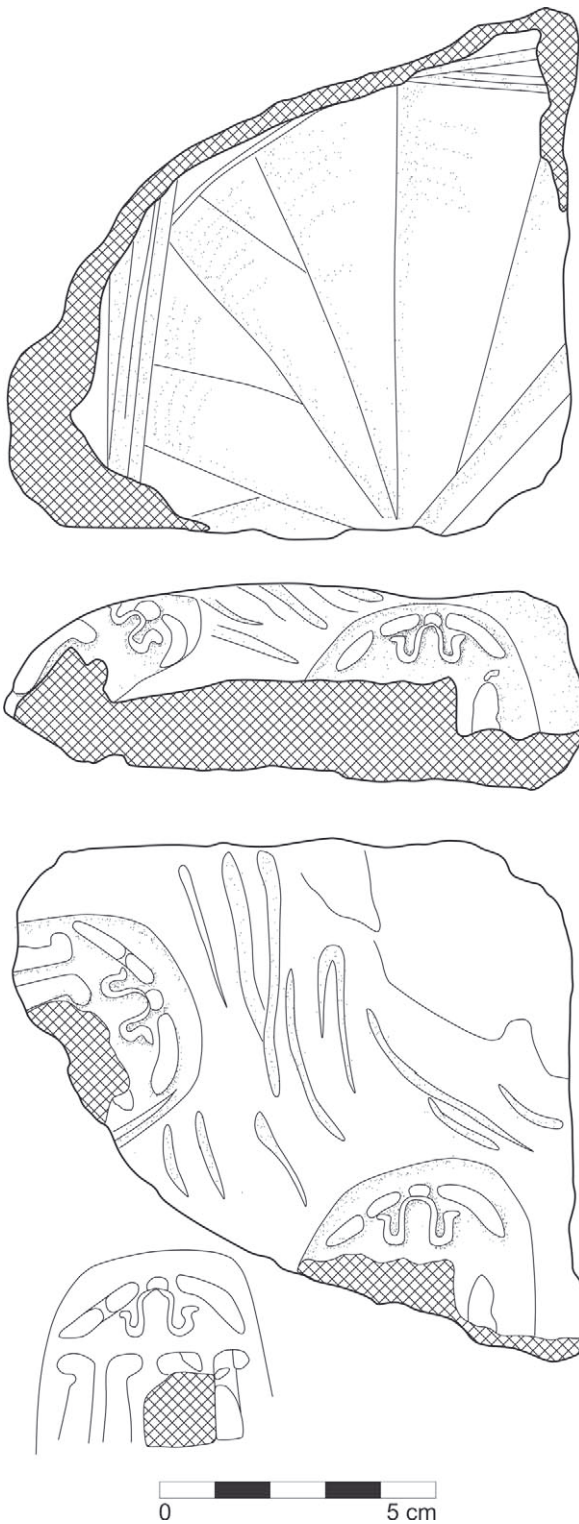

building [1654] and which covered the walls of building [1648], prove that the walls of building [1654] must have still been standing in phase D1 (see above) and that building [1648] had disappeared. The layer yielded a set of five cowry shells (S2382–2386, Fig. 62) with the dorsal parts cut off and polished to make the shells flatter, probably to be strung into a necklace.



Fig. 58 Jar stopper with seal impressions S2521 (photo P. Witkowski, drawing B. Adamski)

Several silos were constructed on top of layer (1893) (Figs. 61, 63).¹⁰⁹ They were preserved to a height of one or two bricks. Their internal diameters ranged from 1.0 to 1.44 m. East of silo [1657] there was a wall [1887] preserved for a stretch of 2.7 m. A walking level (1888) was associated with it on the southern side. It was a grey, ashy layer with a small number of potsherds and no small artefacts.

Summing up, excavations carried out during the 2015 season in the 20th Dynasty fortress (phases D3–D1) have confirmed observations from earlier seasons of excavations in the western part of area 9. The large, well planned and soundly constructed building [834/838] was raised in phase D3 as part of a state-controlled project designed to build a new fortress to watch over the route linking Egypt with Sinai and Syria–Palestine. It was ‘privatised’ later, during phases D2–D1. Significant changes took place inside the building. The uniform system of ‘units’ (flats) composed of six rooms was abandoned: some walls were removed, some old doorways were blocked and new doorways cut in other places, some rooms obviously changed their function. These changes are observable also outside the building [834/838], on its northern side. In phase D3, the space along the northern façade was free of any structures, serving as a passage from which entrances led to each unit (flat). During phase D2 this space was blocked with new, rather clumsily constructed structures

¹⁰⁹ RZEPKA *et al.* 2015, 125–126. The previous dating of the silos to phase D2 has been changed to phase D1 based on data collected in 2015.

([1648], [1927]). Consequently, building [1648] was already in a ruined state in phase D1.

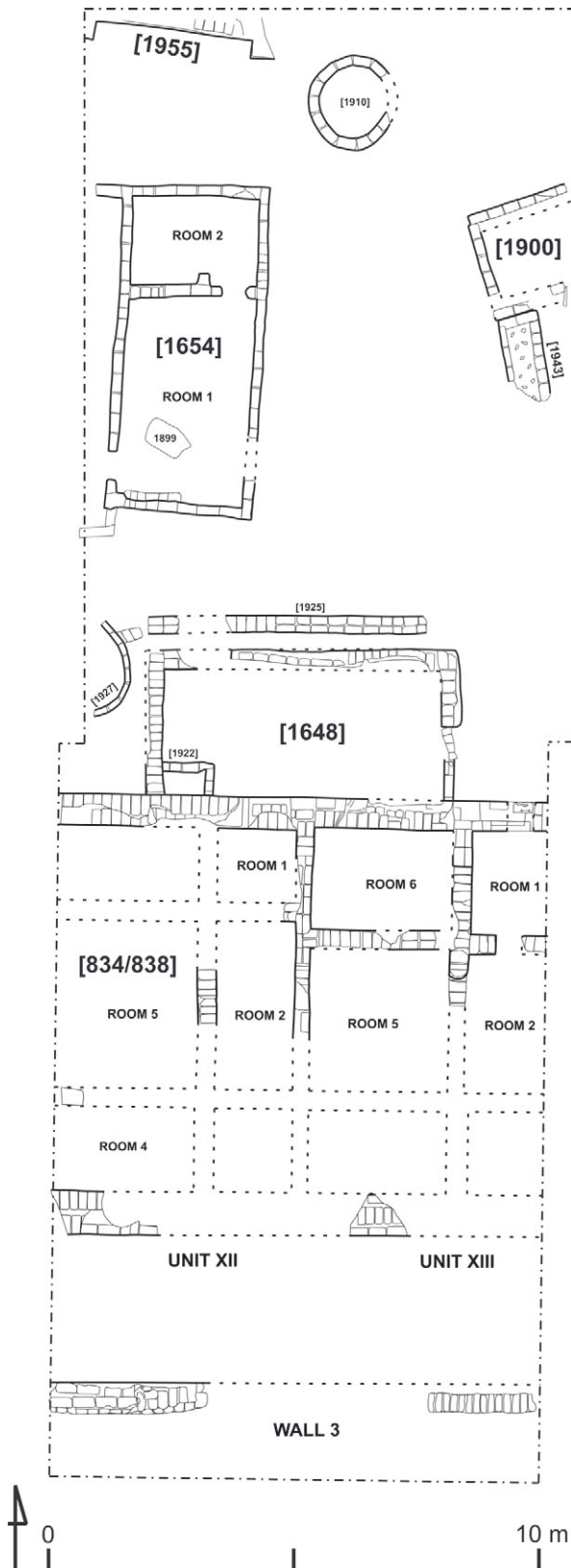

Fig. 59 Area 9, season 2015, plan of structures belonging to the 20th Dynasty fortress, phase D2 (drawing Ł. Jarmużek)

A second conclusion following the 2015 season is that some 19th Dynasty structures were still in use during the 20th Dynasty. Earlier seasons had shown already that the 19th Dynasty defence walls (Petrie's "Wall 1"), barracks and silos were levelled at the beginning of the 20th Dynasty to prepare ground for a new fortress. The buttressed wall [1955] excavated recently was erected during the 19th Dynasty and was still standing at the end of the 20th Dynasty. While it is not yet possible to determine the nature of the structure that wall [1955] belonged to (a temple perhaps), it is clear that architects planning the 20th Dynasty fortress evidently had to take into consideration the presence of older, still standing structures.

5. Third Intermediate Period

LJ, AW, SRz

Excavation work in 2015 and 2016 contributed new data on Third Intermediate Period remains, adding to the information available from earlier seasons. The results of seasons 2011 and 2012 were published¹¹⁰ before the introduction of the new phasing system,¹¹¹ hence the necessity to rename phases used in the previous report as follows: phase 6 = phase C4, phase 5 = phase C3, phase 4 = phase C2, phase 3 = phase C1, phase 2 = phase C1–C4.

5.1. Settlement (phase C4, Area 9)

Several structures were found in 2015, completing the picture of the space arrangement in phase C4 that was based on the results of the 2014 season.¹¹² The area in phase C4 was occupied by building [1607] and a large open court to the east of the building (Fig. 64). Two ovens, [1600] and [1601], were found in the courtyard. They were surrounded by thick layers of ashes. All the finds suggested that the area was used for bread-baking. More structures of the kind were discovered 2 m to the north of the ovens. Oven [1935] and its fill were partly destroyed by a later cut, leaving only the eastern part intact. The regular construction consisted of a ceramic ring wall that was 3 cm thick, covered with a layer of mud, measured to be about 6 cm thick. Wall [1939] was found to the north of the oven. It was 0.40 m thick; an about 1.6 m long

¹¹⁰ RZEPKA *et al.* 2014, 86–93.

¹¹¹ RZEPKA *et al.* 2015, 97–98.

¹¹² RZEPKA *et al.* 2015, 127–130.



Fig. 60 Buildings [1648] (left) and 1654 (top right) (photo S. Rzepka)

section was excavated. The wall continued to the east, running beyond the trench. A circular bin [1942], about 1.74 m in diameter, was found directly to the west of the oven. The wall thickness was 7 cm. The walls and the bottom of the bin were of unfired clay (Figs. 64, 65) The bin may have been linked functionally with the oven; the dough may have been prepared there. Some large and relatively well-preserved animal bones were found in the sandy fill (1941). The space between wall [1939], oven [1935] and bin [1924] was filled with a thick layer of ashes (1938). It did not contain any artefacts.

5.2. Settlement (phase C3, Area 9)

Two relatively large buildings from phase C3 were partly excavated in 2016 (Fig. 66). They were situated 2 m to the north of building [991] and were discovered during the previous seasons.¹¹³ The space between these buildings was destroyed completely by a modern cut. Thus, there is no direct stratigraphic relation between these structures. However, the similar orientation and level of the foundation of the buildings allow them to be placed in the same occupation phase of the site.

5.2.1. Building [2227]

Building [2227] was excavated only as far as the clearing of the tops of two walls in the eastern part of the structure in preparation for future research

(Figs. 66, 67). The western part of the building was probably destroyed by modern cuts, which abound in this area. The building was about 8.5 m long and at least 2 m wide, the thickness of walls being 0.6 m.

5.2.2. Building [2147]

Building [2147] abutted the eastern wall of building [2227] (cf. Figs. 66, 67). It was roughly trapezoidal in plan, 8.5 m long and 4.8–5.5 m wide. Most of the building is relatively well preserved, some walls in the northern part of the building stand 1.3 m high. The condition of the southern part was much worse, the southern wall being almost completely destroyed by a large modern cut. The building consisted of two rooms. Room 1, in the northern part of the building, measured 3.7 x 2.3 m. The northern part has been excavated, revealing the oldest recorded feature inside the room which was a bin of some kind or a low wall [2225]. It was built about 0.4 m to the west of the eastern wall. In its north-eastern corner there was the bottom part of large pottery vessel (2240), which must have served as a storage vessel. Floor (2220) accumulated over time to the west of the bin. The floor contained a small amount of pottery and ashes as well as an interesting set of small finds, which included nine weights (probably loom weights)¹¹⁴ made of unbaked mud. They were found in one spot next to the northern wall of the room, suggesting that a loom had once stood there.

¹¹³ RZEPKA *et al.* 2014, 86–88.

¹¹⁴ For parallels, cf. JARMUZEK 2010.

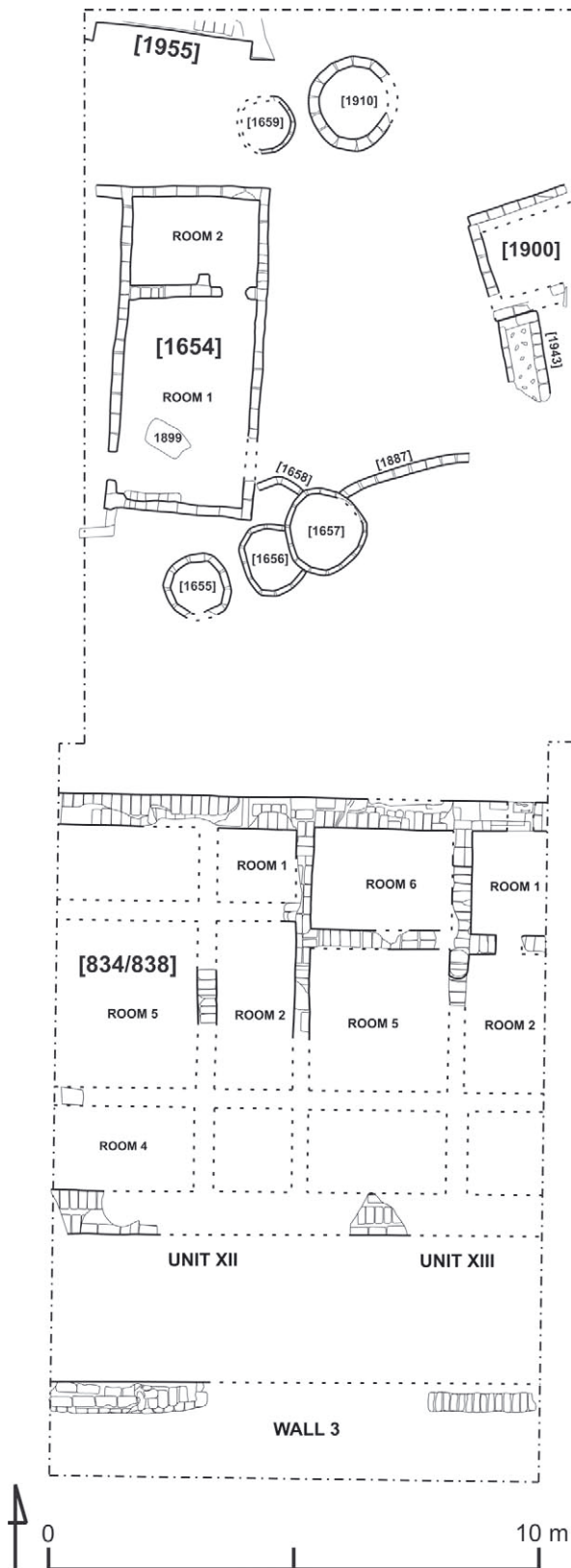

Fig. 61 Area 9, season 2015, plan of structures belonging to the 20th Dynasty fortress, phase D1 (drawing Ł. Jarmużek)



Fig. 62. Group of worked cowry shells S2382–2386 (photo P. Witkowski)

Three of the weights from this set (S3109, S3110, S3112) are shown in Fig. 68. Not only weaving, but also spinning took place in this room, as confirmed by a limestone spindle whorl found in the same floor layer (S3132, Fig. 69).

There were also other tools in the same context (three grinders, three fragments of querns, a slate palette), a fragment of a stone vessel and a faience scarab (S3126, Fig. 70). Incised figural decoration on the scarab base depicts a king seated on a throne with a smaller human figure standing in front of him.¹¹⁵

After some time, a new large storage vessel (2213) replaced the older one (Figs. 71, 72). It was made of Nile B2 sandy fabric. The external surface was only smoothed; patterns of impressed string used to secure the walls of the pot during the drying process are well visible on the surface. The internal surface was much rubbed off, to the point that the upper layer is gone. This damage occurred while the pot was used for a long time to store water. Vessels of this type are well known from Third Intermediate Period contexts, e.g. from Qantir.¹¹⁶ Its shape is probably a late Nile alluvium version of the New Kingdom ‘meat jars’.

The area to the south of the vessel was enclosed by a rounded wall [2221], which probably created a kind of bin. The wall abutted the vessel, showing no evidence of a cut that would suggest the installation of the vessel after the construction of the bin (cf. Fig. 71). An ash layer (2223) filled the bin. It is clear from the presented evidence that the eastern part of the room served the same purpose over a length of time. The old storage jar and the bin were replaced by similar installations. All the features inside the room were covered with a relatively

¹¹⁵ For a close parallel to this type of decoration, cf., for example, the scarab in the Egyptian Museum in Cairo CG 37104, 19th Dynasty (NEWBERRY 1907, 277, pl. IX). Cf. also PETRIE and DUNCAN 1906, pl. XXXIII (68); PETRIE 1925, 26, pl. XV (987).

¹¹⁶ ASTON 1998, 562, fig. 6.04. and nos. 2293–2305.



Fig. 63. Building [1654] (right) and group of silos [1655], [1656], [1657], [1658] (top) (photo S. Rzepka)

thick layer of debris (2216). It consisted mainly of sand and fragments of bricks. The layer was significantly thicker in the eastern part of the room, suggesting that the eastern wall was more destroyed

than the others. This assumption is strengthened by the presence of later structures (see below) using the southern, northern and western walls of room 1. The entrance to the room was definitely not in the northern or western walls, but at the present stage of research it is impossible to suggest its tentative location. It may be identified once the other half of the deposits inside the room is explored and the faces of the eastern and southern walls are cleaned. Room 2 measured 4.35 x 4.15 m. The excavation reached the level of debris covering this area, hence other walls may yet be found, bringing up the total number of explored rooms.

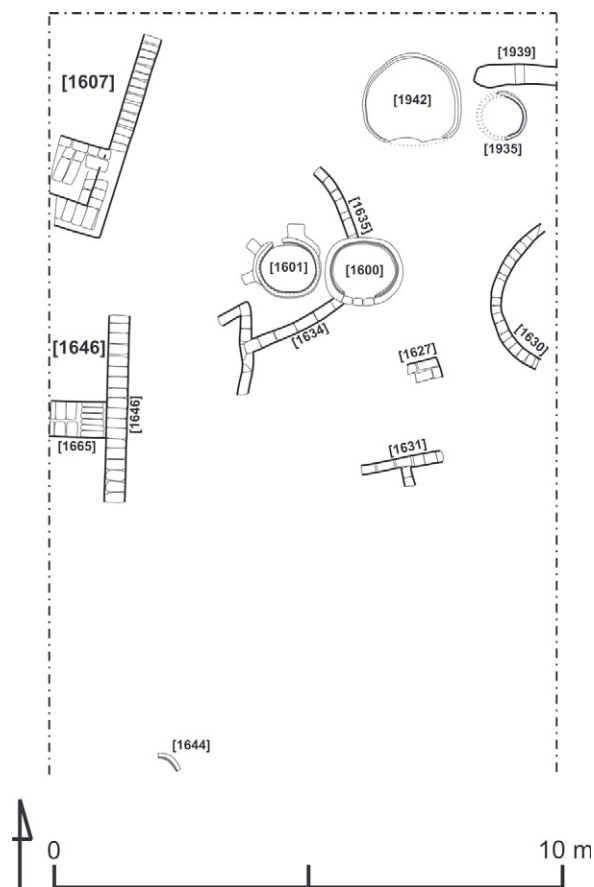

Fig. 64 Area 9, season 2015, plan of structures belonging to the Third Intermediate Period settlement, phase C4 (drawing Ł. Jarmużek)

5.2.3 Building [2199]

Building [2199] was situated about 3 m to the north of building [2147] (cf. Fig. 66). Only the tops of some of its walls have been cleared so far. The building measured at least 5.3 m by 5 m, the thickness of the walls being about 0.6 m. The walls matched in alignment the walls of building [2147], but the level of the foundation was lower. Thus, building [2199] appears to be slightly older (built in phase C4), but both structures functioned concurrently in phase C3.

5.3. Settlement (phase C2, Area 9)

Two structures dated to phase C2 in Area 9 were discovered in the seasons 2011–2012.¹¹⁷ The first one was building [991] modified by the addition of

¹¹⁷ RZEPKA *et al.* 2014, 89–90.

Fig. 65 Oven [1935] (left), bin [1942] (middle, both phase C4) and oven [1910] (right, phase D1) (photo S. Rzepka)



a new room. The second one, a single-room building [765], was found about 2 m to the south-east. Between the two buildings there was thick, ashy layer (993). In 2016, the area to the east and north of these buildings was excavated (Fig. 73). New data changed the picture of the settlement layout in phase C2 significantly. Two new buildings were discovered: [1095] to the north-east and [2196] to the north. A space free of any structures opened between buildings [991], [765] and [1095].

5.3.1. Open space between buildings [991], [1095] and [765]

The excavated part of the open space measured roughly 9 m by 10 m. Thick layers accumulated over this area in two sub-phases. In the first one, layer (2145) spread not only between buildings [991], [765] and [1095], but also in the narrow passage between the northern wall of building [991] and building [1095]. More excavation is needed, but the layer was observed in the section of a large, modern cut. It was 30 cm thick and consisted of a series of sand and ash laminas. It yielded a large number of potsherds, animal bones and several artefacts. In the second sub-phase, the narrow passage between buildings [991] and [1095] was blocked by wall [2155]. Thus, the passage from the open space to building [2196] was cut off. The space was covered with a sequence of sand and ash laminas forming layer (993). It also contained a great deal of potsherds and animal bones, but few artefacts.

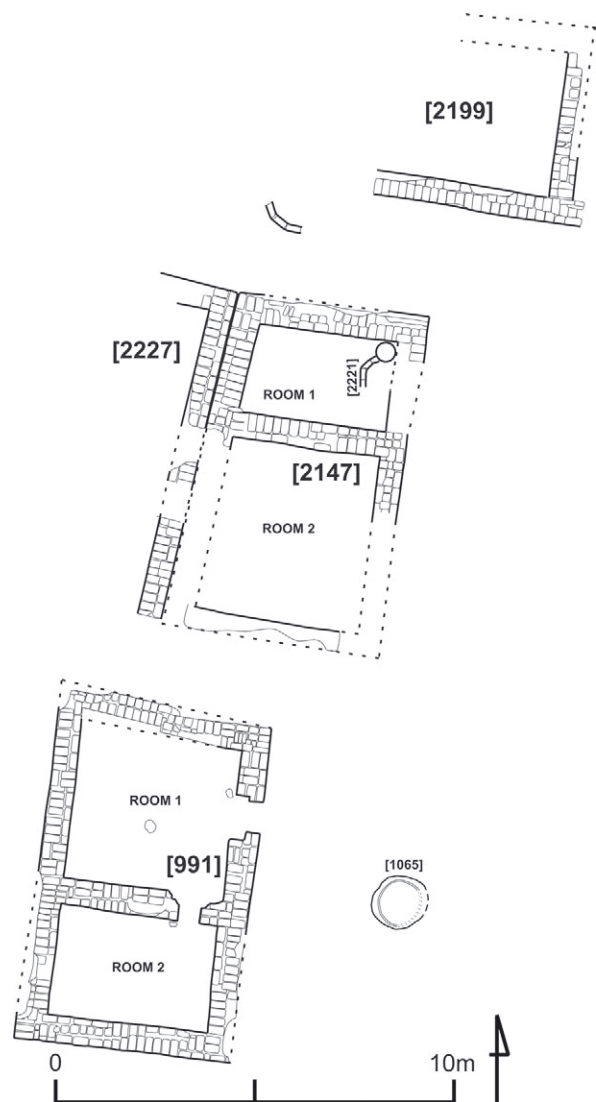

Fig. 66 Area 9, season 2016, plan of structures belonging to the Third Intermediate Period settlement, phase C3 (drawing Ł. Jarmużek)



Fig. 67 Building [2147], room 1 (phase C3); building [2196], room 2 (phase C2); building [2227] (phase C3-C2); building [2143] (phase B) (photo S. Rzepka)

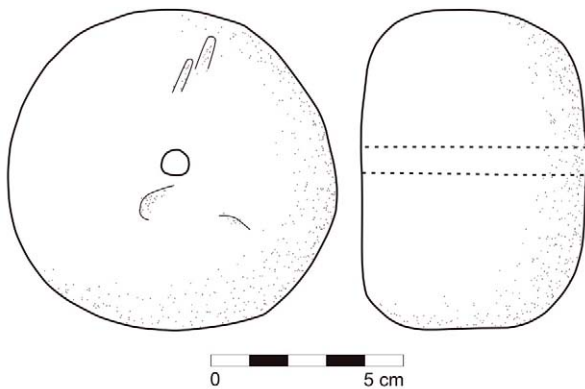

Fig. 68 Loom weights S3109, S3110, S3112, found in building [2147], room 1 (photo S. Rzepka, drawing A. Rys)

5.3.2. Building [1095] (Figs. 73, 74)

Building [1095] was built slightly later than room 3 of building [991]. This can be inferred from the fact that a layer in the open space, which goes under the walls of building [1095], abuts the eastern wall [1083] of building [991]. Except for the northern end (which is covered by building [2074] from phase B, see below), building [1095] has been excavated, revealing a trapezoidal ground plan roughly 9 m by 7.7 m that remained unchanged over time. A relatively thinner wall [2163] abutting the building from the east suggested a courtyard of some kind, which was entered via a door in the eastern wall [2079]. The four rooms of this building underwent significant alterations in terms of how they were interconnected. Three sub-phases were discerned on these grounds. First, there were two entrances to the building in the southern wall. The western entrance was 0.55 m wide and led to room 1. The jambs of the doorway were on the inside, but no door-socket was found.

Room 1 measured 3.9 x 5.2 m. A floor (2183) of whitish-grey colour filled the room. There were no remains of any installations. The floor layer con-

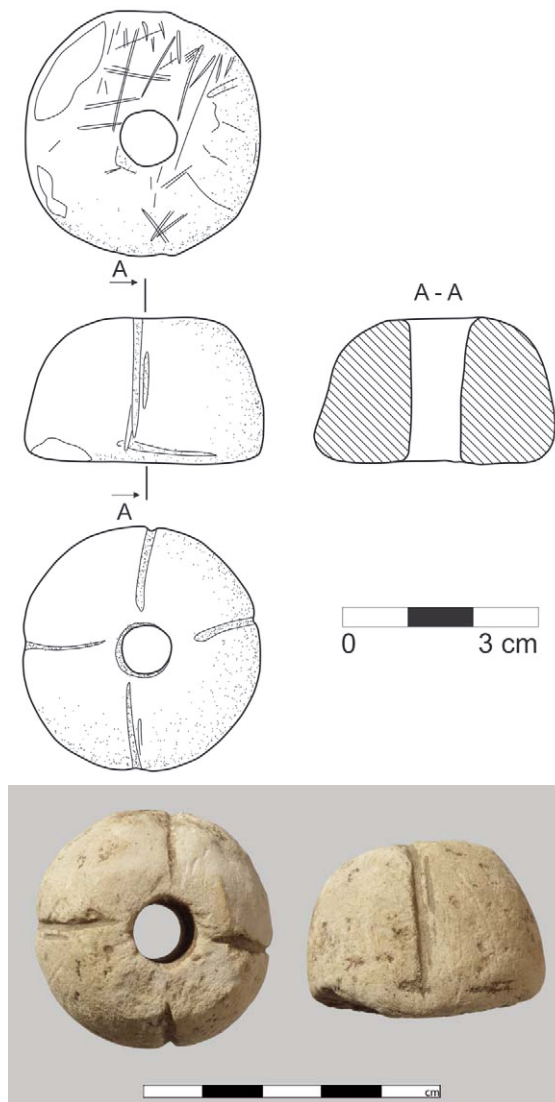

Fig. 69 Spindle whorl S3132, found in building [2147], room 1 (photo S. Rzepka, drawing L. Hulková)

tained a small amount of pottery, animal bones, ashes, and several small finds, mostly tools: two fragments of whetstones, two grinders, a pottery disc, a bronze needle and a loom weight (S3107, Fig. 75). Such loom weights (made of limestone, of ovoid shape, with a vertical groove along the longer axis) are quite common in Tell el-Retaba in Third Intermediate Period contexts; a number of them were found in earlier seasons.¹¹⁸ One should note two faience amulets from this context. The first one (S3054, Fig. 76) is a pendant in the form of an aegis, that is, the head of the goddess with a broad-collar necklace. It is in this case a lion- or cat-headed goddess, with an ureaus and a sun disc – either Bastet or Sakhmet.¹¹⁹ The other amulet (S3108, Fig. 77) is also a pendant, but this time in the form of a full, standing figure of Bastet or Sakhmet.



Fig. 70 Scarab S3126, found in building [2147], room 1 (photo S. Rzepka, drawing L. Hulková)

Room 2 was entered from room 1 via a doorway that measured 0.6 m in width, situated at the western end of the northern wall of room 1. The jambs were on the side of room 2. This second room was not excavated; it probably measured 3.2 m by 5.3 m.

The eastern entrance to the building was relatively wide at about 1 m; it led to room 4, which measured 2.6 m by 3 m. The floor of this room was a cemented, grey layer (2117), which covered the entire area of the room. It contained some ashes, a small number of potsherds, animal bones, a grinder and a quern. Structure [2157] was built after some time in the north-western corner of the room (Fig. 78). The narrow space between the structure and the wall of the room suggests that it was a kind of mastaba rather than a bin. A doorway in the southern part of the eastern wall of the room led to the courtyard. A limestone door-socket was embedded into the northern jamb. Another doorway was situated in the northern wall of the room.

¹¹⁸ Cf. JARMUŹEK 2010.

¹¹⁹ Aegis amulets are quite common in the Third Intermediate Period and later. An aegis (made of silver) with the head of Bastet was found by W.M.F. Petrie in tomb 20 in Tell el-Retaba (PETRIE and DUNCAN 1906, 32, pl. XXXIVA).



Fig. 71 Large storage jar (2213) found in situ in building [2147], room 1 (photo S. Rzepka)

This doorway led to room 3, which measured about 2.5 m by 3 m. Only the southern part of this room was excavated. Floor (2241) was present throughout the room and there were no traces of installations. The door jambs were placed on the side of room 3, but there was no door-socket (in

the case of the floor from the next sub-phase, a door-socket was placed next to the eastern jamb, see below). It is not clear at present whether there was a doorway between rooms 2 and 3. If not, then the building would have consisted of two separated units.

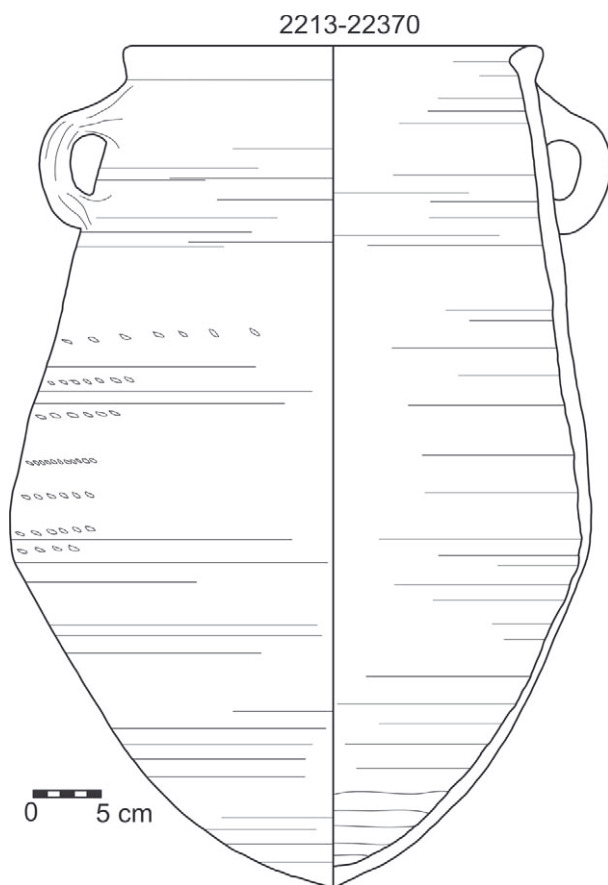

Fig. 72 Large storage jar (2213)

In the second sub-phase of building [1095], the eastern entrance was blocked with mudbricks [2206] laid directly on the floor surface (2117) (Fig. 79). It follows from this alteration that rooms 2 and 3 were somehow interconnected to allow communication between all the rooms. The floor level was raised uniformly about 10–20 cm. In room 1, floor (2176) was a whitish-grey layer, filling the room and yielding a relatively small number of potsherds and animal bones. Only four small artefacts were found: a stone vessel fragment, a pounder, a ceramic scraper and a fragment of a bronze needle. A bin [2218] was found next to the western wall of the room, its walls a mere brick high. It measured 0.5 m by 1.7 m and was filled with an ashy layer (2217) without any finds. In room 4, a new floor (2116) covered structure [2157]. The floor contained much more ashes than the previous one.

Traces of fire use were noted in several places inside room 4. A semi-circular layer of ashes (2153) was found next to the western wall of the room (cf. Fig. 78). Some bricks in the wall above the layer were burned and bore traces of soot. This proves that unit (2153) was not just an ash dump, but a fireplace in its own right. A second similar unit (2154) of ashes along the southern wall of the room did not coincide with traces of fire on the

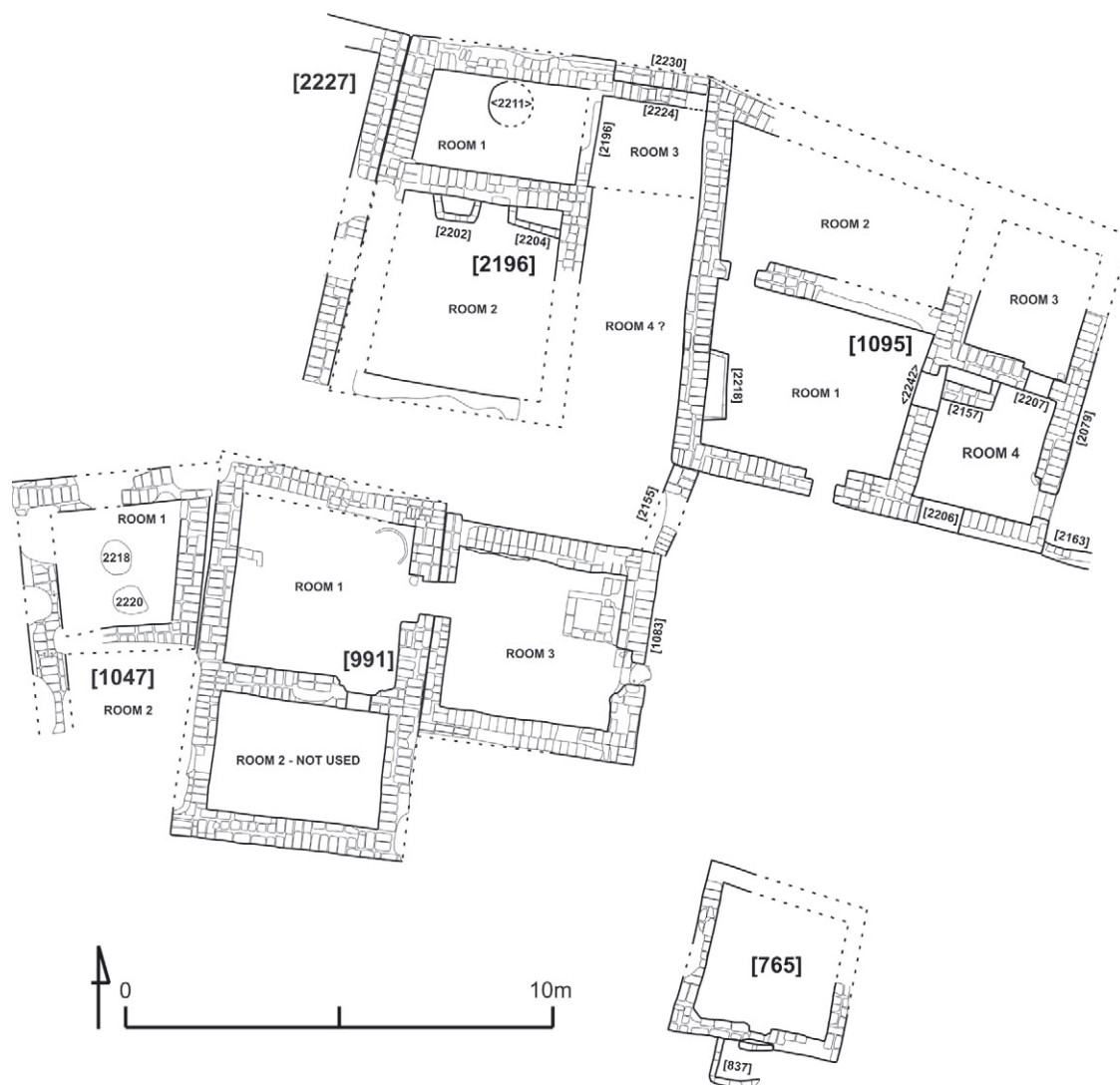

Fig. 73 Area 9, season 2016, plan of structures belonging to the Third Intermediate Period settlement, phase C2 (drawing Ł. Jarmużek)



Fig. 74 Building [1095], northern part covered by walls of building [2174] (phase B) (photo S. Rzepka)

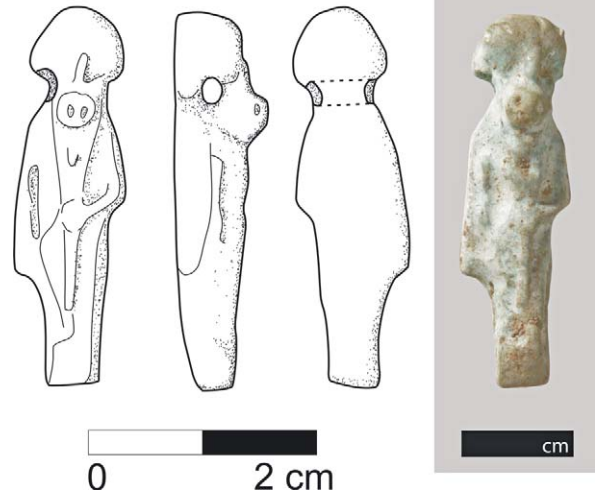
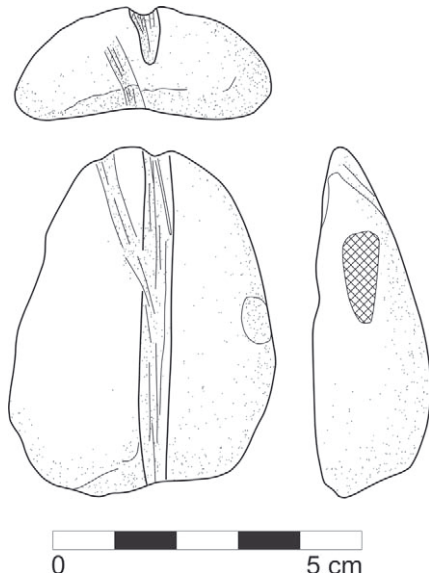

Fig. 77 Bastet or Sakhmet amulet S3108
(photo S. Rzepka, drawing L. Hulková)



Fig. 75 Loom weight S3107
(photo S. Rzepka, drawing L. Hulková)



Fig. 78 Bin [2157] and fireplace (2153) on floor (2116) in room 4

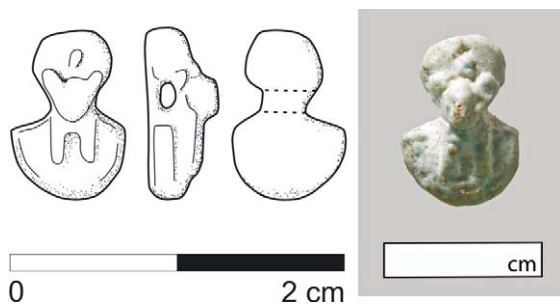

Fig. 76 Bastet or Sakhmet amulet S3054
(photo S. Rzepka, drawing A. Ryś)



Fig. 79 Blockage [2206] of the eastern entrance to building [1095] (photo S. Rzepka)

wall above it, whereas several burned bricks and soot observed on the eastern wall (Fig. 80) of the room had no counterpart in any traces of a fireplace on the floor surface. The layout of four spots of soot on the wall suggests two fireplaces. The spots are paired, two each, one above the other,

the gap between them probably the result of wall erosion caused by floor (2090) from phase C1 (see below). It seems rather unlikely that the upper soot spots were created during phase C1. A feasible explanation is for two pairs of fireplaces burning in exactly the same place in two occupation phas-



Fig. 80 Eastern wall of room 4 in building [1095] (photo S. Rzepka)

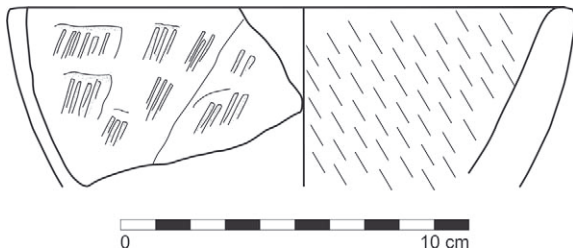

Fig. 81 Limestone bowl S3023
(photo S. Rzepka, drawing A. Ryś)

es, separated by a period of non-use (sub-phase 4, see below).

In room 3, a new floor (2114) appeared, consisting of a greyish brown layer with some ashes. The number of potsherds and animal bones was relatively insignificant. The small finds counted 10 artefacts: five fragments of stone vessels, two fragments of querns, two ceramic scrapers and one pounder. There was also a door-socket found *in situ* next to the eastern jamb of the doorway. Several bricks on the eastern wall bore traces of soot, but there was no clear layer of ashes below them.

The third sub-phase of building [1095] was relatively short-lived. The floor levels did not change

significantly. The main alteration was a blocked doorway between rooms 2 and 3, the blockage [2207] being made of rather regularly laid bricks. This was connected with the making of a new doorway between rooms 1 and 2. The cut <2242> in the wall between these rooms was 0.8 m wide. The doorjambes were probably on the side of room 2. This alteration in the connection between the rooms once again suggests that there was an entrance between rooms 2 and 3.

The fourth sub-phase marks an abandonment of the building [1095] for some time. Debris accumulated in all the rooms; these layers (2113), (2234), (2173) were about 20–30 cm thick and were composed of sand, fragments of mudbricks and ashes. Five fragments of a crude limestone bowl were found here; one of them (S3023) is shown in Fig. 81. Bowls of this kind are quite typical of the Third Intermediate Period contexts in Tell el-Retaba; more than 100 fragments have been found so far. They differ in size, but all show a similar, rather crude workmanship. Their outer surfaces are rough, often with visible traces of chiselling. Inside, the surfaces are often smooth, as if from frequent use.

5.3.3. Building [2196]

At the beginning of phase C2, the area to the west of building [1095] was still occupied by building [2147]. There was a 2.6 m wide passage between the two buildings (this area has not been completely excavated). After some time, the passage was



Fig. 82 Room 1 in building [2196] deposits of ashes with fragments of ceramic oven walls and fired mud bricks (photo S. Rzepka)

blocked with a wall [2230]. The level of the foundation of the wall is much higher than the level of the building walls on either side. When building [2147] fell out of use, most of its walls were taken advantage of in constructing building [2196]. The ground plan of building [2196] differed slightly. Rooms 1 and 2 were probably delimited by the

same walls as in the case of building [2147]. Room 3 was added where the passage between buildings [2147] and [1095] had once been. Another room may have existed to the south of room 4, an idea to be tested when completing the excavations in this area. Room 1 measured 2.2 m by 3.85 m.

Compared to room 1 of building [2147], the only change is a reconstructed eastern wall, which was much thinner now, measuring 0.3 m in width. It could have held an entrance to the room, but most of it is lost. The north-eastern part of the room was destroyed by a later cut. Other remains suggest the presence of an oven, although there is no trace of the installation itself. The room was filled with a 20–30 cm thick layer of ashes (2215), mostly grey, but also black and white. Fragments of fired mudbricks and ceramic body walls of an oven were found (Fig. 82). The ashy layer also contained several small finds, such as four fragments of stone vessels, two ceramic scrapers, two grinders, a whetstone and a loom weight. Moreover, a fragmentarily preserved rounded cut <2211> was found in the middle of the room. It was filled with a unit (2210) containing some fired sand and fired fragments of bricks. Similar rounded pits had been observed to constitute the lower part of an oven.¹²⁰ Room 2 was limited by the same walls as room 2 in building [2147], which means that it measured 4.35 m by 4.15 m. The oldest feature in the room was a rectangular bin [2204] in the north-eastern corner of the room. It measured 0.6 x 1.2 m and was preserved up to a height of two bricks. The bin was filled with layers of ashes (2203). Floor (2182/2205) inside the room accumulated already



Fig. 83 Fragment of an animal figurine S3071 (photo S. Rzepka, drawing L. Hulková)

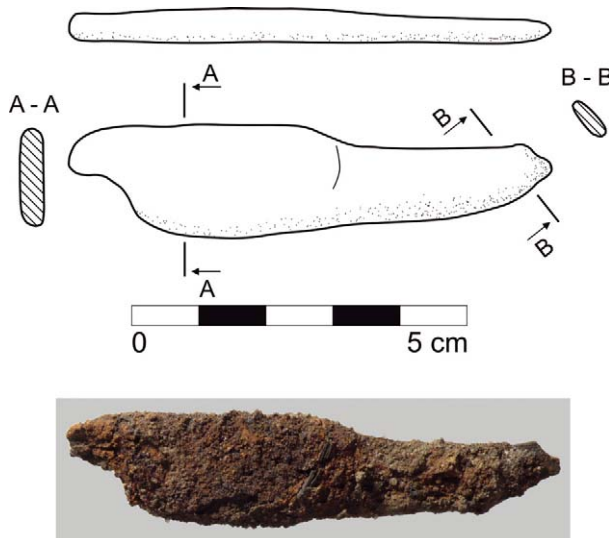

Fig. 84 Iron knife S3063 (photo S. Rzepka, drawing A. Ryś)

¹²⁰ RZEPKA *et al.* 2014, 128–130.



Fig. 85 Building [1047], abutting western wall of building [991] (photo S. Rzepka)

after the bin had been built. The floor was relatively thin; it did not contain a lot of potsherds or animal bones, but yielded several small finds: a fragment of a stone vessel, a quern, a pounder, a fragmentary bronze ring and a clay animal figurine (S3071, Fig. 83), preserved only as the head and neck, no ears or other details marked, the modeling too schematic overall to identify the species.

Another bin [2202] was built on the floor after some time. The bin measured 0.5 m by 1.1 m; two layers of brick were preserved. A layer of debris (2201) and a fragment of a quern were found inside it. The debris layer (2140), which later filled room 2, yielded an iron knife S3063 (Fig. 84).

Room 3 was created by adding wall [2224] between wall [2196] and the western wall of building [1095]. The room was 2.4 m wide and at least 2.24 m long. Its southern wall is not preserved. A fragmentarily preserved whitish-gray layer formed the floor (2195); it produced a small amount of pottery and animal bones, but no small finds.

5.3.4. Building [1047]

Building [1047] was first traced but not fully documented in the seasons 2011–2012;¹²¹ it was partly



Fig. 86 Group of bronze fragments found in room 1 of building [1047] (photo S. Rzepka)

excavated in 2016 (Figs. 73, 85). It abutted the western wall of building [991], the walls, however, being founded much higher than in the case of this latter building and following a different alignment. It is currently dated tentatively to phases C2 or C1. The overall ground plan of the building and of individual rooms is trapezoidal. The part of the

¹²¹ RZEPKA *et al.* 2014, 87.



Fig. 87 Vessel found on floor (2115) in room 1 of building [1047] (photo S. Rzepka)

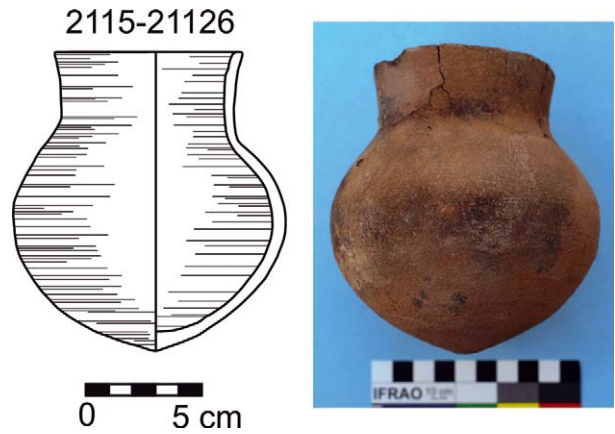

Fig. 88 Vessel found on floor (2115)

building excavated in season 2016 consisted of two rooms, but it is very probable that there are other rooms to the west. Room 1 measured 2.8 m by 3.0 m. No entrance to the room is in evidence; it was probably destroyed by one of the later cuts. Two floor levels were found inside the room. The older

floor (2121) was a whitish brown layer, containing some pottery, animal bones and ashes. It did not contain any small objects. A round patch of black ashes (2120) on the floor in the southern part of the room (cf. Fig. 85) yielded several shapeless fragments of bronze (S2933, Fig. 86) and a piece of a

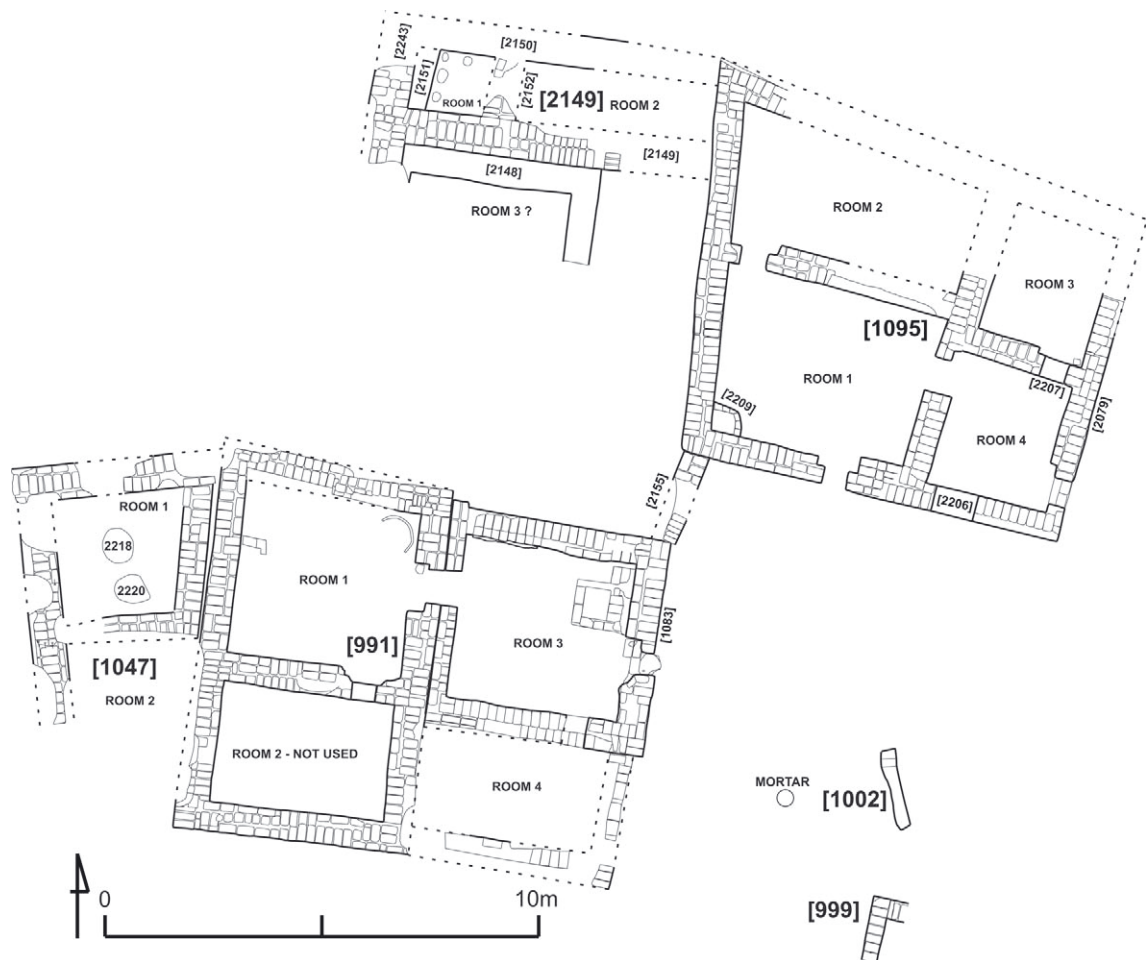

Fig. 89 Area 9, season 2016, plan of structures belonging to the Third Intermediate Period settlement, phase C1 (drawing Ł. Jarmużek)

ceramic vessel with bronze slag attached to the wall face.

A round cut <2119> found next to this layer, in the middle of the room, was about 0.27 m deep and 0.75 m in diameter. It was filled with a layer of sand mixed with grey ashes (2118) and an insignificant amount of pottery. Bronze objects from unit (2120) suggest bronze-working activities and the round cut may be interpreted as the remains of a kiln. In opposition to this theory, however, one may wonder why there are no ash layers filling it as is usually the case with ovens/kilns, and why there are no traces of burnt, brown soil typical of an oven/kiln around this cut. The excavation did not yield any furnace body pieces (a ceramic wall or baked mud from the upper parts), neither in the cut nor in the floor. The second floor (2115) in the room covered all the described features. The layer was partly destroyed by numerous later cuts. The floor was a cemented, whitish grey layer with a few potsherds and animal bones, and a fragment of a quern. A completely preserved pottery vessel was found in the south-eastern corner of the room (Figs. 87, 88). It is made of Nile B2 sandy fabric. The jar has a cylindrical neck, a slightly flaring round rim, a globular body and a pointed base, and a smoothed surface. Its shape and the material it was made of are very characteristic for the Third Intermediate Period. This type is a smaller version¹²² of larger forms, which often functioned as cooking pots, also typical for the period.¹²³ The small jar was a bit burnt. Traces of soot are visible especially on its neck and shoulder (Fig. 88b), proving that the pot was used in some heating activity.

The second room of the building was almost entirely destroyed by a big, modern cut.

5.4. Settlement (phase C1, Area 9)

Remains from phase C1 in Area 9 (Fig. 89), discovered in the seasons 2011–2012, demonstrated the continued use of building [991]. Another room was added to it. Two poorly preserved structures ([999] and [1002]) were found to the east of the building.¹²⁴

3.4.1. Open space between buildings [991] and [1095]

The location of structure [1002] suggests that the open space between buildings [991] and [1095] was probably made smaller in phase C1. Other remains were found in 2016 to prove that the space was used in a different manner. The area to the north-east of structure [1002] was covered with two layers (2088 and 2096) different than those found in phase C2. The units were the kind of greyish white, cemented layers that are often found inside rooms. However, in this case it is impossible to assign them to any closed structure. They abut the southern wall of building [1095], but the other boundaries have all been destroyed by modern cuts.

5.4.2. Building [1095]

Building [1095] was still in use during phase C1. Its general layout and the interconnection between rooms probably did not change from the last sub-phase of phase C2 (see above). New floors were found in all the rooms, on top of a layer of debris. Floor (2100) in room 1 was made up of a cemented, whitish grey layer covering almost the entire area of the room. The floor contained potsherds, animal bones and a relatively high number of small finds. Among them were eight fragments of stone vessels, two grinders, two fragments of flint tools, a bronze needle, and a limestone loom weight S3088, similar to the one shown in Fig. 75.

A fireplace [2209] was found in the south-western corner of the room. It was lined with at least two layers of bricks. The fireplace was filled with a layer of ashes (2208), in which another weight made of limestone was found (S3074, Fig. 90). It is quite different from S3088 and seems to be a net weight rather than a loom weight.¹²⁵

The last occupation of the room is marked by a layer of debris (2091) filling the room. This layer contained a relatively high number of small finds: six fragments of stone vessels, a grinder, a pounder and a fragment of a quern.

Floor (2090) in room 4 was a cemented, whitish grey layer. Several big pieces of pottery vessels were found on it and several small pieces of iron

¹²² ASTON 1998, 597, no. 2448.

¹²³ ASTON 2007, fig. 31, nos. 237–244 – 10th–9th century BC – and fig. 45–46 – 11th–10th century BC; WODZIŃSKA 2011, 1022, fig. 10.1–3.

¹²⁴ RZEPKA *et al.* 2014, 90–91.

¹²⁵ Cf. JARMUŻEK 2010.

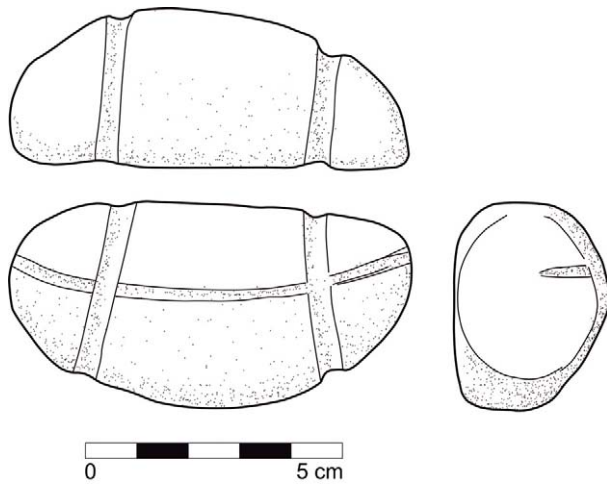

Fig. 90 Net-weight S3074 (photo S. Rzepka, drawing A. Ryś)

were embedded in it. Small finds from the floor comprised four fragments of stone vessels, three querns, two flint tools, a grinder and a fragment of a ceramic figurine S2909 (Fig. 91). It shows a quadruped, probably a horse. Horse figurines were certainly present in Tell el-Retaba, as confirmed by S2866 (Fig. 92); this object was found in disturbed surface layers, without a clear archaeological context.

The base of a middle-sized jar made of Nile B2 fabric with smoothed surface was found most probably *in situ* in the middle of the floor (2090) inside the room (Figs. 93, 94.1). It is not clear how the jar was used, but it may have been as a storage container. Near the base there was also a small jar handle (Fig. 94.2). It was made of Nile E fabric and well smoothed. A number of small notches were made after firing on the inside of the handle. This was either because the vessel was suspended by the handle or it may have been used for textile production, for example spinning.

Floor (2093) inside room 3 corresponded to the same type of layer in other rooms. A faience ring and a crude limestone bowl (S2907, Fig. 95) were the only finds from this layer. Six more bowls of the same kind, among them S2867 (Fig. 96), were

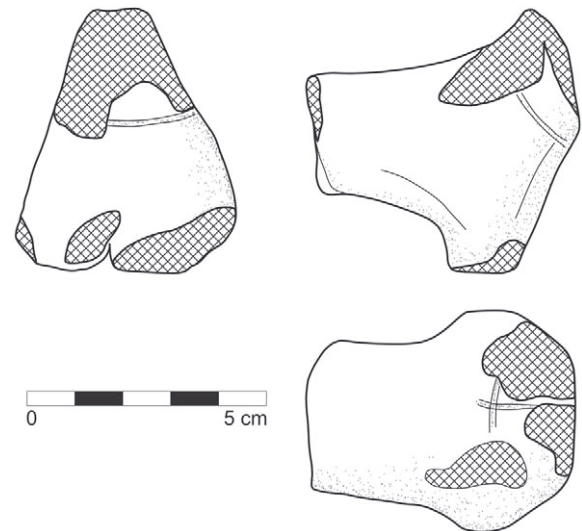

Fig. 91 Fragment of an animal figurine S2909 (photo S. Rzepka, drawing A. Ryś)



Fig. 92 Fragment of a horse figurine S2866 (photo S. Rzepka)

found in the debris layer (2070), which covered building [1095] when it was finally abandoned.

It is noteworthy that all the floors described above were created approximately 0.4–0.5 m above the original foundation level of the building. The height of the walls from phase C2 can, of course, not be determined, but it seems very likely that the roof level in phase C1 must have been raised.



Fig. 93 Base of a jar (2133), in situ in the middle of floor (2090) in room 4 in building [1095] (photo S. Rzepka)

Finds from the deposits that accumulated over the ruins of building [1095] included a small peculiar limestone figurine (S2856, Fig. 97) from debris layer (2070). It is quite schematic but it might depict a sitting person. Short hands and legs are clearly recognisable. The figurine has a large, round belly and a small head with two eyes, a big nose and an open mouth. Another faience amulet in the shape of Bastet/Sakhmet (S2905, similar to the one shown in Fig. 77) was discovered in the ash dump layer (2071). A bronze needle (S3065, Fig. 98) and a bone pin (S2887, Fig. 99) were found in another ash deposit (2083).

5.4.3. Building [2149]

Remains from phase C1 in the area west of building [1095] were relatively not well preserved. Building [2196] from phase C2 went out of use. Building [2149] was built in its place. The building consisted of new walls ([2149], [2152], [2243]) added to old walls ([2148], [2150], [2151]) from previous phases (Figs. 89, 100). The building comprised at least two rooms. The layout of room 1 is quite

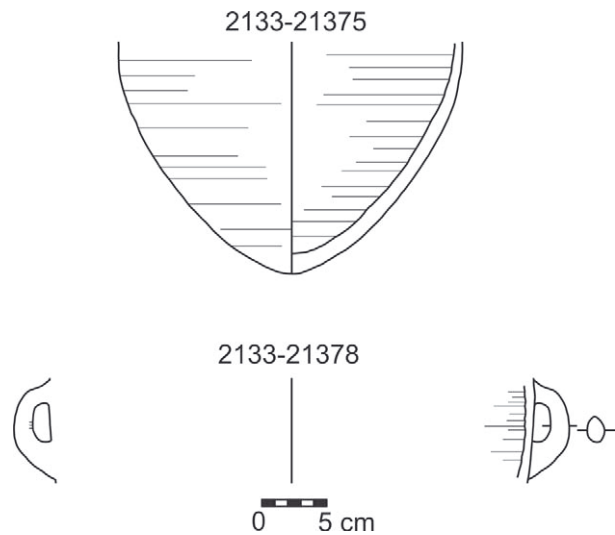

Fig. 94 Jar (2133) and a small jar handle found nearby

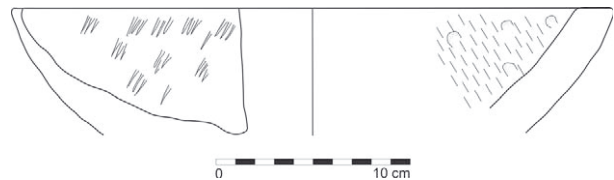

Fig. 95 Limestone bowl S2907 (drawing A. Ryś)

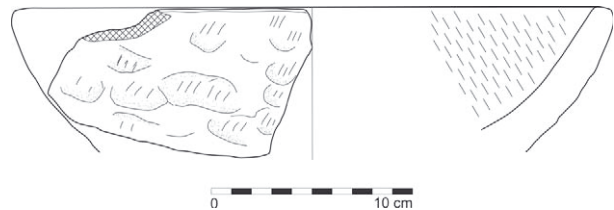

Fig. 96 Limestone bowl S2867 (drawing A. Ryś)



Fig. 97 Figurine S2856 (photo S. Rzepka)

unclear. It was limited by wall [2149] from the south, wall [2152] from the east, wall [2150] from the north and wall [2243] from the west. However, the deposits inside the room indicate that the old wall [2151] was still standing, at least to a certain height, in the western part of the room. Two layers

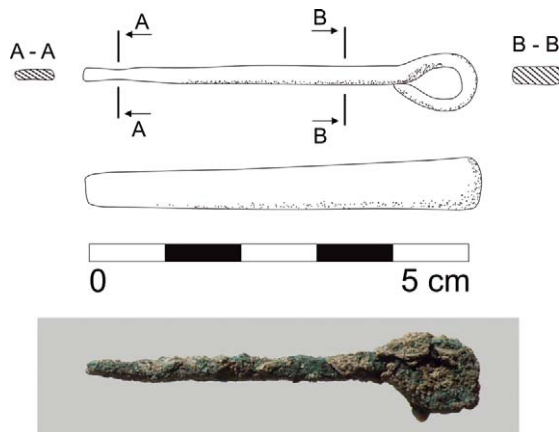

Fig. 98 Bronze needle S3065
(photo S. Rzepka, drawing A. Ryś)

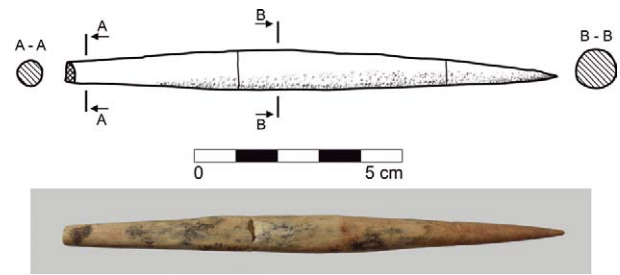

Fig. 99 Bone pin S2887 (photo S. Rzepka, drawing A. Ryś)



Fig. 100 Room 1 of building [2149] (photo S. Rzepka)

of loose, grey ashes were found inside the room. These layers abutted the eastern face of wall [2151], proving that the wall must have been used, maybe as some kind of mastaba. The lower layer of ashes (2168) contained several large fragments of pottery. The base of a large jar (Figs. 101,102) was found there, probably *in situ*. It was made of Nile B2 fabric. The external surface was covered with a light red slip and well smoothed. The base probably belonged to a large storage jar. Three

fragments of bowls with flaring rims, made of Nile B2 fabric with smoothed surfaces, were found nearby. Their shapes are very characteristic of the Third Intermediate Period,¹²⁶ they are also very well known from Tell el-Retaba.¹²⁷ After some time, these vessels were covered with another layer of ashes (2141). Rooms 1 and 2 may have been connected by a doorway in wall [2152], but the wall was so badly destroyed by a later cut that it is impossible to determine the location of the door-

¹²⁶ See ASTON 1999, e.g. 50–51, also 65, 69; ASTON 2007, 34, fig. 29; BAVAY 1998, 323–324, fig. 34.38–39.

¹²⁷ WODZIŃSKA in RZEPKA *et al.* 2009, fig. 30.7–8.



Fig. 101 Ash deposit (2168) with large fragments of pottery, in room 1 of building [2149] (photo S. Rzepka)

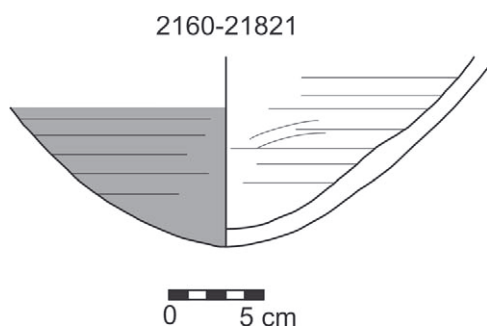

Fig. 102 Base of jar (2160) found in room 1 of building [2149]

way. Room 2 was 1.4 m wide and at least 2.5 m long. The eastern wall of the room is not preserved. It is possible that the wall abutted the western wall of building [1095]. Layers inside room 2 were destroyed completely by a later cut. The fact that wall [2148] was still preserved may suggest that there was another room to the south of this wall. However, no traces of floors or installations belonging to building [2149] could be observed.

5.5. Conclusions

Excavations conducted in the 2015–2016 seasons contributed new data on the settlement from the Third Intermediate Period in Tell el-Retaba. The settlement in phase C3 consisted of at least four buildings. Their layout seems to be quite regular. The buildings were placed in three rows separated by two 2–3 m wide streets and were all aligned in the same direction. Buildings [2147] and [991] were very similar. Both measured roughly 9 m by 5 m and had two rooms. The habitable area in each of the buildings was about 26 m². The area to the

east of both buildings seems to have been free of large structures.

In the next phase there were at least six buildings in this part of the settlement. Two buildings from the earlier phase were modified. In the case of building [991] one room was added on its eastern side, while another one fell out of use. In effect, the general layout of the building was changed, but the habitable area (31 m²) remained roughly the same. Most of the walls of building [2147] were used in constructing building [2196], which was larger, with at least 32 m². Two new buildings ([1095] and [765]) were built in the eastern part of the excavated area. Building [1047] was raised to the west of building [991]. Building [1095] with its habitable surface of about 50 m² is for now the largest structure in the area. The streets between buildings [991], [2196] and [1095] were blocked during this phase.

In phase 3 most of the structures from the earlier phase were still in use. The walls of building [2196] were used to construct building [2149]. Its layout is very obscure. The general layout of building [1095] remained the same. Building [991] was modified once again. Adding a new room enlarged the habitable area to 41 m².

During all the phases of the Third Intermediate Period there were buildings comprising two to four rooms in the excavated section, their habitable area varying from 26 to 50 m².

6. Late Period

6.1. Settlement (phase B, Area 9)

LJ, AW, SRz

Before the 2016 season the Late Period was attested in Tell el-Retaba only by some pottery found on the surface or in cuts. This sufficed to question the widely voiced assumption that Tell el-Retaba was deserted during the Late Period, its population having moved to the nearby Tell el-Maskhuta.¹²⁸ It could be assumed that the site was not completely deserted during this period, but without architectural remains, it was not possible to ascertain the character of this occupation: was it a thriving city or a small, poor settlement of squatters living in the ruins of the Third Intermediate Period settlement? In the parts of the tell excavated between 2008 and 2015, the Late Period architectural remains were completely obliterated by erosion. In

¹²⁸ Cf. REDFORD 1982, col. 1055; GOEDICKE 1986a; 1986b.

2016, for the first time Late Period strata with substantial architectural remains of three large buildings were excavated.

6.1.1 Building [2191]

Building [2191] was found in the northern part of the excavation trench (Figs. 103, 104). Only the tops of walls were cleared and documented. It seems at present that the building consisted of four rooms. It was 16.3 m long and 9.7 m wide. Wall thickness varied between 0.8 and 1 m. Room 1 in

the eastern part of the building measured 3.3 m by 4.8 m. No entrance to the room has been located yet. Room 2 was probably L-shaped in plan, 3.5 m by 7.9 m in size. There were at least two other rooms in the western part of the building. It seems that there were also two entrances in the western wall of the building. The northern entrance led to room 3. The southern entrance led to room 4, which measured 2.5 m by 2.5 m. An entrance leading to room 3 was probably cut into the eastern wall of room 4.

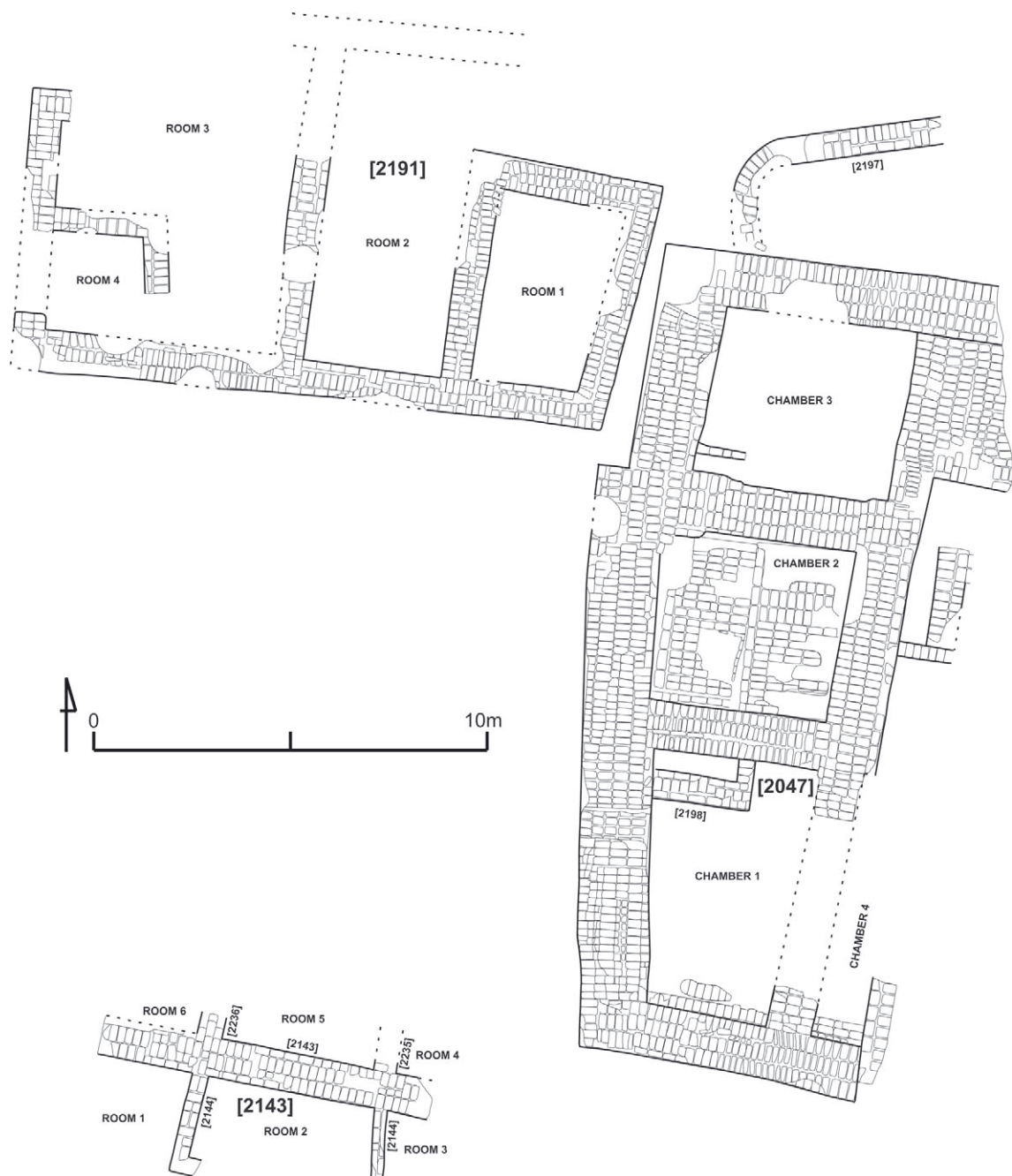

Fig. 103 Area 9, season 2016, plan of structures belonging to the Late Period settlement, phase B (drawing Ł. Jarmużek)



Fig. 104 Building [2191] (photo S. Rzepka)

6.1.1 Building [2074]

Building [2074], which was only partly excavated, was situated to the east of building [2191] (cf. Fig. 103). The building was about 20 m long and at least 10.5 m wide, but the eastern limit of the structure has yet to be located. The architectural features of the building indicate that it was a tower house.¹²⁹ Very thick walls (up to 1.8 m) allowed a very high building to be constructed. The walls formed a casemate structure, that is, closed chambers without doorways between them. Casemates were often used to create a solid foundation for tower houses. In the case of building [2047] there were at least four chambers. Chamber 1 measured 3.1 m by 6.6 m and was roughly trapezoidal in plan (Fig. 105). Wall [2198] in the north-western corner of the chamber enclosed a small space filled with ashes (2102). Several brick courses were found next to the southern wall of the chamber. The bricks were covered with layer (2082), composed of sand and ashes. Most of the chamber and its eastern wall were destroyed by a huge modern cut. After removing the wind-blown sand filling, the bottom levels of walls surrounding chamber 1 were exposed, revealing differences of up to one metre. These were due to some parts of the walls being constructed on top of the ruins of earlier

structures, while other parts cut into old structures. Chamber 2 was roughly square in plan; it measured 4.4 m by 4.70 m. Almost the entire area of the chamber was covered with regularly laid bricks (2123) (Fig. 106). Further excavations will show whether there are more courses of bricks. The layer of bricks was covered with an ash layer (2099) containing some potsherds. The whole deposit (34 fragments of pots) can be dated to the Late Period, but it consists mostly of TIP sherds (27 in total). Therefore, it seems secondary and not directly associated with the use of this space. However, seven sherds can be dated to the Late Period, thus dating the structure. Two of the Late Period sherds are shown in Fig. 107. The first is a large vase made of Nile C fabric with a thick narrowing rim (Fig. 107.1). The pot can be associated with the 27th Dynasty.¹³⁰ The second is a flaring rim of a large jar (Fig. 107.2) made of Nile B2 fabric and well smoothed. The type seems similar to “les jars de grande taille” from Tell el-Herr.¹³¹ The layer (2099) also contained some animal bones and several small finds: two polishers, two ceramic discs, a grinder, a fragment of a stone vessel, a whetstone, and two beads made of glass. Chamber 3 (Fig. 108) measured 4.2 m by 4.8 m. Inside the chamber, a sandy layer (2190) has started to be excavated. It contained some potsherds and two

¹²⁹ ARNOLD 2003, 170–193; MAROUARD 2014.

¹³⁰ ASTON 1999, 220, 223, pl. 68, no. 1970.

¹³¹ DEFERNEZ 2001, pl. 16.



Fig. 105 Tower house [2074], chamber 1 (photo S. Rzepka)



Fig. 106 Tower house [2074], chamber 2 (photo S. Rzepka)

fragments of stone vessels. Chamber 4 was mostly destroyed. It was relatively narrow, being only 1.3 m wide. The area east of chamber 2 was cleared only on the surface. Two walls in this area suggest that there was another chamber there. In the case of the area east of chamber 3, it is still not clear whether it was covered by a layer of bricks or the eastern wall of the chamber was so thick. Wall [2197] was found directly to the north of the building (cf. Figs. 103, 108). The eastern part of the wall was straight, the western part was rounded and abutted the northern wall of building [2074]. The wall probably defined a courtyard connected with the building. Similar casemate structures of tower houses, dated to the Late Period, are known from

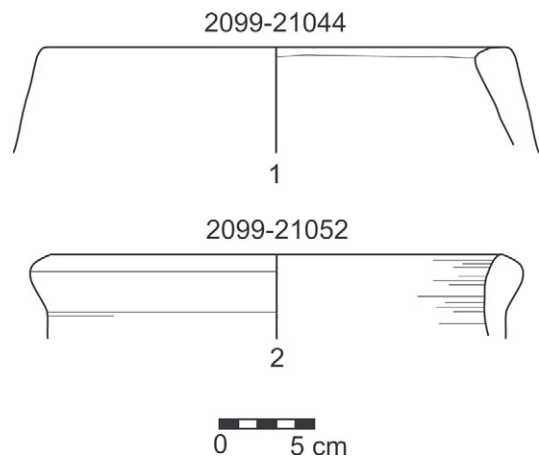

Fig. 107 Vessels from layer (2099) dated to the Late Period



Fig. 108 Tower house [2074], chamber 3 (photo S. Rzepka)

several sites in the Nile Delta, like Tell el-Dab^a¹³², Buto¹³³, Tell el-Muqdam¹³⁴ and Tell el-Ghaba.¹³⁵

6.1.1 Building [2143]

Building [2143] was situated 3.5 m to the south-west of building [2074]. The destruction of the upper layers of the site in the area have led to the loss of all direct stratigraphic relations between the buildings. The state of preservation of building [2143] was also very poor. Several fragmentary walls were uncovered (cf. Figs. 103, 67). These walls were constructed in a manner similar to the walls of chamber 1 in building [2074] (see above); in some parts bricks were laid directly on top of debris from the Third Intermediate Period and in other parts foundation cuts were made. The purpose of this building technique is rather obscure, because the foundation levels of walls were still irregular and builders were forced to level brick courses using irregular bonding patterns. The preserved part of the building consisted of one thick wall and four thinner walls. The thick wall [2143] was preserved for a stretch of 8.5 m, being about 1 m thick. Two thinner walls [2235] and [2236] were found on the northern side of the thick wall, both were probably 0.6 m thick.

Walls [2144] and [2146] discovered on the southern side of the thick wall were 0.3–0.4 m thick. The walls set off at least six rooms of building [2143]. However, there were no layers which could be linked with the occupation of these rooms. The lack of archaeological material and direct stratigraphic relations with other structures from the Late Period makes the dating of this structure uncertain.

The number of small finds from the Late Period context is still limited, owing to the fact that excavations of the above described buildings have just begun. However, artefacts from the disturbed top layers above the Late Period ruins should be dated to this period. Among them are two faience amulets, one in the form of a falcon (S3032), the other showing a seated jackal (S3142). Another example is a ceramic furniture piece in the form of the leg of a low stool or table (S2972).

6.2. Third Intermediate Period and Late Period remains (phase B-C, Area 7)

VD

Only several parts of Late Period mud brick walls (e.g. [1678], [1681], [1704], [1708]) could be traced

¹³² LEHMANN 2011; 2012.

¹³³ HARTUNG *et al.* 2003, 211–219; HARTUNG *et al.* 2007, 120–126; HARTUNG *et al.* 2009, 115–128.

¹³⁴ REDMOUNT and FRIEDMAN 1997.

¹³⁵ LUPO 2015, 63–95.



Fig. 109 Terracotta plaque S2112
(photo L. Hulková, drawing L. Kováčik)

in Area 7 and many upper layers were rather mixed with modern material coming from the surface of the site. However, the finds testify to the intensive occupation of the site during later peri-

ods. Some remarkable objects were found within layers covering the New Kingdom structures in Area 7, which could be dated by these objects to the Third Intermediate Period (TIP) and Late Period (LP) occupancy.

6.2.1. Terracotta plaque

One of the important finds is a fragment of a relief-decorated terracotta plaque (S2112), found in (1701) (Fig. 109) in square Y95X115. It represents a naked female figure¹³⁶ with a short locked hairdo or wig, with her arms straight beside her body, flanked by two papyrus plants. She stands in front of a rectangular base with an Egyptian-like cornice creating a kind of shrine, or a temple façade, behind her.

Related to the earlier so-called Astarte-plaques, appearing mostly in the LBA Palestinian sites (domestic as well as funerary), from the 15th–11th century BC, these plaques with female figures in front of the temple façades were still popular at the beginning of the Iron Age (11th–8th century BC).¹³⁷ Unlike the widely distributed Egyptian New Kingdom female figurines (‘Concubines’),¹³⁸ these items represent figures with diverse divine attributes (hairdo and headwear, plants, and animals) and are mostly identified as the goddesses Astarte, Anat, Ashera or Qudshu.¹³⁹ This group of plaques come either from Egypt, mostly bought at a market in the area of Memphis, or from the area of Gaza.¹⁴⁰ Combining Egyptian and Palestinian elements, they could be manufactured in both areas.¹⁴¹ The piece from Tell el-Retaba so far represents the only known Egyptian piece coming from regular excavations and from a clear Late Period context.

6.2.2. Zoomorphic figurines

Another clay object (S2149) was found in layer (1701), dated to the Late Period, in Y95X115 and two others (S2117, 2150) were discovered by surface cleaning in Y105Y105. All three represent clay zoomorphic figurines or vessel appliques in the shape of quadrupeds, probably horses (originally with horsemen?) or bulls.¹⁴²

¹³⁶ PETRIE 1909, 16, pl. XXXV, no. 7; ROTTÉ 2012.

¹³⁷ MAZAR 1985; CORNELIUS 2004, esp. 62–67; PETRIE 1906, 33:45 (‘probably foreign made figures dated to 1000–800 B.C.’), pl. XXXVI, no. 20.

¹³⁸ See e.g. GIDDY 1999, 28–42, pls. 7–12.

¹³⁹ CORNELIUS 2004, 89–101.

¹⁴⁰ MAZAR 1985, especially compare nos. 2, 3, 7, fig. 20.

¹⁴¹ Mazar has suggested the Phoenician quarter in Memphis as the probable production place of the Egyptian items: MAZAR 1985, 16.

¹⁴² DUNCAN and PETRIE 1906: from Yehudiyeh, pl. XIXD, also from Tell el-Retaba: pl. XXXVI: 20; JAMES and MCGOVERN 1993, figs. 92–93 (from Level VII).

6.2.3. Amulet

A fragment of a Late Period faience amulet in the form of a male standing figure (S2194),¹⁴³ depicting most probably a male god (Thoth, Khnum or Re-Harakhty), was found in a mixed context during the site surface cleaning in square Y95X115.

7. Ottoman Period (phase A, Area 9)

AW

An unusual find dated to the Ottoman Period was discovered in the area of building [2074]. A rounded cut <2128> was recorded in the north-western corner of chamber 2 (cf. Fig. 106). The cut was



Fig. 110 Cut <2128> from the Ottoman period (photo S. Rzepka)

about 0.4 m deep, its diameter being approximately 1 m (Fig. 110). It was filled with layer (2127), consisting mainly of sand and ashes. In it were large fragments of several pottery vessels from Ottoman times, but all in disturbed position, on their side or upside down.

The deposit contained three handmade closed vessels and five wheel-made jars. All of them were heavily used and extremely fragile, making any reconstruction of the form quite difficult. The three handmade vessels were made of Nile fabric



Fig. 112 Heavily burned rim fragments of hand made vessel (no. 2181-22416) from Ottoman deposit

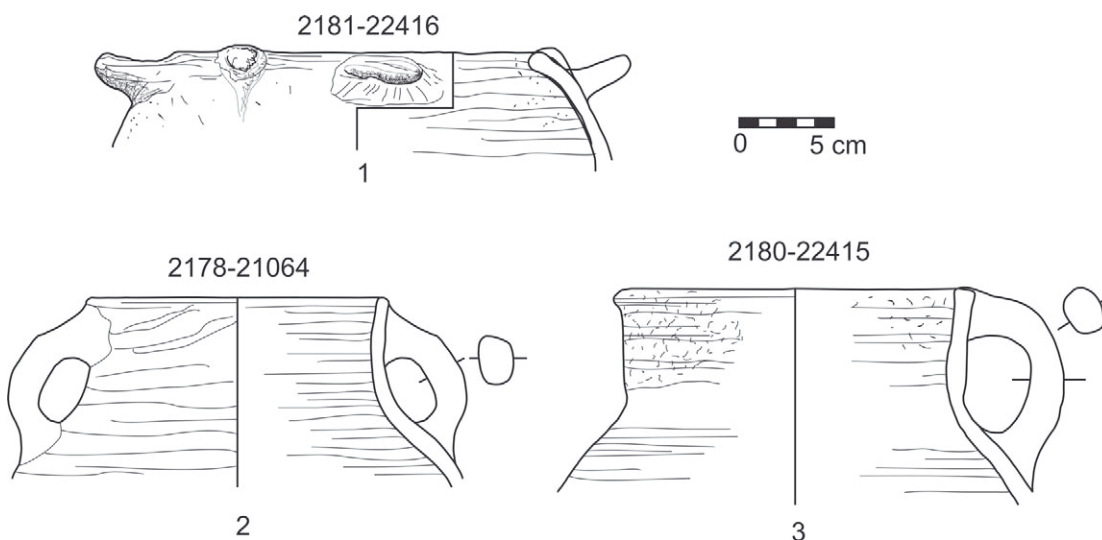

Fig. 111 Hand made vessels from Ottoman deposit

¹⁴³ PETRIE 1914, 40–42, pl. XXXIII:183, 187, pl. XXXVI:202; also compare Thoth amulets from the Metropolitan Museum: Acc. No. 96.21.1, 04.2.370: <http://www.metmuseum.org/art/collection/search/552980> (24.3.2017); Khnum: Acc.

No. 44.4.23. Late Period amulets depicting similar deities were already found by Petrie at Tell el-Retaba: DUNCAN and PETRIE 1906, pl. XXXII.

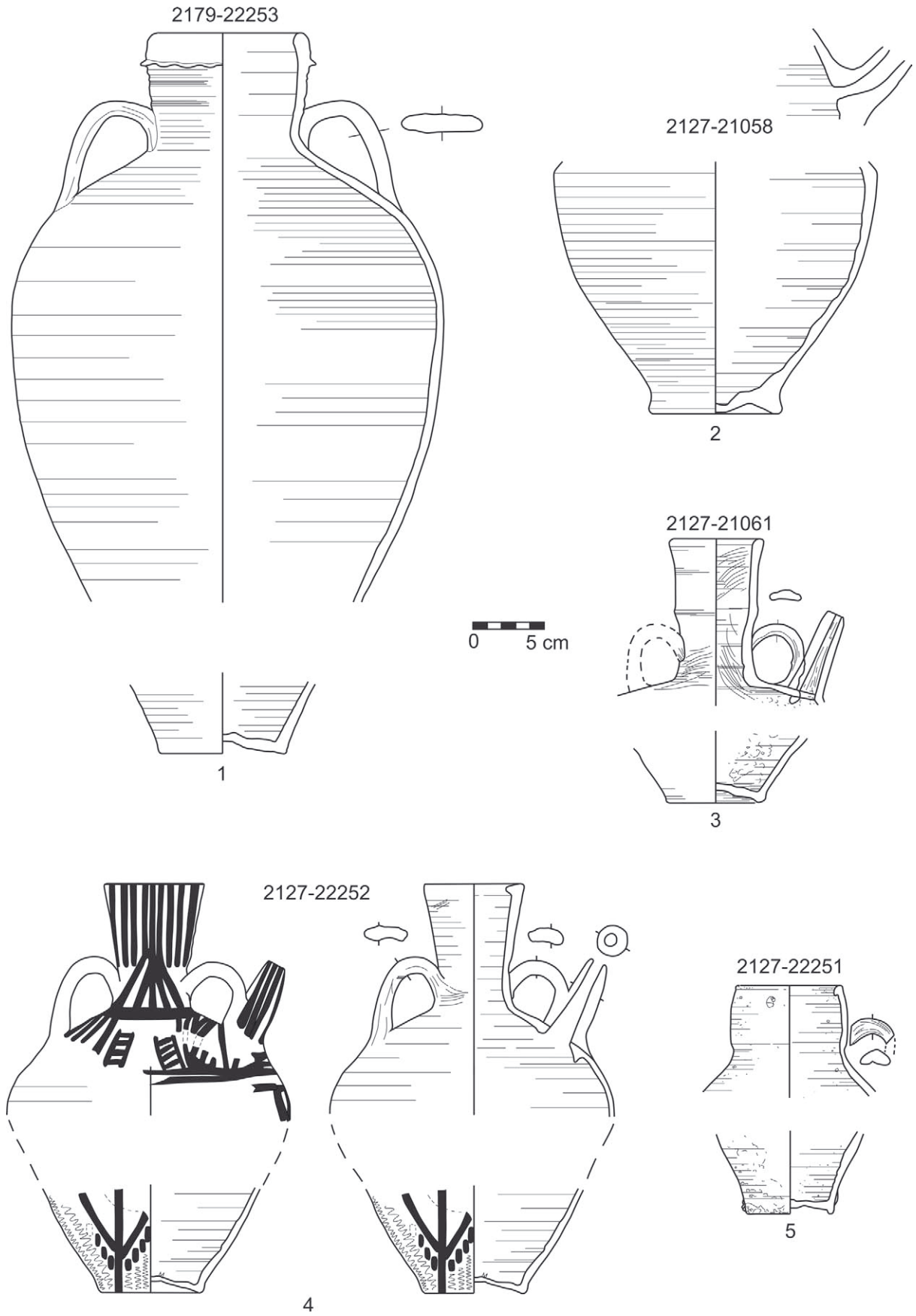

Fig. 113 Wheel-made vessels from an Ottoman deposit



Fig. 114a–b One of the juglets, from an Ottoman deposit (see the pot drawing in Fig. 113.4.)

with distinctive grog inclusions. Even if not very well made, they bear evidence of good treatment; their bodies were well burnished. All of them were much burnt and are covered with soot. The three pots are of different shape, although it seems that they shared a round base. One of the pots was a

vase without neck, with a narrowing rim and at least two ledge horizontal handles attached to the rim (Figs. 111.1, 112). There was also a conical knob applied to the external surface near the rim. The next handmade pot was a jar with two handles and round slightly flaring rim (Fig. 111.2). There was also a jar with only one handle and a flat rim flaring at the top (Fig. 111.3).

The wheel-made vessels include an ovoid jar with two loop handles, cylindrical neck, round rim and ring base (Fig. 113.1). A wavy ledge slightly below the rim renders a somewhat decorative appearance. It was fired in reduced atmosphere, making the surface and clay in the break grey. The jar is probably an early version of the so-called Ballas jar¹⁴⁴ well known in modern Egypt.¹⁴⁵ The second wheel-thrown pot is a jar with biconical body, ring base and spout (Fig. 113.2). Its rim is not preserved, but it seems that it is a *qulla* or a jar for water. It is made of dense and homogeneous material and is covered with white slip. The assemblage also included three juglets, each with a long rim, two handles, a low ring base and one spout (Figs. 113.3–5, 114). Even if made of the same homogeneous Nile fabric, they seem to be produced in different workshops, because their shapes vary in the details, especially of the rims. One of them was also very nicely decorated (Figs. 113.4, 114a). The pattern was probably made by a potter running his finger on the still wet surface of the juglet. The juglets can be called *abriq*, that is, kettles used for boiling¹⁴⁶ or for ablution,¹⁴⁷ still in use in some parts of Egypt. They all contained remains of the original contents, most probably tea dregs (Fig. 114b), so in this context the juglets were rather not used for ablutions. The best parallels from the Ottoman period come from Quseir.¹⁴⁸

The Ottoman pottery was found in a hole in the ground without any traces of architecture. The arrangement and selection of pots suggests that even without stable structures, the site of Tell el-Retaba was used on some permanent terms. More research is still needed, but the Ottoman pottery can probably be connected to the Bedouins. Ottoman material in general is known from Tell el-Retaba and can be dated to the late 18th century AD, especially the clay pipes¹⁴⁹ and the handmade pottery.¹⁵⁰

¹⁴⁴ LE QUESNE 2007, 226, fig. 89.

¹⁴⁵ NICHOLSON and PATTERSON 1985, 237, fig. 8.

¹⁴⁶ HENEIN 1997, 156, fig. 91.

¹⁴⁷ HENEIN 1992, 12; 1997, 155, fig. 90.

¹⁴⁸ LE QUESNE 2007, 202, fig. 77.

¹⁴⁹ SÓJKA in RZEPKA *et al.* 2015, 140–143.

¹⁵⁰ WODZIŃSKA in RZEPKA *et al.* 2015, 149–150, fig. 79.2–9.

APPENDIX: LAND SURVEYING AT TELL EL-RETABA

Eva Stopková

Abstract: The chapter summarises the contribution of proper land surveying practise and spatial data management to the sustainability of the archaeological excavations at Tell el-Retaba. Among the crucial tasks in the surveying work, the Survey Control Network establishment must not be underestimated to prevent the loss of spatial information on the site, especially if located in the local coordinate system. Effective data development, including recording the metadata, provides not only the information on the current state of the site, but also a valuable basis for further spatial analyses.

Keywords: Land surveying in Archaeology, Survey Control Network, Spatial Data, Spatial Analyses

Land surveying, as an inherent part of archaeological research, provides substantial materials to the exploration of spatio-temporal dynamics of the excavated site. The Site Plan and detailed maps of stratigraphical layers or small finds contribute to the proper description of a fading past, but moreover, they represent a unique method of archaeological interpretation. The importance of current modelling techniques, which enable to develop diverse graphical representations of the finds in reference to the spatial framework, has already been highlighted¹⁵¹, not to mention numerous case studies. A geospatial approach allows to connect visual, verbal and spatial information into a comprehensive basis for deriving knowledge about hidden relationships between the objects, using statistical, analytical and geospatial skills. However, the application of these advanced toolboxes for analysing the features from a completely new standpoint requires a careful preparation of the fine data based on a reliable framework, as outlined in this chapter.

1. Survey Control Network establishment

Mapping in general is based not just on appropriate surveying techniques and specific professional

abilities, but a reliable reference frame means a crucial condition for sufficient spatial data creation as well. However, the Global Navigation Satellite Systems (GNSS) have never been used at Tell el-Retaba. Since the Polish-Slovak project started at Tell el-Retaba in 2007, all the surveying work has been performed in a local coordinate system fixed by control points on the footings of electric masts. Before the season of 2014, the masts had been reconstructed and the control points were discarded, as proven by positional differences of 40–70 cm between the original and the current measurements.

A new benchmark was established using a geodetic network adjustment based on a terrestrial approach. The first professional geodetic work since 2007 consisted of testing different combinations of observables in the *Gauss-Markov model* and the *Gauss-Helmert model*¹⁵² to fix the core network, checking several methods of spatial transformation to reach an optimal approximation of the original local coordinate system, the estimation of coordinates of the additional points in geodetic networks of the 2nd and the 3rd epoch to improve accessibility and to increase the diversity of control points, and backup points establishment in the southern part of the site, in case of future SCN demolition. All the issues mentioned above emerged in *MathCAD*¹⁵³ scripts developed by E. Stopková in the past, as a deep understanding of the source codes was necessary to perform modifications to make the modules eligible for the complicated situation at Tell el-Retaba.

A reliable and precise geodetic network, after two complex revisions in order to eliminate disruptive influences of harsh terrain and eroded identical points, provides a robust reference frame for further surveying work at the site. The precision of horizontal coordinates achieves 3 cm on average, the precision of vertical coordinates achieves 1 cm. The compliance between the structures measured currently and in the past makes the mean of differences 6 cm, with 90% quantile

¹⁵¹ REMONDINO and CAMPANA 2014.

¹⁵² KUBÁČKOVÁ, KUBÁČEK, KUKUČA 1987.

¹⁵³ PTC 2017.

of 10 cm; in the revised version from 2015 it used to be 15 cm on average with 90% quantile of 20 cm.¹⁵⁴ A computational protocol is included in the technical report.¹⁵⁵

Except for the scientific work around the adjustment, the control points fixation required the recalculation of the whole spatial data acquired and a redrawing of the plans, especially from 2014. During the season 2014, all the measurements were performed in a shifted coordinate system, as the complex control points restoration required a large amount of time and waiting for the complete recovery would have significantly disrupted the time schedule of the mission.

2. Spatial data creation and management

The newly established *SCN Retaba 2014* became a new framework for mapping the site, stratigraphic layers, small finds, control points for photogrammetric modelling etc. Tacheometric surveying for horizontal positioning and trigonometric levelling to obtain the elevations were performed using total stations *Trimble M3*, SN D046056 (2014, 2015), *Leica TCR 407 power R100*, SN 835687 (2014) and *Leica TS11*, SN 1625319 (2016). Although these instruments achieve a high precision, real accuracy of spatial data may vary depending on the period of the day (direct sunlight and refraction), stability of the ground or atmospheric conditions (wind, dust in the air).

CAD drawings,¹⁵⁶ based on the lists of three-dimensional coordinates in the local coordinate system, provide an appropriate background for further spatial and archaeological analyses. The casual content consists of a graphical representation of the excavated features, labelled with elevations of the points and stratigraphic unit numbers for better orientation. A tool for more effective data creation has been developed and described.¹⁵⁷

A large amount of measured data requires a reasonable management as well. It seems to be essential to keep detailed daily records of the measured features. Well sorted information contributes to a better orientation in the data in case of necessary changes (e.g. stratigraphic unit edits) or further requests for detailed map preparation. Experience has proven that even random events on the site, such as a discharged battery, should be recorded because this kind of information may be helpful for problem solving in the future. Above all, a surveying journal (preferably both analogue and digital) tracks the whole process of mapping, prevents from losing data and related information, and helps to understand and manage the work not just to the author, but also to his/her followers even after some years.

3. Spatial analyses and further research

As mentioned above, spatial analysis can result in an adequate outcome, but only under the condition of sufficient input. The years 2015 and 2016 have been dedicated to the recovery of the lost spatial information at the site and to the optimisation of the spatial data management. However, a preliminary digital elevation model (DEM) of the site, based on the provisional amount of input points, was calculated for the purpose of comparison of the gravel elevation with the terrain.¹⁵⁸ Currently, a high-resolution DEM is being prepared using the measurements from 2015. Geomorphological analyses of the final product are supposed to indicate the existence of undiscovered structures at the site; in case of a negative result, at least already known, but unexcavated structures will be modelled and visualised. The analytical work continues with satellite images to monitor temporal changes of the *tell* and with spatial analyses of three-dimensional digital models of the finds *in situ*.

¹⁵⁴ More detailed information on the geodetic network adjustment, statistical testing and empirical verification is available in STOPKOVÁ in review.

¹⁵⁵ STOPKOVÁ 2016a.

¹⁵⁶ STOPKOVÁ 2016b.

¹⁵⁷ STOPKOVÁ 2016c.

¹⁵⁸ HUDEC, FULAJTÁR, STOPKOVÁ 2015.

Bibliography

- ARNOLD, F.
2003 *Elephantine XXX: Des Nachnutzung des Chnumtempelbezirks*, AV 116, Mainz am Rhein.
- ASTON, B.G., HARRELL, J.A. and SHAW, I.
2000 Stone, 5–77, in: NICHOLSON and SHAW (eds.) 2000.
- ASTON, D.A.
1998 *Die Keramik des Grabungsplatzes Q I, Teil 1, Corpus of Fabrics, Wares and Shapes*. FoRa 1, Mainz am Rhein.
1999 *Elephantine XIX: Pottery from the Late New Kingdom to the Early Ptolemaic Period*, AV 95, Mainz am Rhein.
2007 Pottery of the Twelfth to Seventh Centuries BC, 17–59, in: D.G. JEFFREYS and D.A. ASTON (eds.), *The Survey of Memphis III: The Third Intermediate Period Levels*, London.
- ASTON, D.A. and BADER, B. with a contribution by K.G. KUNST
2009 Fishes, Ringstands, Nudes and Hippos – A Preliminary Report on the Hyksos Palace Pit Complex L81, *Ä&L* 19, 19–89.
- BADER, B.
2008 A Late Middle Kingdom Settlement at Tell el-Dab^a and its Potential, 45–64, in: P. KOUSOULIS and N. LAZARIDIS N. (eds.), *Proceedings of the Tenth International Conference of Egyptologists*, OLA 241, Leuven.
- BAVAY, L.
1998 La céramique dans le secteur du parvis de la porte monumentale, 316–332, in: PH. BRISSAUD, C. ZIVIE-COCHE (eds.), *Tanis: travaux récents sur le tell Sân el-Hagar: Mission française des fouilles de Tanis*, Paris.
- BEN-TOR, D.
2007 *Scarabs, Chronology, and Interconnections: Egypt and Palestine in the Second Intermediate Period*, OBO 27, Fribourg/Göttingen.
- BRUNTON, G. and ENGELBACH, R.
1927 *Gurob*, London.
- BUCHHOLZ, H.-G.
1963 Steinerne Dreifußschalen des ägäischen Kulturkreises und ihre Beziehungen zum Osten, *JDAI* 78, 1–74.
- CORNELIUS, I.
2004 *The Many Faces of the Goddess. The Iconography of the Syro-Palestinian Goddesses Anat, Astarte, Qedshet, and Asherah c. 1500-1000 BCE*, OBO 204, Fribourg.
- DEFERNEZ, C.
2001 *La céramique d'époque perse à Tell el-Herr. Étude chrono-typologique et comparative*, Lille.
- DOTHAN, T.
1963 Spinning Bowls. *IEJ* 13(2), 97–112.
- FOSTER, K.P. and BICHLER, M.
2003 Thera Pumice from Egyptian Graves?, 431–439, in: K.P. FOSTER and R. LAFFINEUR (eds.), *METRON: Measuring the Aegean Bronze Age*, Aegaeum 24, Liège/Austen.
- FOSTER, K.P., STERBA, J.H., STEINHAUSER, G. and BICHLER M.
2009 The Thera eruption and Egypt: pumice, texts and chronology, 171–180, in: D.A. WARBURTON (ed.), *Time's Up! Dating the Minoan eruption of Santorini: Acts of the Minoan Eruption Chronology Workshop, Sandbjerg, November 2007, initiated by Jan Heinemeier and Walter L. Friedrich*, MoDIA 10, Athens.
- FORSTNER MÜLLER, I.
2008 *Tell el-Dab^a XVI: Die Gräber des Areals A/II von Tell el-Dab^a*, UZK 28, Vienna.
- GERMER, R.
1985 *Flora des pharaonischen Ägypten*, SDAIK 14, Mainz am Rhein.
- GIDDY, L.
1999 *Kom Rabi'a. The New Kingdom and Post-New Kingdom Objects*. The Survey of Memphis II, London.
- GOEDICKE, H.
1986a Tell el-Maschuta, in: *LÄ* VI, col. 351.
1986b Tell er-Retabe, in: *LÄ* VI, col. 353–354.
- HARTUNG, U., BALLET, P., BÉGUIN, F., BOURRIAU, J., FRENCH, P., HERBICH, T., KOPP, P., LECUYOT, G. and SCHMITT, A.
2003 Tell el-Fara'in-Buto. 8. Vorbericht, *MDAIK* 59, 199–266, pls. 38–46.
- HARTUNG, U., BALLET, P., BÉGUIN, F., BOURRIAU, J., DIXNEUF, D., DRIESCH, A., FRENCH, P., HARTMANN, R., HERBICH, T., KITAGAWA, CH., KOPP, P., LECUYOT, G., NENNA, M., SCHMITT, A., ŞENOL, G. and ŞENOL, A.
2007 Tell el-Fara'in-Buto. 9. Vorbericht, *MDAIK* 63, 69–165, pls. 11–22.
- HARTUNG, U., BALLET, P., EFFLAND, A., FRENCH, P., HARTMANN, R., HERBICH, T., HOFFMANN, H., HOWER-TILMANN, E., KITAGAWA, CH., KOPP, P., KREIBIG, W., LECUYOT, G., LÖSCH, S., MAROUCARD, G., NERLICH, A., PITHON, M. and ZINK, A.
2009 Tell el-Fara'in-Buto. 10. Vorbericht, *MDAIK* 65, 82–190, pls. 20–31.
- HENEIN, N.H.
1992 *Poterie et proverbes d'Égypte*, Cairo.
1997 *Poterie et potiers d'al-Qasr. Oasis de Dakhla*, Cairo.
- HUDEC, J., FULAJTÁR, E. and STOPKOVÁ, E.
2015 Historical, natural and constructional determinations of the fortresses in Tell el-Retaba, *Asian and African Studies* 24(2), 247–283.
- JAMES, F.W. and MCGOVERN, P.E.
1993 *The Late Bronze Egyptian Garrison at Beth Shan. A Study of Levels VII and VIII*, University Museum Monograph 85, Philadelphia.

- JANKOVICH, K.
2008 *Ezbet Helmi, Palastbezirk der Hyksoszeit und des Neuen Reichs: nichtkeramische Funde (Areale Helmi I, III und IV)*, unpublished Master thesis, University of Vienna.
- JÁNOSI, P.
2002 Bericht über die im Frühjahr 2001 erfolgten Sondagen im Dorf Ezbet Helmi (Grabungsfläche H/I), *Ä&L* 12, 195–210.
- JARMUŻEK, Ł.
2010 Loom-weights or net-weights? *GM* 226, 17–24.
- KEEL, O.
1997 *Corpus der Stempelsiegel-Amulette aus Palästina, Israel von den Anfängen bis zur Perserzeit. Katalog-Bd. 1. Von Tell Abu-Farağ bis 'Atilit*, OBO 13, Freiburg.
- KEMP, B.J. and STEVENS, A.
2010 *Busy lives at Amarna: Excavations in the Main City (Grid 12 and the house of Ranefer, N 49,18)*, vol. I: *The Excavations, Architecture and Environmental Remains*; vol. II: *The Objects*, London.
- KERTESZ, T.
1988 Beads and pendants, 203–211, in: ROTHENBERG and BACHMANN 1988.
- KUBÁČKOVÁ, L., KUBÁČEK, L. and KUKUČA, J.
1987 *Probability and Statistics in Geodesy and Geophysics*, Amsterdam.
- LEACH, B. and TAIT, J.
2000 Papyrus, 227–253, in: NICHOLSON and SHAW (eds.) 2000.
- LEE, L. and QUIRKE, S.
2000 Painting Materials, 104–120, in: NICHOLSON and SHAW (eds.) 2000.
- LEHMANN, M.
2011 Vorbericht über die Grabungstätigkeiten der Herbst-Kampagne 2009 im Areal A/II von Tell el-Daba^a, *Ä&L* 25, 47–65.
2012 The city of Avaris after the New Kingdom, *EA* 40, 29–31.
- LE QUESNE, CH.
2007 *Quseir. An Ottoman and Napoleonic Fortress on the Red Sea Coast of Egypt*, Cairo/New York.
- LUCAS, A. and HARRIS, J.R.
1962 *Ancient Egyptian Materials and Industries*, 4th ed. Revised by J.R. Harris, London.
- LUPO, S.
2015 *Tell el-Ghaba III. A Third Intermediate-Early Saite Period Site in the Egyptian Eastern Delta. Excavations 1995-1999 and 2010 in areas I, II, VI and VIII*, BAR/IS 2756, Oxford.
- MAROUARD, G.
2014 Maisons-tours et organisation des quartiers domestiques dans les agglomérations du Delta: l'exemple de Bouto de la Basse Époque aux premiers lagides, in: S. MARCHI (ed.), *Les maisons-tours en Égypte durant la Basse-Époque, les périodes Ptolémaïque et Romaine. Actes de la table-ronde de Paris. Université Paris-Sorbonne (Paris IV)*, 29–30 Novembre, *NeHeT* 2, 105–133.
- MAZAR, A.
1985 Pottery plaques depicting goddesses standing in temple facades, *Michmanim* 2, 5–18.
- MOOREY, P.R.S.
1994 *Ancient Mesopotamian Materials and Industries: The Archaeological evidence*, Oxford.
- MÜLLER-WINKLER, C.
1987 *Die ägyptischen Objekt-Amulette*, OBO SA 5, Fribourg, Switzerland.
- NEWBERRY, P.E.
1907 *Scarab-shaped seals: nos. 36001-37521*, London.
- NICHOLSON, P.T. and PATTERSON, H.
1985 Pottery Making in Upper Egypt. An Ethnoarchaeological Study, *World Archaeology* 17(2), 222–239.
- NICHOLSON, P.T. and SHAW, I. (eds.)
2000 *Ancient Egyptian Materials and Technology*, Cambridge.
- NOUR EL-DIN, M., HULKOVÁ, L., ŠEŘČÁKOVÁ, A., HUDEC, J. and WODZINSKA, A.
2016 Egyptian Mission Rescue Excavations in Tell el-Retaba. Part 2: The Second Intermediate Period Cemetery, *Ä&L* 26, 75–114.
- OGDEN, J.
2000 Metals, 148–176, in: NICHOLSON and SHAW (eds.) 2000.
- PETRIE, W.M.F.
1909 *Memphis I*, London.
1914 *Amulets. Illustrated by the Egyptian collection in University College*, London.
1917 *Tools and Weapons*, London.
1925 *Buttons and Design Scarabs*, BSAE & ERA 38, London.
- PETRIE, W.M.F. and DUNCAN, J.G.
1906 *Hyksos and Israelite Cities*, BSAE & ERA 12, London.
- PHILIP, G.
1989 *Metal Weapons of the Early and Middle Bronze Ages in Syria-Palestine*, BAR/IS 526, Oxford.
2006 *Tell el-Dab^a XV: Metalwork and Metalworking Evidence for the late Middle Kingdom and the Second Intermediate Period*, UZK 26, Vienna.
- PRELL, S.
2011 *Einblicke in die Werkstätten der Residenz: Die Stein- und Metallwerkzeuge des Grabungsplatzes Q I*, FoRa 8, Hildesheim.

- PTC
2017 MathCAD [software]. Online at <http://www.ptc.com/engineering-math-software/mathcad>
- RANKE, H.
1952 *Die Ägyptischen Personennamen*, Vol. II, Glückstadt.
- REDFORD, D.
1982 Pithom, in: *LÄ* IV, col. 1054–1058.
- REDMOUNT, C.A.
1989 *On an Egyptian/Asiatic Frontier: an Archaeological History of the Wadi Tumilat*, unpublished PhD dissertation, University of Chicago.
- REDMOUNT, C.A. and FRIEDMAN, R.
1997 Tales of a Delta Site: The 1995 Field Season at Tell el-Muqdam, *JARCE* 34, 57–83.
- REMONDINO, F. and CAMPANA, F.
2014 *3D Recording and Modelling in Archaeology and Cultural Heritage: Theory and best practices*. Oxford.
- ROTHENBERG, B. and BACHMANN, H.G.
1988 *The Egyptian Mining Temple at Timna*, London.
- ROTTÉ, E.
2012 Egyptian Plaques Terracottas of Standing Nude Women from the Late Period: Egyptian Heritage or Foreign Influences, *Newsletter of the Coroplastic Studies Interest Group* 7, 13–16.
- RUSMORE-VILLAUME, M.
2008 *Seashells of the Egyptian Red Sea*, Cairo.
- RZEPKA, S., WODZIŃSKA, A., HUDEC, J. and HERBICH, T.
2009 Tell el-Retaba 2007–2008, *Ä&L* 19, 241–280.
- RZEPKA, S., WODZIŃSKA, A., MALLESON, C., HUDEC, J., JARMUZEK, L., MISIEWICZ, K., MAŁKOWSKI, W. and BOGACKI, M.
2011 New Kingdom and the Third Intermediate Period in Tell el-Retaba. Results of the Polish-Slovak Archaeological Mission, Seasons 2009–2010, *Ä&L* 21, 139–184.
- RZEPKA, S., HUDEC, J., WODZIŃSKA, A., JARMUZEK, Ł., HULKOVÁ, L., DUBCOVÁ, V., PIORUN, M. and ŠEFČÁKOVÁ, A.
2014 Tell el-Retaba from the Second Intermediate Period till the Late Period: Results of the Polish-Slovak Archaeological Mission, Seasons 2011–2012, *Ä&L* 24, 39–120.
- RZEPKA, S., HUDEC, J., JARMUZEK, Ł., DUBCOVÁ, V., HULKOVÁ, L., ODLER, M., WODZIŃSKA, A., TRZCIŃSKI, J., ŠEFČÁKOVÁ, A., SÓJKA, P., FULAJTÁR, E., ČERNÝ, M. and TIRPÁK, J.
2015 From Hyksos Settlers to Ottoman Pipe Smokers. Tell el-Retaba 2014, *Ä&L* 25, 97–166.
- RZEPKA, S., HUDEC, J., JARMUZEK, Ł., DUBCOVÁ, V., HULKOVÁ, L., ODLER, M., ŠEFČÁKOVÁ, A. and SÓJKA, P.
2016 Tell el-Retaba: 2014–2015, *PAM* 25, 193–226.
- SCHOSKE, S.
1990 *Schönheit - Abglanz der Göttlichkeit. Kosmetik im Alten Ägypten*, Munich.
- SCHULMAN, A.
1988 Catalogue of the Egyptian finds, 114–147, in: ROTHENBERG and BACHMANN 1988.
- SCOTT, D.A.
2016 A Review of Ancient Egyptian Pigments and Cosmetics, *Studies in Conservation* 61(4), 185–202.
- STERBA, J.H., POLINGER FOSTER K., STEINHAUSER G. and BICHLER M.
2009 New Light on Old Pumice: the Origins of Mediterranean Volcanic Material from ancient Egypt, *JAS* 36(8), 1738–1744.
- STOPKOVÁ, E.
2016a *Survey Control Network Retaba 2014*. Technical report, revision 2.
2016b *Spatial data of Tell el-Retaba*. CAD drawing and Metadata based on the Land surveying work by E. Stopková (2014–2016).
2016c Open-Source Tool for Automatic Import of Coded Surveying Data to Multiple Vector Layers in GIS Environment, *Geoinformatics FCE CTU* 15(2), 15–26.
in review *Spatial Information Recovery in the Desert Using LMS-based Geodetic Network Adjustment*.
- TUFNELL, O.
1984 *Scarab Seals and their Contribution to History in the Second Millenium B.C. Studies on Scarab Seals*, Vol. II, Warminster.
- VANDIER D'ABBADIE, J.
1972 *Au Musée du Louvre. Catalogue des Objets de Toilette Égyptiens*, Paris.
- VOGELSANG-EASTWOOD, G.
2000 Textiles, 268–298, in: NICHOLSON and SHAW (eds.) 2000.
- WEATHERHEAD, F.
1995 Two Studies on Amarna Pigments, 384–398, in: B.J. KEMP (ed.), *Amarna Reports VI*, London.
- WEATHERHEAD, F. and BUCKLEY, A.
1989 Artists' Pigments from Amarna, 202–240, in: B.J. KEMP (ed.) *Amarna Reports V*, London.
- WILSON, P.
2011 *Sais I. The Ramesside–Third Intermediate Period at Kom Rebwa*, EES ExcMem. 98, London.
- WODZIŃSKA, A.
2011 Pottery and Chronology. Preliminary Remarks on Ceramic Material from Tell el Retaba, 1015–1036, in: D. ASTON, B. BADER, C. GALLORINI, P. NICHOLSON and S. BUCKINGHAM (eds.), *Under the Potter's Tree. Studies on Ancient Egypt Presented to Janine Bourriau on the Occasion of her 70th Birthday*, OLA 204, Leuven.
- WOODWARD, F.R.
1988 Miscellanea, 260–266, in: ROTHENBERG and BACHMANN 1988.

